

Standard shelving

| PL | Spis treści                 | EN | Contents                | FR | Table des matières     | DE | Inhaltsverzeichnis           | RU | Содержание                  |
|----|-----------------------------|----|-------------------------|----|------------------------|----|------------------------------|----|-----------------------------|
|    | Wprowadzenie                |    | Introduction            |    | Introduction           |    | Einführung                   |    | Введение                    |
| 1  | Spis treści                 | 1  | Contents                | 1  | Table des matières     | 1  | Inhaltsverzeichnis           | 1  | Содержание                  |
| 2  | Wymiary                     | 2  | Dimensions              | 2  | Dimensions             | 2  | Maße                         | 2  | Размеры                     |
| 3  | Oznaczenia                  | 3  | Markings                | 3  | Marquages              | 3  | Kennzeichen                  | 3  | Маркировка                  |
| 4  | Prezentacja                 | 4  | Presentation            | 4  | Présentation           | 4  | Präsentation                 | 4  | Презентация                 |
|    | Elementy Bazowe             |    | Base Elements           |    | Éléments de base       |    | Basiselemente                |    | Базовые Элементы            |
| 7  | Profile i Stopy             | 7  | Uprights & Baselegs     | 7  | Montants et Pieds      | 7  | Säulen und Fußsteile         | 7  | Профиль и Стопа             |
| 8  | Tyły                        | 8  | Back panels             | 8  | Fonds                  | 8  | Rückwände                    | 8  | Задние стенки               |
| 12 | Półki i wsporniki           | 12 | Shelves & Brackets      | 12 | Tablettes et Console   | 12 | Fachböden und Konsolen       | 12 | Полки и кронштейны          |
| 14 | Regał - słup dołączany      | 14 | Add-on Shelving         | 14 | Rayon - montant avancé | 14 | Regal mit Vorstecksäule      | 14 | Стеллажи с передней стойкой |
| 18 | Dostawki                    | 18 | End-Caps                | 18 | Têtes de gondole       | 18 | Kopfregal                    | 18 | Торцы                       |
|    | Akcesoria                   |    | Accessories             |    | Accessoires            |    | Zubehör                      |    | Аксессуары                  |
| 22 | Przegrody i listwy frontowe | 22 | Dividers & Front Risers | 22 | Séparateurs et lattes  | 22 | Trenngittern und Frontgitter | 22 | Перегородки и ограждения    |
| 24 | Kosze                       | 24 | Baskets                 | 24 | Paniers                | 24 | Einhängkörbe                 | 24 | Корзины                     |
| 26 | Belki i Wieszaki            | 26 | Bars & Hooks            | 26 | Barres et Broches      | 26 | Trageschienen und Halter     | 26 | Балки и крючки для балок    |
| 30 | Wieszaki EURO               | 30 | Hooks EURO              | 30 | Broches EURO           | 30 | Halter EURO                  | 30 | Крючки (EURO)               |
| 32 | Wieszaki PANEL/SW           | 32 | Hooks PANEL/SW          | 32 | Broches FONDS LAMES    | 32 | Halter PANEELE/SW            | 32 | Крючки-панели/spacewall     |
|    | Elementy Inne               |    | Other Elements          |    | Autres Eléments        |    | Andere Elemente              |    | Другие Элементы             |
| 34 | Regały narożne              | 34 | Corners                 | 34 | Rayons d'angle         | 34 | Eckregale                    | 34 | Угловые стеллажи            |
| 40 | Rozwiązania dedykowane      | 40 | Dedicated solutions     | 40 | Solutions dédiées      | 40 | Dedizierte Lösungen          | 40 | Специализированные решения  |
| 42 | Ostony                      | 42 | Covers & Plinths        | 42 | Caches et plintes      | 42 | Abschlußdeckungen            | 42 | Крышки и плинтусы           |
| 43 | Kotwy, inne                 | 43 | Anchors, others         | 43 | Ancres, autres         | 43 | Montageanker, andere         | 43 | Крепления и Другие          |
| 45 | Kolory                      | 45 | Colours                 | 45 | Couleurs               | 45 | Farben                       | 45 | Цвета                       |

Katalog udostępniany jest bezpłatnie i ma charakter informacyjny - nie jest ofertą handlową w rozumieniu art. 66 §1 KoWdoku Cywilnego. Producent zastrzega sobie prawo dokonywania zmian w specyfikacji technicznej produktu bez uprzedzającej informacji.

The catalogue is free of charge and available for information purposes only - it is not an offer. The manufacturer reserves the right to modify the technical specifications of the product without prior notice.

Le catalogue est gratuit et est créé pour les fins de l'information - il ne constitue pas l'offre commerciale selon la définition de l'art. 66 § 1 du Code Civil. Le producteur se réserve le droit aux modifications de la spécification technique du produit sans l'information préalable.

Das Katalog wird kostenlos zur Verfügung gestellt und hat einen Informationscharakter. Es ist kein Handelsangebot im Sinne von Art. 66 §1 des Bürgerlichen Gesetzbuches. Der Produzent behält sich das Recht auf die Vornahme der Änderungen in der technischen Spezifikation des Produktes ohne vorherige Vorlage der Information vor.

Каталог бесплатный и носит исключительно информационный характер - не является торговым предложением. Производитель оставляет за собой право вносить изменения в техническую спецификацию изделия без предварительного уведомления.

Wszystkie podane wymiary są nominalne. Jeśli wymagane są dokładne wymiary, proszę skontaktować się z przedstawicielem handlowym firmy Smartline

All dimensions are nominal. If exact dimensions are required, please contact your Smartline repre-sentative.

Les dimensions données sont les dimensions commerciales. Si vous avez besoin d'une dimension exacte, nous vous prions de bien vouloir contacter le représentant commercial de Smartline.

Alle angegebenen Abmessungen sind nominal. Falls genaue Maße erforderlich, bitte einen Smartline Vertreter kontaktieren.

Все размеры номинальные. Если вам необходимы точные размеры, обратитесь к торговому представителю Smartline.



# Maße Размеры Dimensions Wymiary Dimensions

W celu ułatwienia doboru elementów występujących w niniejszym opracowaniu posługujemy się następującym systemem oznaczeń wymiarów:

H – wymiary handlowe w kierunku wysokości regału

D – wymiary handlowe w kierunku głębokości regału

L – wymiary handlowe w kierunku długości regału

Aby ustalić wymiary zewnętrzne lub wewnętrzne elementów należy zapoznać się z rysunkami zawierającymi te informacje odniesione do właściwego wymiaru handlowego lub zwrócić się o wyjaśnienie do Producenta..

In order to make the selection of elements more clearly, we use the indications listed below:

H - rack height „trade” dimensions

D - rack depth „trade” dimensions

L - rack length „trade” dimensions

To determine the external or internal dimensions of the elements, please refer to the drawings containing the information referenced to the appropriate „trade” size or ask the manufacturer to clarify the information.

Afin de faciliter la sélection des éléments présents dans ce catalogue, nous utilisons les indications de dimensions:

H - dimensions du produit dans le sens de la hauteur de la gondole

D - dimensions du produit dans le sens de la profondeur de la gondole

L - Rack Länge Dimensionen

Pour déterminer les dimensions internes ou externes des composants, reportez-vous aux dessins contenant les informations référencées à la taille commerciale appropriée, ou demandez-nous des informations complémentaires.

Um die Auswahl der Elemente aus unserem Folder zu erleichtern, verwenden wir folgende Maßzeichnungen:

H- Abmessung in Richtung Regalhöhe

D- Abmessung in Richtung Regalbreite

L- Abmessung in Richtung Regallänge

Um die innere und äußere Abmessungen der Elemente festzustellen, ist es empfehlenswert, sich mit den Zeichnungen, die die Informationen beinhalten, vertraut zu machen oder den Hersteller danach zu fragen.

Для упрощения подбора элементов в техническом каталоге используем перечисленные ниже обозначения размеров: H - высота торгового стеллажа D - глубина торгового стеллажа L - длина торгового стеллажа

Чтобы определить внешние или внутренние размеры элементов посмотрите чертежи, которые содержат эту информацию в отношении к соответствующему коммерческому размеру, или обратитесь за пояснениями к производителю.



Wszystkie podane wymiary są nominalne. Jeśli wymagane są dokładne wymiary, proszę skontaktować się z przedstawicielem handlowym firmy Smartline

All dimensions are nominal. If exact dimensions are required, please contact your Smartline repre-sentative.

Les dimensions données sont les dimensions commerciales. Si vous avez besoin d'une dimension exacte, nous vous prions de bien vouloir contacter le représentant commercial de Smartline.

Alle angegebenen Abmessungen sind nominal. Falls genaue Maße erforderlich, bitte einen Smartline Vertreter kontaktieren.

Все размеры номинальные. Если вам необходимы точные размеры, обратитесь к торговому представителю Smartline.

System Standard shelving
25

H- 2100
L- 1000
D- 570

**Wire Baskets**

| 1 PÓŁKA DRUCIANA • Wire shelf • Tablette fil<br>Gitterboden • Пломка сетчатая |     |                 |  |
|---|-----|-----------------|--|
| L   | D   | Code            |  |
| 665   | 370 | MM-D06370665-00 |  |
| 665   | 470 | MM-D06470665-00 |  |
| 665   | 570 | MM-D06570665-00 |  |

| 1 FIXED TILTED • Wire shelf • Tablette fil<br>Gitterboden • Пломка сетчатая |     |                 |  |
|---|-----|-----------------|--|
| L   | D   | Code            |  |
| 1000  | 370 | MM-D06371000-00 |  |
| 1000  | 470 | MM-D06471000-00 |  |
| 1000  | 570 | MM-D06571000-00 |  |

| 1 FIXED TILTED • Wire shelf • Tablette fil<br>Gitterboden • Пломка сетчатая |     |                 |  |
|---|-----|-----------------|--|
| L   | D   | Code            |  |
| 1250  | 370 | MM-D06371250-00 |  |
| 1250  | 470 | MM-D06471250-00 |  |
| 1250  | 570 | MM-D06571250-00 |  |

| 1 FIXED TILTED • Wire shelf • Tablette fil<br>Gitterboden • Пломка сетчатая |     |                 |  |
|---|-----|-----------------|--|
| L   | D   | Code            |  |
| 1330  | 370 | MM-D06371330-00 |  |
| 1330  | 470 | MM-D06471330-00 |  |
| 1330  | 570 | MM-D06571330-00 |  |

| 2 Listwa cenowa • Price strip<br>Prite-diquette • Preisschiene • Ценникдержатель |                 |  |  |
|--|-----------------|--|--|
| L  | Code            |  |  |
| 250  | ME-C00300250-89 |  |  |

# Kennzeichen Маркировка Marquages Oznaczenia Markings

**1**  
Na wizualizacjach wyróżniono kolorem niebieskim elementy których kody oraz podstawowe wymiary podane zostały w tabelach.

**1**  
On the visualizations the blue colour indicates elements, which codes and dimensions are listed in tables.

**1**  
Sur les visualisations en couleur bleue les éléments dont les codes et les dimensions de base ont été indiquées dans le tableau.

**1**  
In den Visualisierungen wurden blaufarbig Elemente gekennzeichnet, deren Codes und Grundabmessungen in den nachstehenden Tabellen.

**1**  
На визуализациях выделены синим цветом элементы, коды которых, а также основные размеры указаны в таблицах.

Wszystkie podane wymiary są nominalne. Jeśli wymagane są dokładne wymiary, proszę skontaktować się z przedstawicielem handlowym firmy Smartline.

All dimensions are nominal. If exact dimensions are required, please contact your Smartline repre-sentative.

Les dimensions données sont les dimensions commerciales. Si vous avez besoin d'une dimension exacte, nous vous prions de bien vouloir contacter le représentant commercial de Smartline.

Alle angegebenen Abmessungen sind nominal. Falls genaue Messe erforderlich, bitte einen Smartline Vertreter kontaktieren.

Все размеры номинальные. Если вам необходимы точные размеры, обратитесь к торговому представителю Smartline.

### Twoja szansa na sukces w handlu!

Dużo przestrzeni na towary i otwarte przejścia dla Klientów. Obroty i zyski kontra ograniczone budżety. Bezlitosna walka pomiędzy wizualnymi konceptami i technicznymi oczekiwaniami.

Standard shelving to poczucie przestrzeni premium.

Ekspozowanie zalet Państwa produktów, Standard shelving oddziałuje na emocje klientów, od prostego regału po kompleksową aranżację sklepu.

Podstawowymi słupami wykorzystywanymi w systemie Standard shelving są słupy o przekrojach 30x60mm, 30x80mm oraz 30x110mm dwustronnie perforowane o skoku perforacji 50mm.

### Your chance for success in the trade!

Roomy space for goods and open aisles for customers. Turnover & profit vs investment budget cuts. Ruthless battle between visual concepts and technical expectations.

Standard shelving ensures a sense of premium interiors highlights advantages of your products Standard shelving stimulates customers' emotions, from simple shelving to the complex arrangement of the store.

Main cross-section of Uprights used in Standard shelving are 30 x 60mm, 30 x 80mm and 30 x 110mm two side perforated with perforation pitch 50.

### C'est ta chance pour le succès du commerce!

Un grand espace pour les produits ainsi que des vastes couloirs pour les clients. Le Chiffre d'affaires et les bénéfices par rapport aux budgets limités.

Standard shelving c'est un sentiment d'espace de luxe. Exposition des avantages de vos produits, Standard shelving influence les émotions des clients, du simple rayon au complexe aménagement du magasin.

Les montants standards utilisés dans le système Standard shelving sont de section: 30x60mm, 30x80mm ainsi que 30x110mm bilatéralement perforés, perforation 50mm.

Standard shelving ist ein premium Raum-gefühl hebt die Vorteile Ihrer Pro-dukte hervor, Standard shelving bewegt die Gemüter, vom einfachen Regal bis zur komplexen Ladenausstattung.

Standardquerschnitt von Säulen im System Standard shelving 30x60mm, 30x80mm und 30x110mm, zweiseitig gelocht mit 50mm Schlitzung

Много места для товаров и свободный переход для клиентов. Оборот и прибыль по сравнению с ограниченным бюджетом. Беспощадная борьба между визуальными концепциями и техническими ожиданиями.

Standard shelving это чувство пространства в версии премиум. Standard shelving полезно влияет на эмоции клиентов и подчеркивает преимущества Ваших товаров, Начиная с простого стеллажа, заканчивая на комплексной аранжации магазина.

Основными стойками системы Standard shelving являются профили 30x60mm, 30x80mm и 30x110mm с двухсторонней перфорацией и шагом 50 мм.

## Standard shelving

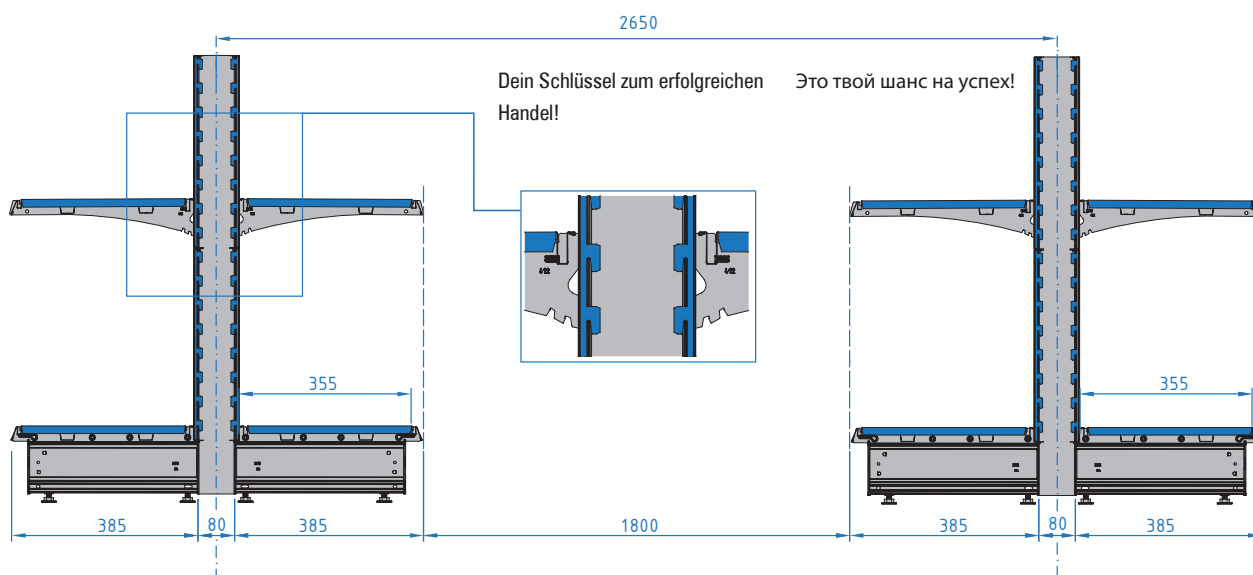



Wszystkie podane wymiary są nominalne. Jeśli wymagane są dokładne wymiary, proszę skontaktować się z przedstawicielem handlowym firmy Smartline

All dimensions are nominal. If exact dimensions are required, please contact your Smartline repre-sentative.

Les dimensions données sont les dimensions commerciales. Si vous avez besoin d'une dimension exacte, nous vous prions de bien vouloir contacter le représentant commercial de Smartline.

Alle angegebenen Abmessungen sind nominal. Falls genaue Maße erforderlich, bitte einen Smartline Vertreter kontaktieren.

Все размеры номинальные. Если вам необходимы точные размеры, обратитесь к торговому представителю Smartline.

W systemie Standard shelving standardowe wymiary półki to 370mm, 470mm, 570mm. Proponowane szerokości regałów, dające możliwość optymalnego wykorzystania przestrzeni sprzedażowej sklepów to 665, 1000, 1250 oraz 1330mm.

Standard shelving standard shelves dimensions are 370mm, 470mm, 570mm. Proposed shelving bays widths providing optimal usage of stores selling space are 665, 1000, 1250 and 1330mm.

Les dimensions standards des tablettes utilisées dans le système Standard shelving sont 370mm, 470mm, 570mm. Les largeurs proposées des rayons 665, 1000, 1250 et 1330mm offrent la possibilité de l'utilisation optimale de l'espace du magasin.

Für optimale Nutzung von Verkaufsf lächen sind die Standardgrößen von Fachb den die Tiefen 370, 470, 570 und die Längen 665mm, 1000mm, 1250mm, 1330mm.

Для оптимального использования пространства магазина предлагаем стандартные размеры полок 370мм, 470мм, 570мм... и длины стеллажей 665, 1000, 1250 и 1330мм.

Stopa podstawowa systemu Standard shelving ma wysokość 160mm i służy do budowania standardowych regałów oraz dostawek i regałów ze słupkami dołączanymi.

Baseleg of Standard shelving system height is 160mm and is used to build standard shelvings as well as shelving with add-on profiles and end-caps.

Le pied standard du système Standard shelving est de la hauteur 160mm et sert construire de rayons standards ainsi que les ttes de gondoles avec les montants rajoutés.

Das Fußteil im Standard shelving 60mm und wird bei Standardregalen, Kopfregealen und Regalen mit einer Frontsäule verwendet.

Стандартная стопа системы Standard shelving имеет высоту 160мм. Благодаря ей без проблем можно собрать стандартный и торцевой стеллаж, с передней стойкой и без нее.

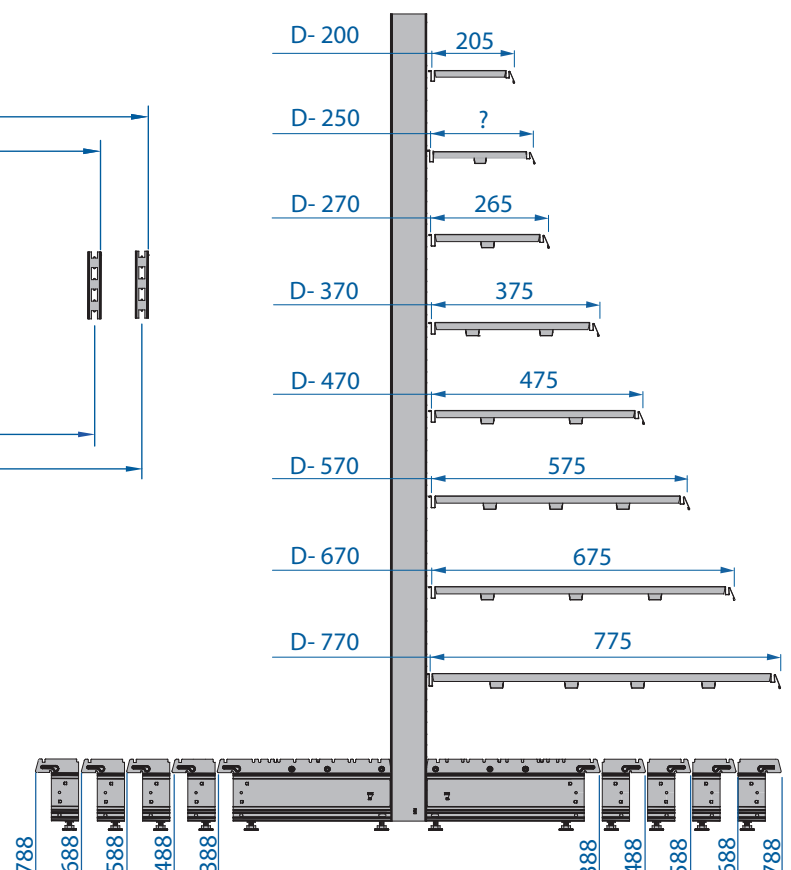
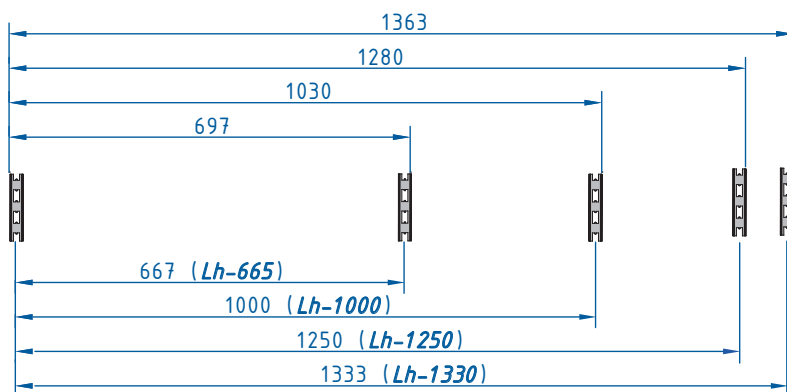



Базовые элементы  
Basiselemente  
Éléments de base  
**Base elements**  
Elementy bazowe

H- 2100

L- 1000

D-570

## Uprights & Base-legs

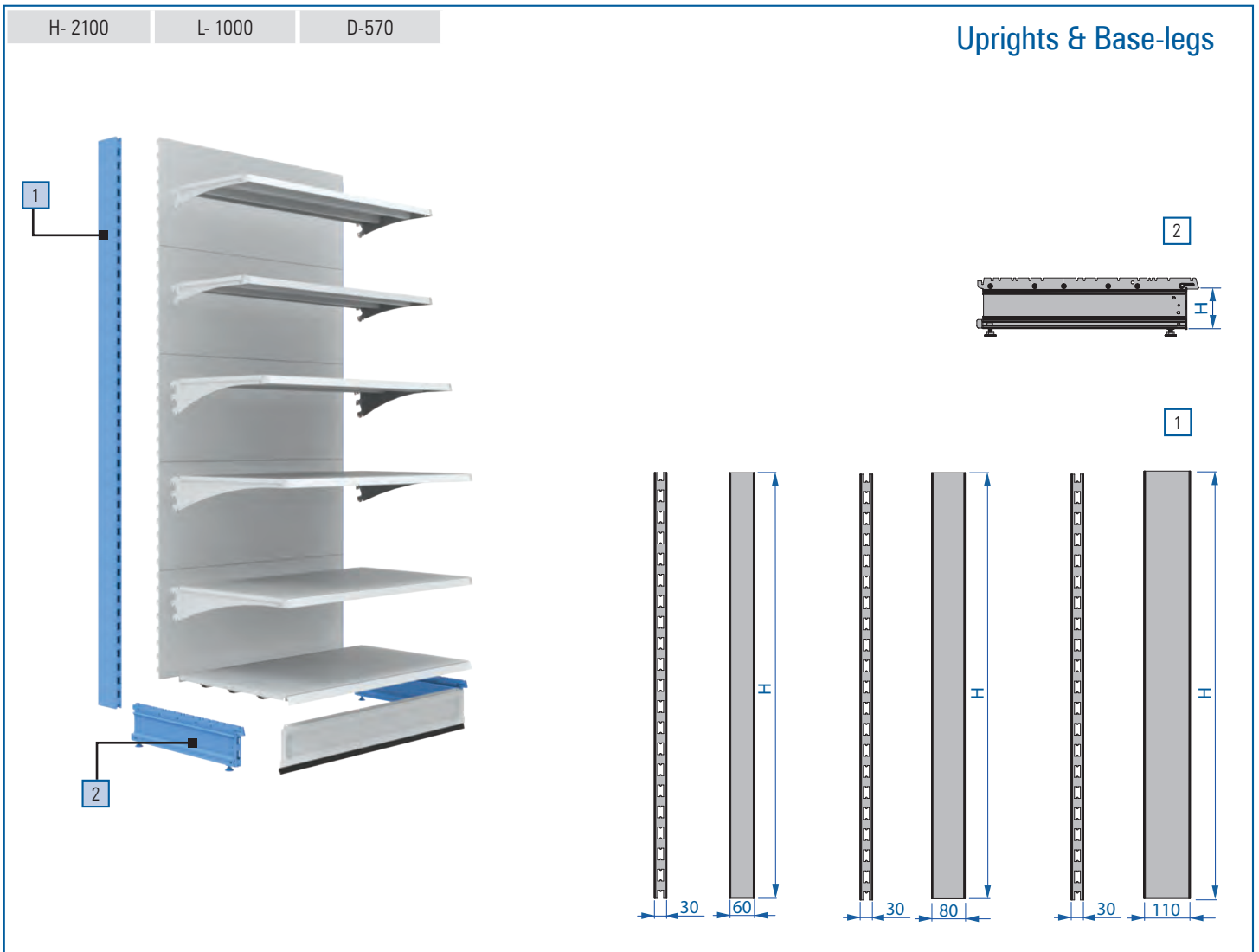

**1 60 × 30**  
Slup • Upright • Montant • Säule • Профиль

| H    | Code            |
|------|-----------------|
| 1400 | TE-N07006140-00 |
| 1600 | TE-N07006160-00 |
| 1800 | TE-N07006180-00 |
| 2000 | TE-N07006200-00 |
| 2100 | TE-N07006210-00 |
| 2200 | TE-N07006220-00 |
| 2400 | TE-N07006240-00 |
| 2600 | TE-N07006260-00 |
| 2800 | TE-N07006280-00 |
| 3000 | TE-N07006300-00 |

**1 80 × 30**  
Slup • Upright • Montant • Säule • Профиль

| H    | Code            |
|------|-----------------|
| 1400 | TE-N07008140-00 |
| 1600 | TE-N07008160-00 |
| 1800 | TE-N07008180-00 |
| 2000 | TE-N07008200-00 |
| 2100 | TE-N07008210-00 |
| 2200 | TE-N07008220-00 |
| 2400 | TE-N07008240-00 |
| 2600 | TE-N07008260-00 |
| 2800 | TE-N07008280-00 |
| 3000 | TE-N07008300-00 |

**1 110 × 30**  
Slup • Upright • Montant • Säule • Профиль

| H    | Code            |
|------|-----------------|
| 1800 | TE-N07011180-00 |
| 2000 | TE-N07011200-00 |
| 2200 | TE-N07011220-00 |
| 2400 | TE-N07011240-00 |

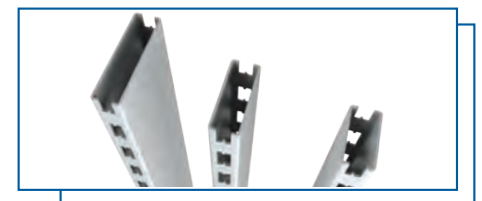

**2 H - 160**  
Stopa • Baseleg • Pied • Fußteil • Стопа

| H   | Code            |
|-----|-----------------|
| 370 | TE-N96337011-00 |
| 470 | TE-N96347011-00 |
| 570 | TE-N96357011-00 |
| 670 | TE-N96367011-00 |
| 770 | TE-N96377011-00 |





H- 1600

L- 1000

D-570

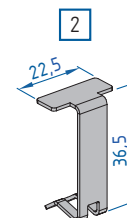
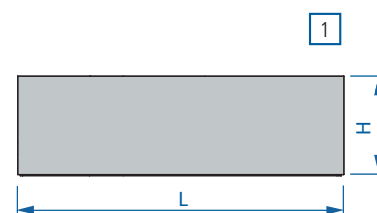
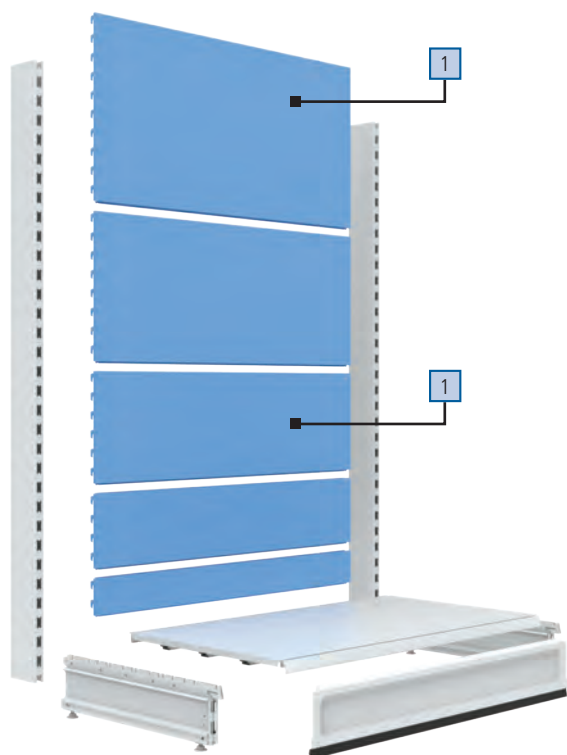
**Back panels**  
**Plain**

**1 PLAIN**  
 Tyły • Back panels • Fond • Rückwände • Задние стенки

| L   | H   | Code            |
|-----|-----|-----------------|
| 600 | 100 | TE-T20100600-00 |
| 600 | 200 | TE-T20200600-00 |
| 600 | 300 | TE-T20300600-00 |
| 600 | 400 | TE-T20400600-00 |
| 600 | 500 | TE-T20500600-00 |

|     |     |                 |
|-----|-----|-----------------|
| 665 | 100 | TE-T20100665-00 |
| 665 | 200 | TE-T20200665-00 |
| 665 | 300 | TE-T20300665-00 |
| 665 | 400 | TE-T20400665-00 |
| 665 | 500 | TE-T20500665-00 |

|     |     |                 |
|-----|-----|-----------------|
| 800 | 100 | TE-T20100800-00 |
| 800 | 200 | TE-T20200800-00 |
| 800 | 300 | TE-T20300800-00 |
| 800 | 400 | TE-T20400800-00 |
| 800 | 500 | TE-T20500800-00 |

**1 PLAIN**  
 Tyły • Back panels • Fond • Rückwände • Задние стенки

| L    | H   | Code            |
|------|-----|-----------------|
| 1000 | 100 | TE-T20101000-00 |
| 1000 | 200 | TE-T20201000-00 |
| 1000 | 300 | TE-T20301000-00 |
| 1000 | 400 | TE-T20401000-00 |
| 1000 | 500 | TE-T20501000-00 |

|      |     |                 |
|------|-----|-----------------|
| 1250 | 100 | TE-T20101250-00 |
| 1250 | 200 | TE-T20201250-00 |
| 1250 | 300 | TE-T20301250-00 |
| 1250 | 400 | TE-T20401250-00 |
| 1250 | 500 | TE-T20501250-00 |

|      |     |                 |
|------|-----|-----------------|
| 1330 | 100 | TE-T20101330-00 |
| 1330 | 200 | TE-T20201330-00 |
| 1330 | 300 | TE-T20301330-00 |
| 1330 | 400 | TE-T20401330-00 |
| 1330 | 500 | TE-T20501330-00 |

**2 P50** • Zabezpieczenie • Safety lock  
 Antidécrochement de fond • Sicherung • Фиксатор

| Code            |
|-----------------|
| ME-A05070050-50 |

H- 1700

L- 1000

D-570

## Back panels EURO Perforated

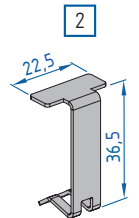
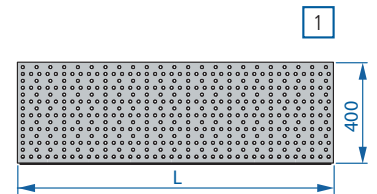
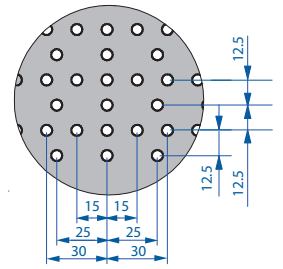
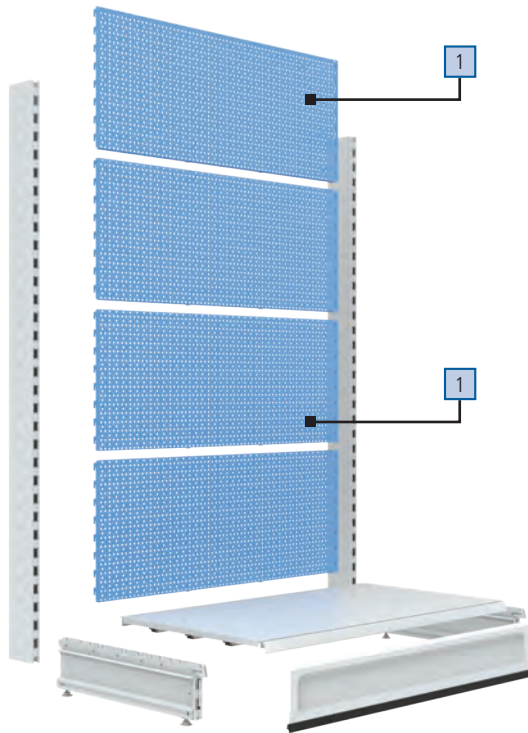

**1 EURO**  
Tyty • Back panels • Fonds • Rückwände • Задние стенки

| L    | H   | Code            |
|------|-----|-----------------|
| 665  | 400 | TE-T21400665-00 |
| 1000 | 400 | TE-T21401000-00 |
| 1250 | 400 | TE-T21401250-00 |
| 1330 | 400 | TE-T21401330-00 |

**2 P50** • Zabezpieczenie • Safety lock •  
Antidécrochement de fond • Sicherung • Фиксатор

| Code            |
|-----------------|
| ME-A05070050-50 |

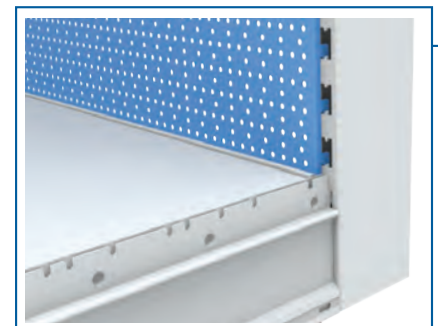
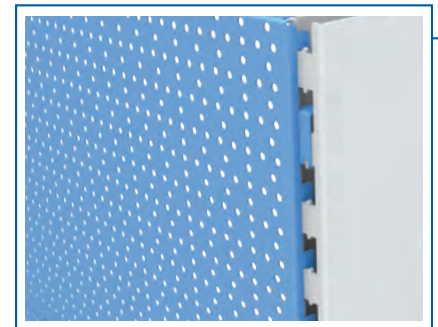

H- 1700

L- 1000

D-570

## Back panels

### Panel

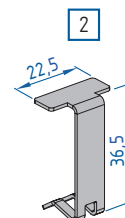
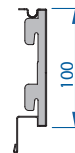

1

**PANEL**

Tyły • Back panels • Fonds • Rückwände • Задние стенки

| L    | H   | Code            |
|------|-----|-----------------|
| 665  | 100 | MP-T54100665-00 |
| 1000 | 100 | MP-T54101000-00 |
| 1250 | 100 | MP-T54101250-00 |
| 1330 | 100 | MP-T54101330-00 |

2

**P50** • Zabezpieczenie • Safety lock

Antidécrochement de fond • Sicherung • Фиксатор

| Code            |
|-----------------|
| ME-A05070050-50 |





H- 2100

L- 1000

D-470

## Shelves & Brackets

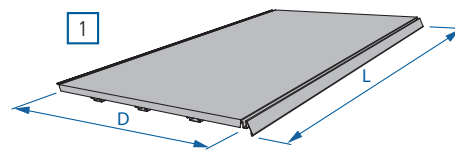
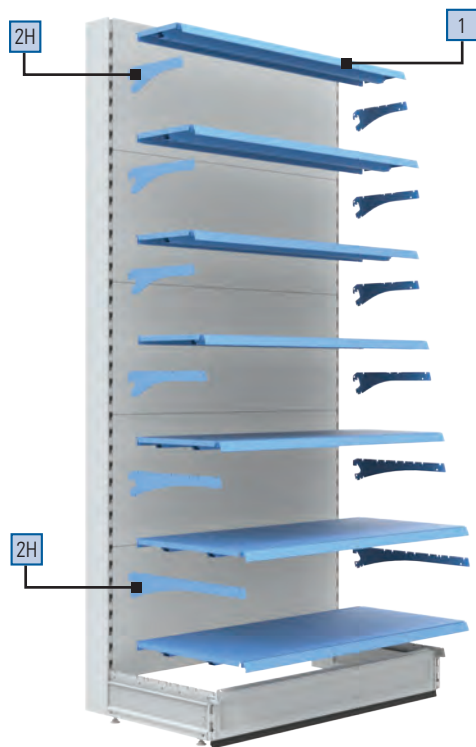

D - 200

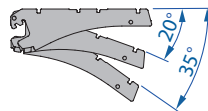

D - 250

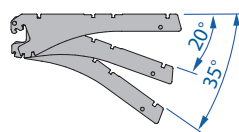

D - 270

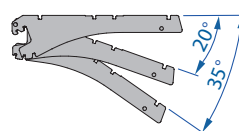

2H

D - 300

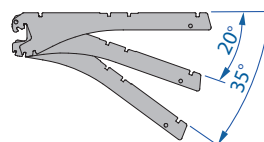

D - 370

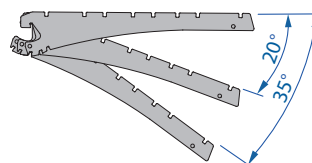

D - 470

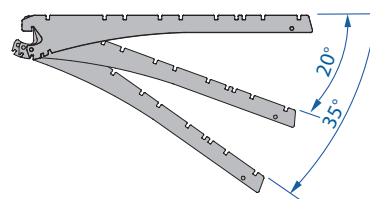

1

### CLASSIC

Półka • Shelf • Tablette • Fachboden • Полка

| L   | D   | Reinforcements | Code            |
|-----|-----|----------------|-----------------|
| 600 | 200 | 1              | NE-P00200600-00 |
| 600 | 250 | 1              | NE-P00250600-00 |
| 600 | 270 | 1              | NE-P00270600-00 |
| 600 | 300 | 1              | NE-P00300600-00 |
| 600 | 370 | 2              | NE-P00370600-00 |
| 600 | 470 | 2              | NE-P00470600-00 |
| 665 | 200 | 1              | NE-P00200665-00 |
| 665 | 250 | 1              | NE-P00250665-00 |
| 665 | 270 | 1              | NE-P00270665-00 |
| 665 | 300 | 1              | NE-P00300665-00 |
| 665 | 370 | 2              | NE-P00370665-00 |
| 665 | 470 | 2              | NE-P00470665-00 |
| 800 | 200 | 1              | NE-P00200800-00 |
| 800 | 250 | 1              | NE-P00250800-00 |
| 800 | 270 | 1              | NE-P00270800-00 |
| 800 | 300 | 1              | NE-P00300800-00 |
| 800 | 370 | 2              | NE-P00370800-00 |
| 800 | 470 | 2              | NE-P00470800-00 |

1

### CLASSIC

Półka • Shelf • Tablette • Fachboden • Полка

| L    | D   | Reinforcements | Code            |
|------|-----|----------------|-----------------|
| 1000 | 200 | 1              | NE-P00201000-00 |
| 1000 | 250 | 1              | NE-P00251000-00 |
| 1000 | 270 | 1              | NE-P00271000-00 |
| 1000 | 300 | 1              | NE-P00301000-00 |
| 1000 | 370 | 2              | NE-P00371000-00 |
| 1000 | 470 | 2              | NE-P00471000-00 |
| 1250 | 200 | 1              | NE-P00201250-00 |
| 1250 | 250 | 1              | NE-P00251250-00 |
| 1250 | 270 | 1              | NE-P00271250-00 |
| 1250 | 300 | 1              | NE-P00301250-00 |
| 1250 | 370 | 2              | NE-P00371250-00 |
| 1250 | 470 | 3              | NE-P00471250-00 |
| 1330 | 200 | 1              | NE-P00201330-00 |
| 1330 | 250 | 1              | NE-P00251330-00 |
| 1330 | 270 | 1              | NE-P00271330-00 |
| 1330 | 300 | 1              | NE-P00301330-00 |
| 1330 | 370 | 2              | NE-P00371330-00 |
| 1330 | 470 | 3              | NE-P00471330-00 |

2H

### ADJUSTABLE

Wspornik • Bracket • Console • Konsole • Кронштейн

| D   | Code            |
|-----|-----------------|
| 200 | ME-W10010200-00 |
| 250 | ME-W10010250-00 |
| 270 | ME-W10010270-00 |
| 300 | ME-W10010300-00 |
| 370 | ME-W10010370-00 |
| 470 | ME-W12240470-00 |

H- 2100 L- 1000 D-770

## Shelves & Brackets

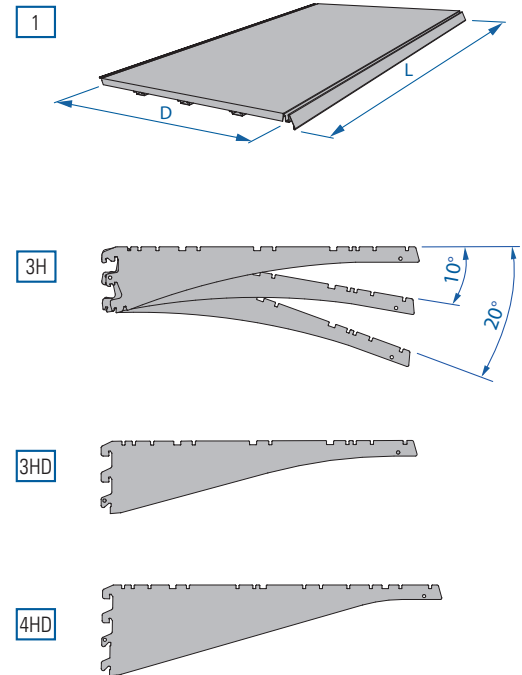
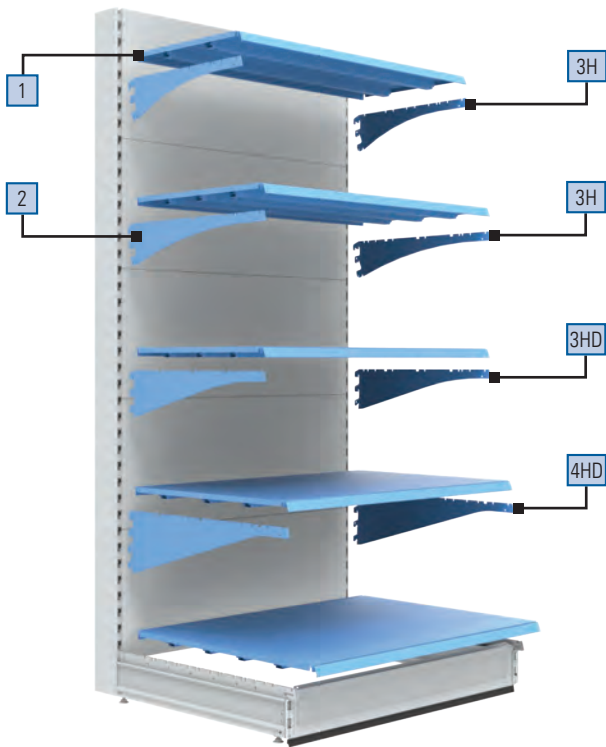

**1 CLASSIC**  
Półka • Shelf • Tablette • Fachboden • Полка

| L   | D   | Reinforcements | Code            |
|-----|-----|----------------|-----------------|
| 600 | 470 | 2              | NE-P00470600-00 |
| 600 | 570 | 3              | NE-P00570600-00 |
| 600 | 670 | 3              | NE-P00670600-00 |
| 600 | 770 | 4              | NE-P00770600-00 |
| 665 | 470 | 2              | NE-P00470665-00 |
| 665 | 570 | 3              | NE-P00570665-00 |
| 665 | 670 | 3              | NE-P00670665-00 |
| 665 | 770 | 4              | NE-P00770665-00 |
| 800 | 470 | 2              | NE-P00470800-00 |
| 800 | 570 | 3              | NE-P00570800-00 |
| 800 | 670 | 3              | NE-P00670800-00 |
| 800 | 770 | 4              | NE-P00770800-00 |

**1 CLASSIC**  
Półka • Shelf • Tablette • Fachboden • Полка

| L    | D   | Reinforcements | Code            |
|------|-----|----------------|-----------------|
| 1000 | 470 | 2              | NE-P00471000-00 |
| 1000 | 570 | 3              | NE-P00571000-00 |
| 1000 | 670 | 3              | NE-P00671000-00 |
| 1000 | 770 | 4              | NE-P00771000-00 |
| 1250 | 470 | 3              | NE-P00471250-00 |
| 1250 | 570 | 3              | NE-P00571250-00 |
| 1250 | 670 | 3              | NE-P00671250-00 |
| 1250 | 770 | 4              | NE-P00771250-00 |
| 1330 | 470 | 3              | NE-P00471330-00 |
| 1330 | 570 | 3              | NE-P00571330-00 |
| 1330 | 670 | 3              | NE-P00671330-00 |
| 1330 | 770 | 4              | NE-P00771330-00 |

**3H ADJUSTABLE**  
Wspornik • Bracket • Console • Konsole • Кронштейн

| D   | Code            |
|-----|-----------------|
| 470 | ME-W10010470-00 |
| 570 | ME-W10010570-00 |

**3HD STRAIGHT**  
Wspornik • Bracket • Console • Konsole • Кронштейн

| D   | Code            |
|-----|-----------------|
| 470 | ME-W10030470-00 |
| 570 | ME-W10030570-00 |
| 670 | ME-W10030670-00 |

**4HD STRAIGHT**  
Wspornik • Bracket • Console • Konsole • Кронштейн

| D   | Code            |
|-----|-----------------|
| 570 | ME-W10020570-00 |
| 670 | ME-W10020670-00 |
| 770 | ME-W10020770-00 |

H- 2100

L- 1330

D-570

## Uprights & Base-legs Add-on ONE

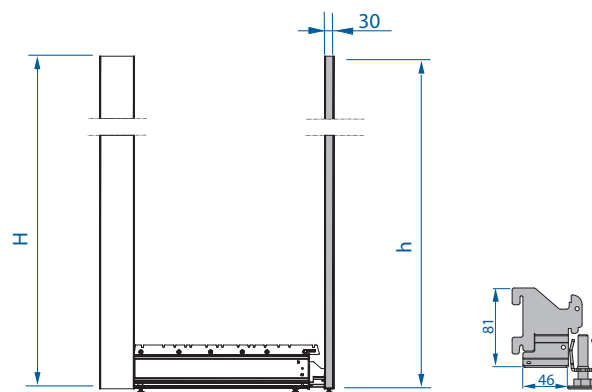
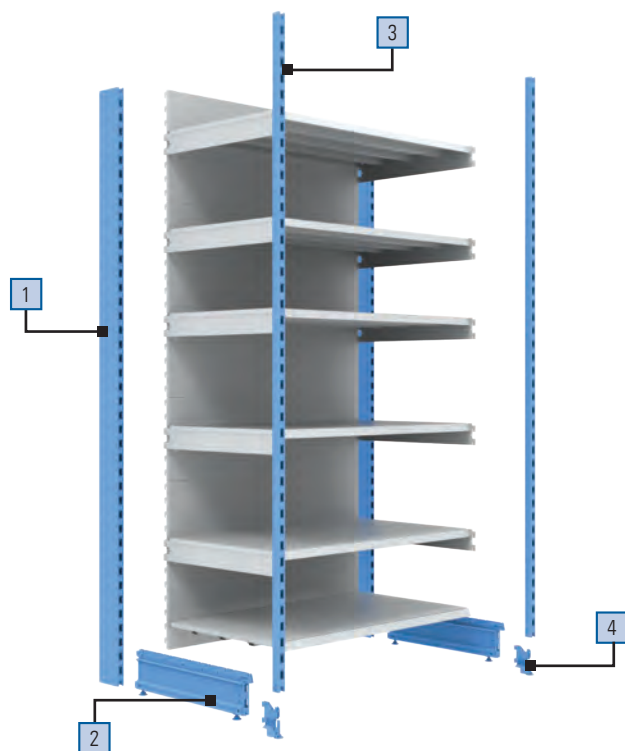

### 1 60 × 30

Slup • Add-on upright • Montant • Säule • Профиль

| H    | Code            |
|------|-----------------|
| 1100 | TE-N07006110-00 |
| 1200 | TE-N07006120-00 |
| 1400 | TE-N07006140-00 |
| 1600 | TE-N07006160-00 |
| 1800 | TE-N07006180-00 |
| 2000 | TE-N07006200-00 |
| 2100 | TE-N07006210-00 |
| 2200 | TE-N07006220-00 |
| 2400 | TE-N07006240-00 |
| 2600 | TE-N07006260-00 |
| 2800 | TE-N07006280-00 |
| 3000 | TE-N07006300-00 |

### 1 80 × 30

Slup • Add-on upright • Montant • Säule • Профиль

| H    | Code            |
|------|-----------------|
| 1400 | TE-N07008140-00 |
| 1600 | TE-N07008160-00 |
| 1800 | TE-N07008180-00 |
| 2000 | TE-N07008200-00 |
| 2100 | TE-N07008210-00 |
| 2200 | TE-N07008220-00 |
| 2400 | TE-N07008240-00 |
| 2600 | TE-N07008260-00 |
| 2800 | TE-N07008280-00 |
| 3000 | TE-N07008300-00 |

### 3 FRONT 30 × 30

Slup • Add-on upright • Montant • Säule • Профиль

| H    | h    | Code            |
|------|------|-----------------|
| 1300 | 1300 | TE-N07003130-00 |
| 1400 | 1400 | TE-N07003140-00 |
| 1500 | 1500 | TE-N07003150-00 |
| 1600 | 1600 | TE-N07003160-00 |
| 1700 | 1700 | TE-N07003170-00 |
| 1800 | 1800 | TE-N07003180-00 |
| 1900 | 1900 | TE-N07003190-00 |
| 2000 | 2000 | TE-N07003200-00 |
| 2100 | 2100 | TE-N07003210-00 |
| 2200 | 2200 | TE-N07003220-00 |
| 2300 | 2300 | TE-N07003230-00 |
| 2400 | 2400 | TE-N07003240-00 |
| 2500 | 2500 | TE-N07003250-00 |
| 2600 | 2600 | TE-N07003260-00 |
| 3000 | 3000 | TE-N07003300-00 |

### 2 H - 160

Stopa • Baseleg • Pied • Fußteil • Crona

| D   | Code            |
|-----|-----------------|
| 370 | TE-N96337011-00 |
| 470 | TE-N96347011-00 |
| 570 | TE-N96357011-00 |
| 670 | TE-N96367011-00 |
| 770 | TE-N96377011-00 |

### 1 110 × 30

Slup • Add-on upright • Montant • Säule • Профиль

| H    | Code            |
|------|-----------------|
| 1800 | TE-N07011180-00 |
| 2000 | TE-N07011200-00 |
| 2200 | TE-N07011220-00 |
| 2400 | TE-N07011240-00 |

### 4 Adapter • Adapter • Adapteur • Adapter • Адаптер

| Code  |                 |
|-------|-----------------|
| 46x93 | TE-A01000046-00 |

H- 2100

L- 1330

D-570

## Shelves & Brackets Add-on ONE

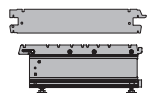
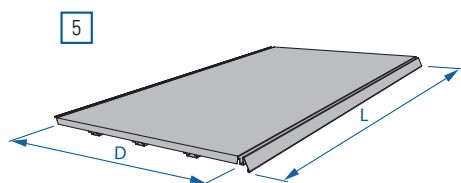

D - 370

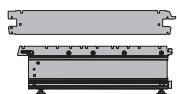

D - 470

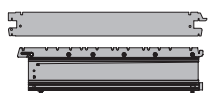

D - 570

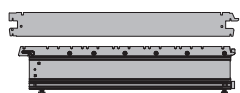

D - 670

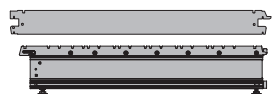

D - 770

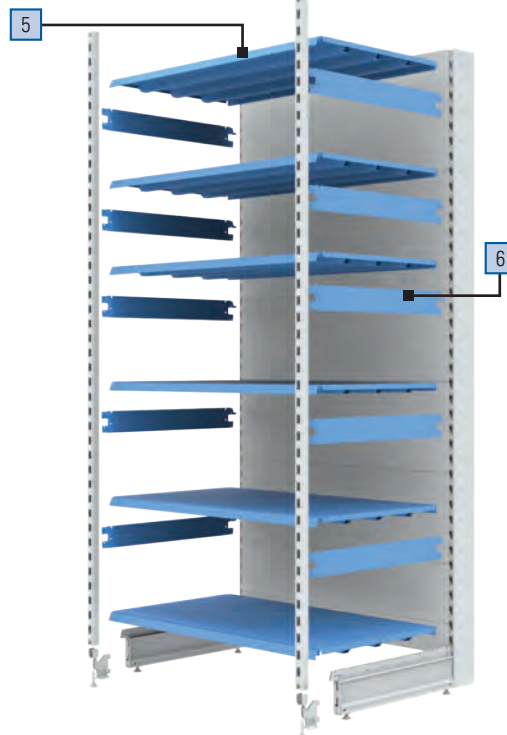

**5 CLASSIC**  
Półka • Shelf • Tablette • Fachboden • Полка

| L   | D   | Reinforcements | Code            |
|-----|-----|----------------|-----------------|
| 600 | 370 | 2              | NE-P00370600-00 |
| 600 | 470 | 2              | NE-P00470600-00 |
| 600 | 570 | 3              | NE-P00570600-00 |
| 600 | 670 | 3              | NE-P00670600-00 |
| 600 | 770 | 4              | NE-P00770600-00 |
| 665 | 370 | 2              | NE-P00370665-00 |
| 665 | 470 | 2              | NE-P00470665-00 |
| 665 | 570 | 3              | NE-P00570665-00 |
| 665 | 670 | 3              | NE-P00670665-00 |
| 665 | 770 | 4              | NE-P00770665-00 |
| 800 | 370 | 2              | NE-P00370800-00 |
| 800 | 470 | 2              | NE-P00470800-00 |
| 800 | 570 | 3              | NE-P00570800-00 |
| 800 | 670 | 3              | NE-P00670800-00 |
| 800 | 770 | 4              | NE-P00770800-00 |

**5 CLASSIC**  
Półka • Shelf • Tablette • Fachboden • Полка

| L    | D   | Reinforcements | Code            |
|------|-----|----------------|-----------------|
| 1000 | 370 | 2              | NE-P00371000-00 |
| 1000 | 470 | 2              | NE-P00471000-00 |
| 1000 | 570 | 3              | NE-P00571000-00 |
| 1000 | 670 | 3              | NE-P00671000-00 |
| 1000 | 770 | 4              | NE-P00771000-00 |
| 1250 | 370 | 2              | NE-P00371250-00 |
| 1250 | 470 | 3              | NE-P00471250-00 |
| 1250 | 570 | 3              | NE-P00571250-00 |
| 1250 | 670 | 3              | NE-P00671250-00 |
| 1250 | 770 | 4              | NE-P00771250-00 |
| 1330 | 370 | 2              | NE-P00371330-00 |
| 1330 | 470 | 3              | NE-P00471330-00 |
| 1330 | 570 | 3              | NE-P00571330-00 |
| 1330 | 670 | 3              | NE-P00671330-00 |
| 1330 | 770 | 4              | NE-P00771330-00 |

**6 SINGLE BEARER** • Wspornik obustronny • Two-sided bracket  
Console bilatérale • Konsole beidseitig • Кронштейн двухсторонний

| D   | Code            |
|-----|-----------------|
| 370 | TE-W04030370-00 |
| 470 | TE-W04030470-00 |
| 570 | TE-W04030570-00 |
| 670 | TE-W04030670-00 |
| 770 | TE-W04030770-00 |





H- 2100

L- 1330

D-570

## Uprights & Base-legs Add-on TWO

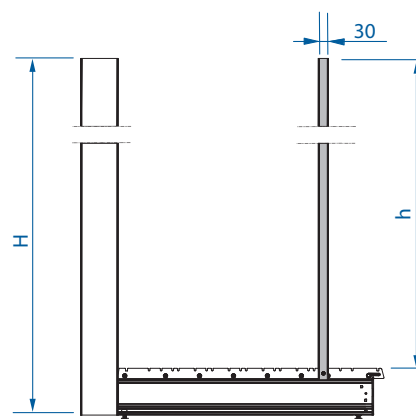
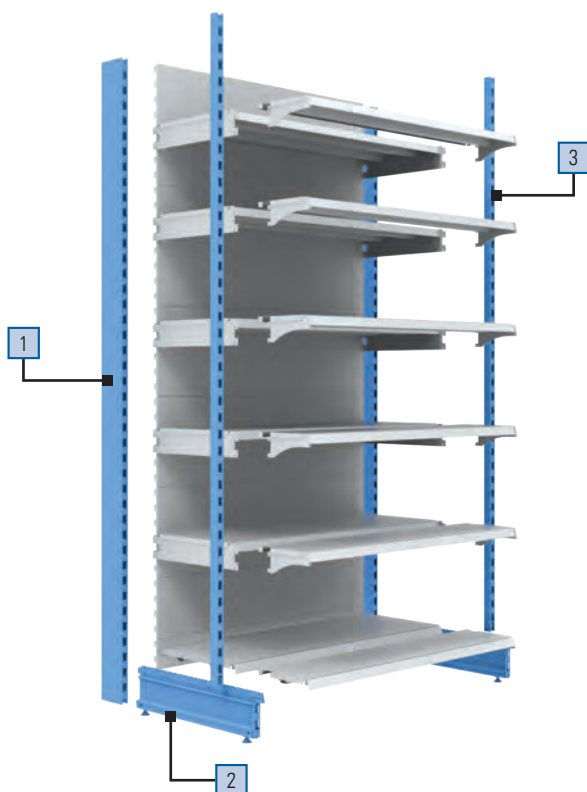

**1 60 × 30**  
 Stup • Add-on upright • Montant • Säule • Профиль

| H    | Code            |
|------|-----------------|
| 1100 | TE-N07006110-00 |
| 1200 | TE-N07006120-00 |
| 1400 | TE-N07006140-00 |
| 1600 | TE-N07006160-00 |
| 1800 | TE-N07006180-00 |
| 2000 | TE-N07006200-00 |
| 2100 | TE-N07006210-00 |
| 2200 | TE-N07006220-00 |
| 2400 | TE-N07006240-00 |
| 2600 | TE-N07006260-00 |
| 2800 | TE-N07006280-00 |
| 3000 | TE-N07006300-00 |

**1 110 × 30**  
 Stup • Add-on upright • Montant • Säule • Профиль

| H    | Code            |
|------|-----------------|
| 1800 | TE-N07011180-00 |
| 2000 | TE-N07011200-00 |
| 2200 | TE-N07011220-00 |
| 2400 | TE-N07011240-00 |

**1 80 × 30**  
 Stup • Add-on upright • Montant • Säule • Профиль

| H    | Code            |
|------|-----------------|
| 1400 | TE-N07008140-00 |
| 1600 | TE-N07008160-00 |
| 1800 | TE-N07008180-00 |
| 2000 | TE-N07008200-00 |
| 2100 | TE-N07008210-00 |
| 2200 | TE-N07008220-00 |
| 2400 | TE-N07008240-00 |
| 2600 | TE-N07008260-00 |
| 2800 | TE-N07008280-00 |
| 3000 | TE-N07008300-00 |

**2 H - 160**  
 Stopa • Baseleg • Pied • Fußteil • Стена

| D   | Code            |
|-----|-----------------|
| 370 | TE-N96337011-00 |
| 470 | TE-N96347011-00 |
| 570 | TE-N96357011-00 |
| 670 | TE-N96367011-00 |
| 770 | TE-N96377011-00 |

**3 FRONT 30 × 30**  
 Stup • Add-on upright • Montant • Säule • Профиль

| H    | h    | Code            |
|------|------|-----------------|
| 1300 | 1200 | TE-N40600120-00 |
| 1400 | 1300 | TE-N40600130-00 |
| 1500 | 1400 | TE-N40600140-00 |
| 1600 | 1500 | TE-N40600150-00 |
| 1700 | 1600 | TE-N40600160-00 |
| 1800 | 1700 | TE-N40600170-00 |
| 1900 | 1800 | TE-N40600180-00 |
| 2000 | 1900 | TE-N40600190-00 |
| 2100 | 2000 | TE-N40600200-00 |
| 2200 | 2100 | TE-N40600210-00 |
| 2300 | 2200 | TE-N40600220-00 |
| 2400 | 2300 | TE-N40600230-00 |
| 2500 | 2400 | TE-N40600240-00 |
| 2600 | 2500 | TE-N40600250-00 |
| 2700 | 2600 | TE-N40600260-00 |
| 3100 | 3000 | TE-N40600300-00 |

H- 2100

L- 1330

D-570

## Shelves & Brackets Add-on TWO

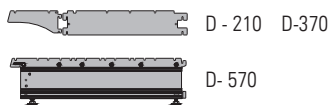
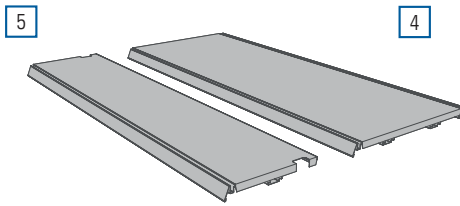

D - 210 D-370

D- 570

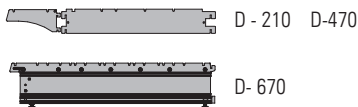

D - 210 D-470

D- 670

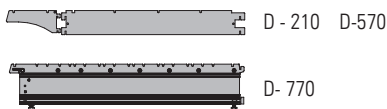

D - 210 D-570

D- 770

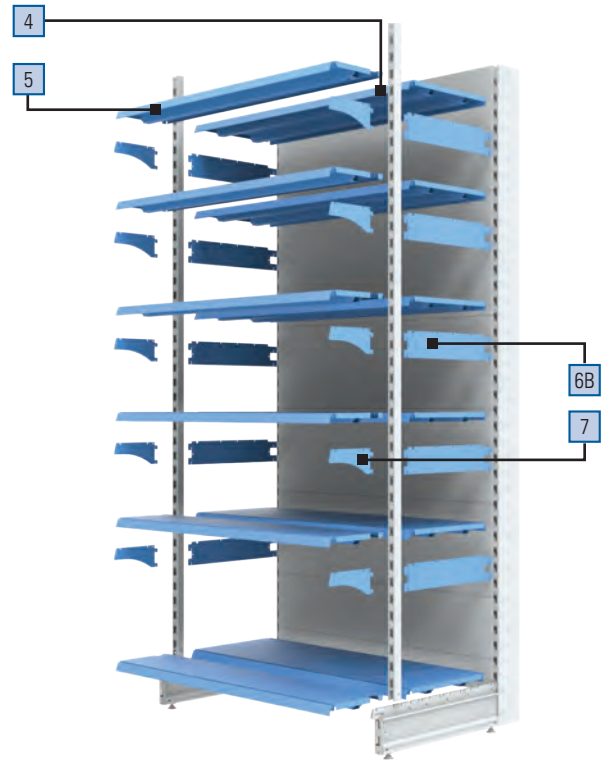

### 4 CLASSIC Półka • Shelf • Tablette • Fachboden • Полка

| L   | D   | Reinforcements | Code            |
|-----|-----|----------------|-----------------|
| 600 | 370 | 2              | NE-P00370600-00 |
| 600 | 470 | 2              | NE-P00470600-00 |
| 600 | 570 | 3              | NE-P00570600-00 |
| 665 | 370 | 2              | NE-P00370665-00 |
| 665 | 470 | 2              | NE-P00470665-00 |
| 665 | 570 | 3              | NE-P00570665-00 |
| 800 | 370 | 2              | NE-P00370800-00 |
| 800 | 470 | 2              | NE-P00470800-00 |
| 800 | 570 | 3              | NE-P00570800-00 |

### 5 ADD-ON • Półka dołączana • Add-on shelf • Tablette avancée • Erweiterungsfachboden • Полка дополнительная

| L    | D   | Code            |
|------|-----|-----------------|
| 600  | 210 | NE-P61210600-00 |
| 665  | 210 | NE-P61210665-00 |
| 800  | 210 | NE-P61210800-00 |
| 1000 | 210 | NE-P61211000-00 |
| 1250 | 210 | NE-P61211250-00 |
| 1330 | 210 | NE-P61211330-00 |

### 4 CLASSIC Półka • Shelf • Tablette • Fachboden • Полка

| L    | D   | Reinforcements | Code            |
|------|-----|----------------|-----------------|
| 1000 | 370 | 2              | NE-P00371000-00 |
| 1000 | 470 | 2              | NE-P00471000-00 |
| 1000 | 570 | 3              | NE-P00571000-00 |
| 1250 | 370 | 2              | NE-P00371250-00 |
| 1250 | 470 | 3              | NE-P00471250-00 |
| 1250 | 570 | 3              | NE-P00571250-00 |
| 1330 | 370 | 2              | NE-P00371330-00 |
| 1330 | 470 | 3              | NE-P00471330-00 |
| 1330 | 570 | 3              | NE-P00571330-00 |

### 7 ADD-ON • Wspornik • Add-on bracket Console avancée • Erweiterungskonsole • Кронштейн

| L   | D | Code            |
|-----|---|-----------------|
| 210 |   | CE-W10290150-00 |

### 6B SINGLE BEARER • Wspornik obustronny • Two-sided bracket Console bilatérale • Konsole beidseitig • Кронштейн двухсторон.

| D   | Code            |
|-----|-----------------|
| 370 | ME-W00430390-00 |
| 470 | ME-W00430470-00 |
| 570 | ME-W00430570-00 |

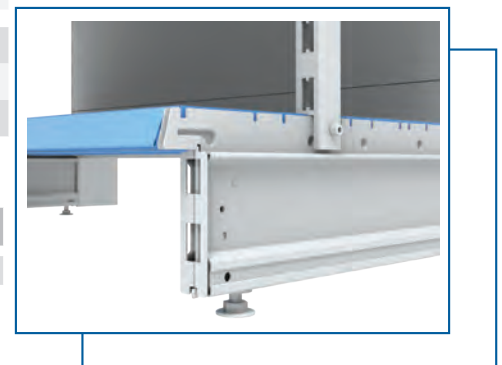

H- 1700    L- 1000    D-570    (End cap)

## End-Caps Back panels, Shelves & Plinths

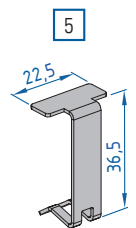
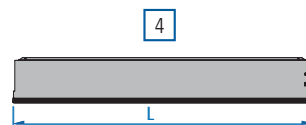
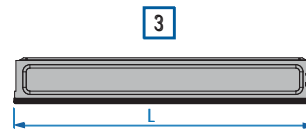
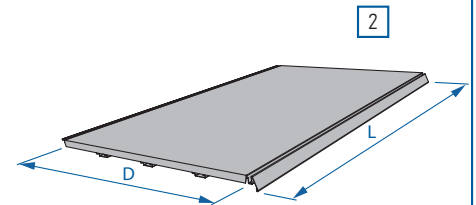

### 1 PLAIN

 Tyły • Back panels • Fonds • Rückwände • Задние стенки

| L    | H   | Code             |
|------|-----|------------------|
| 600  | 200 | TE-T20200600-00  |
| 600  | 300 | TE-T20300600-00  |
| 600  | 400 | TE-T20400600-00  |
| 800  | 200 | TE-T20200800-00  |
| 800  | 300 | TE-T20300800-00  |
| 800  | 400 | TE-T20400800-00  |
| 1000 | 200 | TE-T20201000-00  |
| 1000 | 300 | TE-T20301000-00  |
| 1000 | 400 | TE-T20401000-00  |
| 1200 | 200 | TE-T20201200-00* |
| 1200 | 300 | TE-T20301200-00* |
| 1200 | 400 | TE-T20401200-00* |

### 2 CLASSIC

 Półka • Shelf • Tablette • Fachboden • Полка

| L    | D1  | D2  | Codez           |
|------|-----|-----|-----------------|
| 600  | 370 | 270 | NE-P00370600-00 |
| 600  | 470 | 270 | NE-P00470600-00 |
| 600  | 570 | 270 | NE-P00570600-00 |
| 800  | 370 | 370 | NE-P00370800-00 |
| 800  | 470 | 370 | NE-P00470800-00 |
| 800  | 570 | 370 | NE-P00570800-00 |
| 1000 | 370 | 470 | NE-P00371000-00 |
| 1000 | 470 | 470 | NE-P00471000-00 |
| 1000 | 570 | 470 | NE-P00571000-00 |
| 1200 | 370 | 570 | NE-P00371200-00 |
| 1200 | 470 | 570 | NE-P00471200-00 |
| 1200 | 570 | 570 | NE-P00571200-00 |

### 3 DE

 Oslona dolna • Plinth • Plinthe • Sockelblende • Плинтус

| L    | Code            |
|------|-----------------|
| 600  | OS-D71150600-00 |
| 665  | OS-D71150665-00 |
| 800  | OS-D71150800-00 |
| 1000 | OS-D71151000-00 |
| 1250 | OS-D71151250-00 |
| 1330 | OS-D71151330-00 |

### 5 P50

 Zabezpieczenie • Safety lock  
 Antidécrochement de fond • Sicherung • Фиксатор

| Code            |
|-----------------|
| ME-A05070050-50 |

### 4 UK

 Oslona dolna • Plinth • Plinthe • Sockelblende • Плинтус

| L    | Code            |
|------|-----------------|
| 600  | OS-D73150600-00 |
| 665  | OS-D73150665-00 |
| 800  | OS-D73150800-00 |
| 1000 | OS-D73151000-00 |
| 1200 | OS-D73151200-00 |
| 1250 | OS-D73151250-00 |
| 1330 | OS-D73151330-00 |

## End-Caps Uprights, Connectors, Tie Bars & Accessories

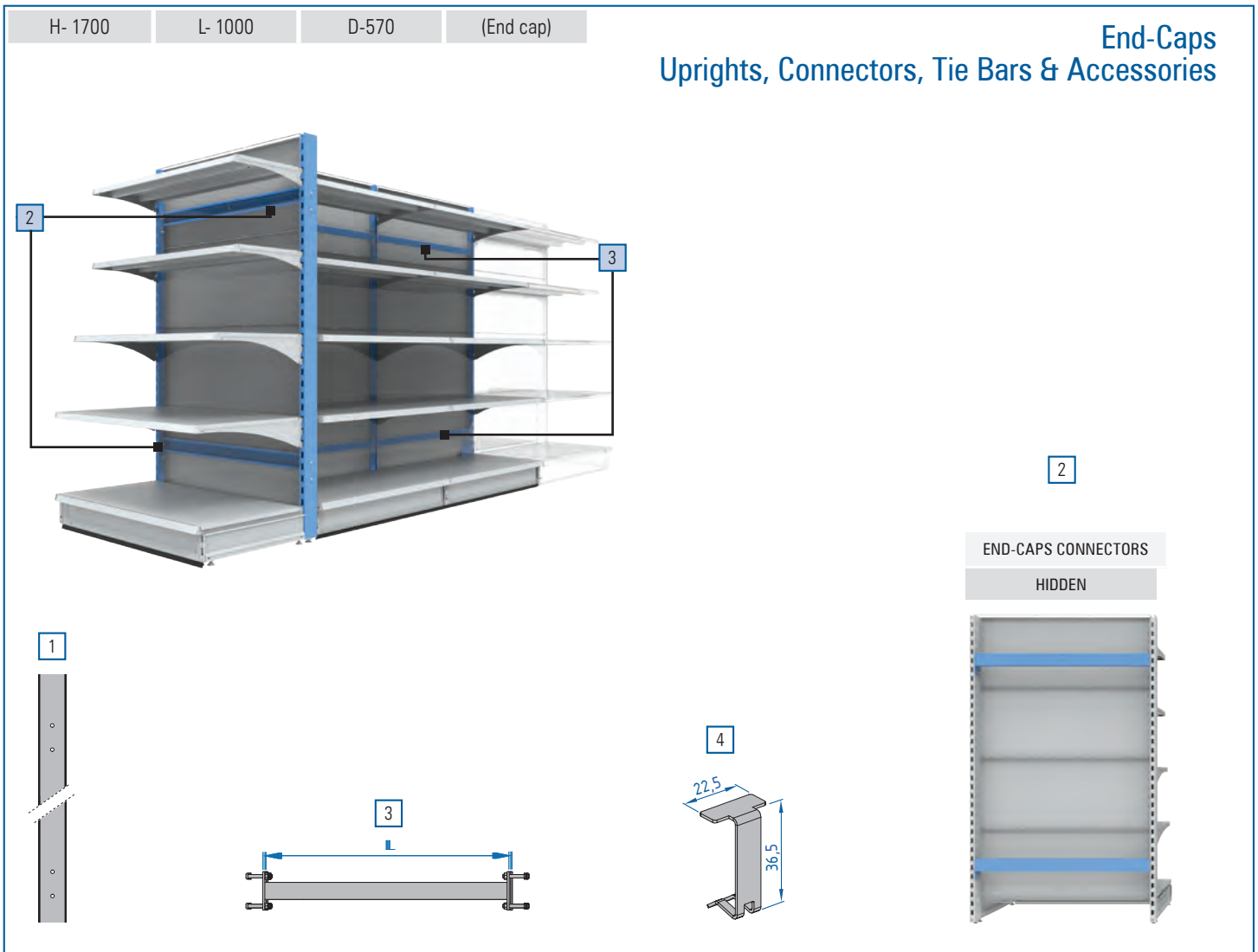

**1 60 × 30 DRILLED**  
Slup • Add-on upright • Montant • Säule • Профиль

| H    | Code            |
|------|-----------------|
| 1100 | TE-N17006110-00 |
| 1200 | TE-N17006120-00 |
| 1400 | TE-N17006140-00 |
| 1600 | TE-N17006160-00 |
| 1800 | TE-N17006180-00 |
| 2000 | TE-N17006200-00 |
| 2100 | TE-N17006210-00 |
| 2200 | TE-N17006220-00 |

**1 80 × 30 DRILLED**  
Slup • Add-on upright • Montant • Säule • Профиль

| H    | Code            |
|------|-----------------|
| 1400 | TE-N17008140-00 |
| 1600 | TE-N17008160-00 |
| 1800 | TE-N17008180-00 |
| 2000 | TE-N17008200-00 |
| 2100 | TE-N17008210-00 |
| 2200 | TE-N17008220-00 |

**2 CONNECTOR HIDDEN**  
Łącznik dostawki • End-Cap Connector • Barre de fixation TG  
Verbindung für Kopffregal • Соединитель торца

| L    | Code            |
|------|-----------------|
| 600  | TE-B01020600-00 |
| 800  | TE-B01020800-00 |
| 1000 | TE-B01021000-00 |
| 1200 | TE-B01021200-00 |

**3 TIE BAR (required gondola reinforcement)** • Belka  
Bar • Barre de renfort • Verstärkung • Балка усиления

| L    | Code            |
|------|-----------------|
| 600  | TE-B00020600-00 |
| 665  | TE-B00020665-00 |
| 800  | TE-B00020800-00 |
| 1000 | TE-B00021000-00 |
| 1250 | TE-B00021250-00 |
| 1330 | TE-B00021330-00 |

**4 P50** • Zabezpieczenie • Safety lock •  
Antidécrochement de fond • Sicherung • Фиксатор

| Code            |
|-----------------|
| ME-A05070050-50 |

Аксессуары  
Accessories  
Zubehör  
Акcesoria  
Accessoires





H- 2100

L- 1000

D-570

## Accessories

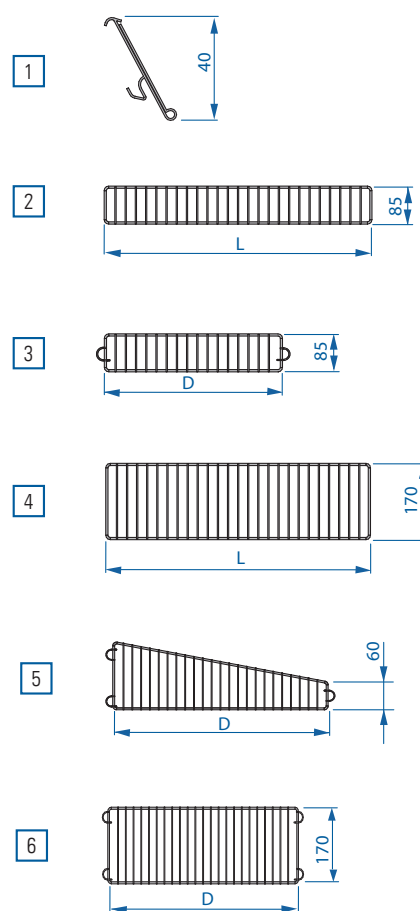
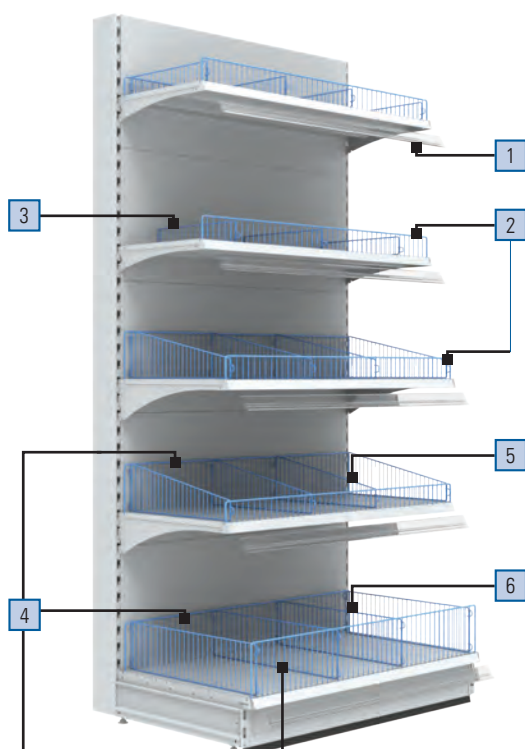

**1 CLEAR** • Listwa cenowa • Price strip  
 Porte-étiquette • Preisschiene • Ценникодержатель

| D    | Code            |
|------|-----------------|
| 600  | ME-C00100600-89 |
| 665  | ME-C00100665-89 |
| 800  | ME-C00100800-89 |
| 1000 | ME-C00101000-89 |
| 1250 | ME-C00101250-89 |
| 1330 | ME-C00101330-89 |

**2 WIRE H-85** • Listwa druciana • Wire strip  
 Latte fil • Frontgitter • Ограждение сетчатое

| L    | Code            |
|------|-----------------|
| 600  | ME-L00010600-00 |
| 665  | ME-L00010665-00 |
| 800  | ME-L00010800-00 |
| 1000 | ME-L00011000-00 |
| 1250 | ME-L00011250-00 |
| 1330 | ME-L00011330-00 |

**3 WIRE H-85** • Przegroda • Divider  
 Séparateur • Trenngitter • Перегородка

| D   | Code            |
|-----|-----------------|
| 370 | ME-D00010370-00 |
| 470 | ME-D00010470-00 |
| 570 | ME-D00010570-00 |

**4 WIRE H-170** • Listwa druciana • Wire strip  
 Latte fil • Frontgitter • Ограждение сетчатое

| L    | Code            |
|------|-----------------|
| 600  | ME-L00050600-00 |
| 665  | ME-L00050665-00 |
| 800  | ME-L00050800-00 |
| 1000 | ME-L00051000-00 |
| 1250 | ME-L00051250-00 |
| 1330 | ME-L00051330-00 |

**5 WIRE H-170** • Przegroda • Divider  
 Séparateur • Trenngitter • Перегородка

| D   | Code            |
|-----|-----------------|
| 370 | ME-D00100370-00 |
| 470 | ME-D00100470-00 |
| 570 | ME-D00100570-00 |

**6 WIRE H-170** • Przegroda h-170 • Divider  
 Séparateur • Trenngitter • Перегородка

| D   | Code            |
|-----|-----------------|
| 370 | ME-D00040370-00 |
| 470 | ME-D00040470-00 |
| 570 | ME-D00040570-00 |



H- 2100

L- 1000

D-570

**Accessories**

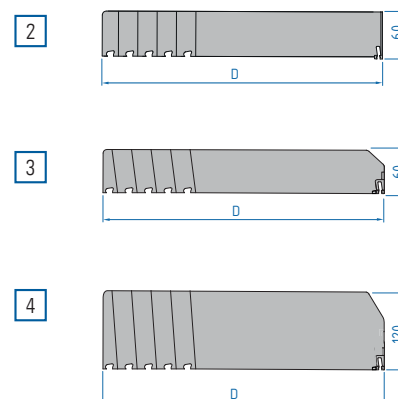
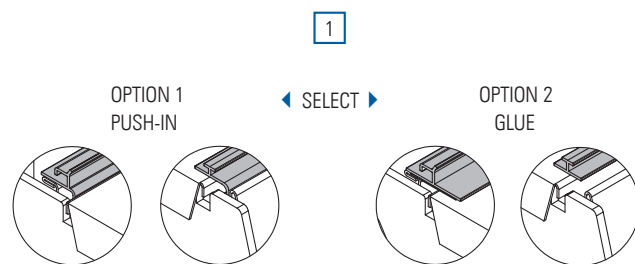
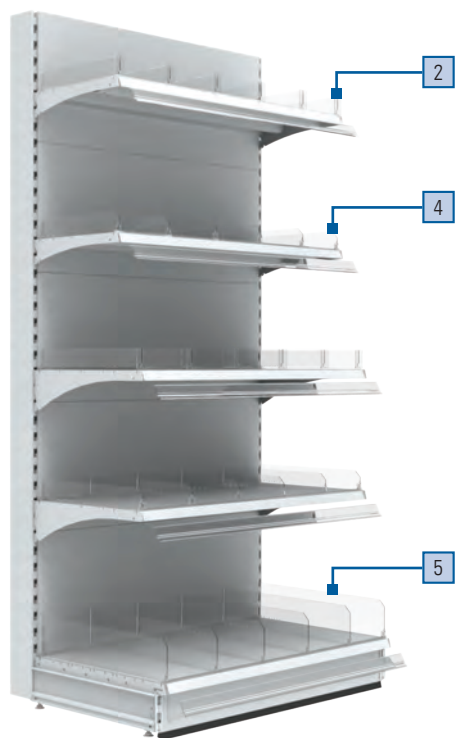

**1 PUSH IN**  
Listwa • Slat • Latte • Leiste • Планка

| L    | Rear            | Front           |
|------|-----------------|-----------------|
| 1000 | ME-L01071000-89 | ME-L01061000-89 |
| 1250 | ME-L01071250-89 | ME-L01061250-89 |
| 1330 | ME-L01071330-89 | ME-L01061330-89 |

**1 GLUE**  
Listwa • Slat • Latte • Leiste • Планка

| L    | Rear            | tt              |
|------|-----------------|-----------------|
| 1000 | ME-L01081000-89 | ME-L01091000-89 |
| 1250 | ME-L01081250-89 | ME-L01091250-89 |
| 1330 | ME-L01081330-89 | ME-L01091330-89 |

**2 H-60 CLEAR** • Przegroda T  
Divider T • Séparateur T • Trenngitter T • Перегородка T

| D   | Code            |
|-----|-----------------|
| 270 | ME-D01050270-89 |
| 370 | ME-D01050370-89 |
| 470 | ME-D01050470-89 |
| 570 | ME-D01050570-89 |

**3 H-60 CLEAR**  
Przegroda • Divider • Séparateur • Trenngitter • Перегородка

| D   | Code            |
|-----|-----------------|
| 270 | ME-D01020270-89 |
| 370 | ME-D01020370-89 |
| 470 | ME-D01020470-89 |
| 570 | ME-D01020570-89 |

**4 H-120 CLEAR**  
Przegroda • Divider • Séparateur • Trenngitter • Перегородка

| D   | Code            |
|-----|-----------------|
| 370 | ME-D01080370-89 |
| 470 | ME-D01080470-89 |
| 570 | ME-D01080570-89 |



H- 2100

L- 1000

D-570

## Wire Baskets

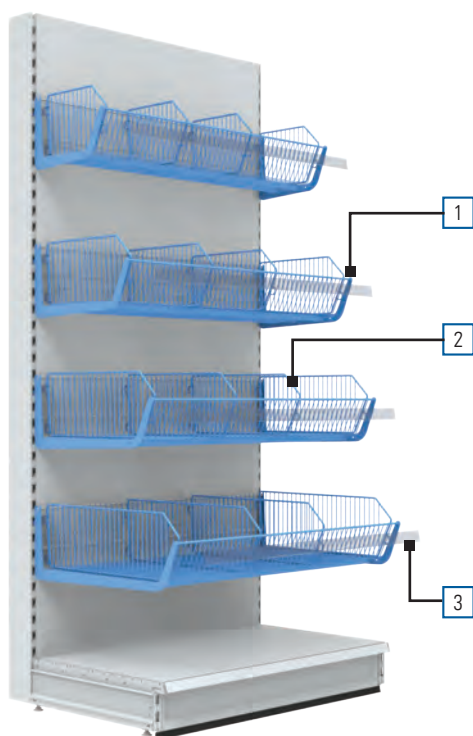

1

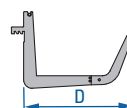

2

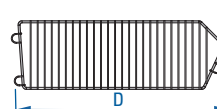
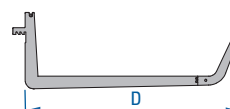
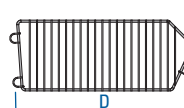
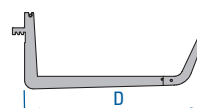
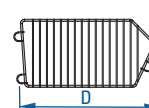
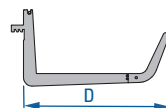
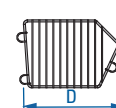

3



1

Kosz • Basket  
Panier suspendu • Einhängkorb • Корзина

| L   | D   | Code            |
|-----|-----|-----------------|
| 600 | 270 | ME-K68270600-00 |
| 600 | 370 | ME-K68370600-00 |
| 600 | 470 | ME-K68470600-00 |
| 600 | 570 | ME-K68570600-00 |
| 665 | 270 | ME-K68270665-00 |
| 665 | 370 | ME-K68370665-00 |
| 665 | 470 | ME-K68470665-00 |
| 665 | 570 | ME-K68570665-00 |
| 800 | 270 | ME-K68270800-00 |
| 800 | 370 | ME-K68370800-00 |
| 800 | 470 | ME-K68470800-00 |
| 800 | 570 | ME-K68570800-00 |

1

Kosz • Basket  
Panier suspendu • Einhängkorb • Корзина

| L    | D   | Code            |
|------|-----|-----------------|
| 1000 | 270 | ME-K68271000-00 |
| 1000 | 370 | ME-K68371000-00 |
| 1000 | 470 | ME-K68471000-00 |
| 1000 | 570 | ME-K68571000-00 |
| 1250 | 270 | ME-K68271250-00 |
| 1250 | 370 | ME-K68371250-00 |
| 1250 | 470 | ME-K68471250-00 |
| 1250 | 570 | ME-K68571250-00 |
| 1330 | 270 | ME-K68271330-00 |
| 1330 | 370 | ME-K68371330-00 |
| 1330 | 470 | ME-K68471330-00 |
| 1330 | 570 | ME-K68571330-00 |

2

Przegroda •  
Divider • Séparateur • Trenngitter • Перегородка

| D   | Code            |
|-----|-----------------|
| 270 | ME-D00290270-00 |
| 370 | ME-D00290370-00 |
| 470 | ME-D00290470-00 |
| 570 | ME-D00290570-00 |

3

Listwa cenowa • Price strip  
Porte-étiquette • Preisschiene • Ценникодержатель

| L    | Code            |
|------|-----------------|
| 600  | ME-C00300600-89 |
| 665  | ME-C00300665-89 |
| 800  | ME-C00300800-89 |
| 1000 | ME-C00300990-89 |
| 1250 | ME-C00301240-89 |
| 1330 | ME-C00301320-89 |

H- 2100

L- 1000

D-570

## Wire Baskets



**1** PÓŁKA DRUCIANA • Wire shelf • Tablette fil  
Gitterboden • Полка сетчатая

| L   | D   | Code            |
|-----|-----|-----------------|
| 665 | 370 | MM-D06370665-00 |
| 665 | 470 | MM-D06470665-00 |
| 665 | 570 | MM-D06570665-00 |

**1** PÓŁKA DRUCIANA • Wire shelf • Tablette fil  
Gitterboden • Полка сетчатая

| L    | D   | Code            |
|------|-----|-----------------|
| 1000 | 370 | MM-D06371000-00 |
| 1000 | 470 | MM-D06471000-00 |
| 1000 | 570 | MM-D06571000-00 |

**1** PÓŁKA DRUCIANA • Wire shelf • Tablette fil  
Gitterboden • Полка сетчатая

| L    | D   | Code            |
|------|-----|-----------------|
| 1250 | 370 | MM-D06371250-00 |
| 1250 | 470 | MM-D06471250-00 |
| 1250 | 570 | MM-D06571250-00 |

**1** PÓŁKA DRUCIANA • Wire shelf • Tablette fil  
Gitterboden • Полка сетчатая

| L    | D   | Code            |
|------|-----|-----------------|
| 1330 | 370 | MM-D06371330-00 |
| 1330 | 470 | MM-D06471330-00 |
| 1330 | 570 | MM-D06571330-00 |

**2** Listwa cenowa • Price strip  
Porte-étiquette • Preisschiene • Ценникодержатель

| L   | Code            |
|-----|-----------------|
| 250 | ME-C00300250-89 |

H- 2100

L- 1000

D-570

## Bars &amp; Hooks

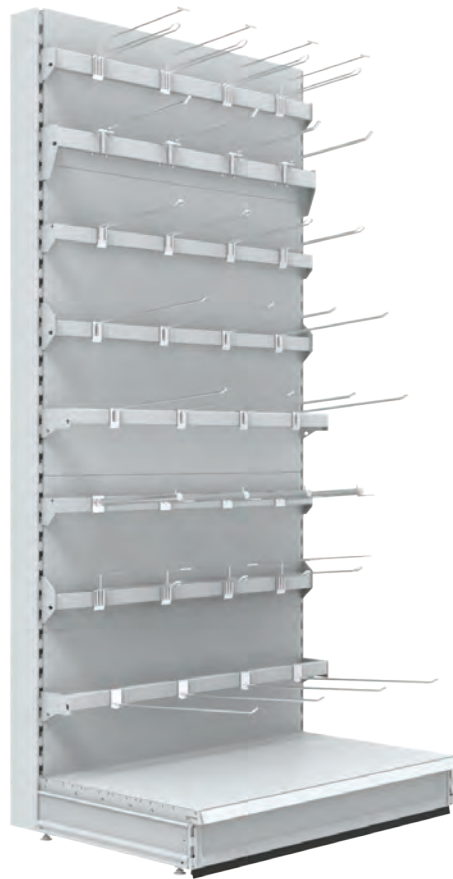

H- 2100

L- 1000 (3x)

D-570



## Bars & Hooks

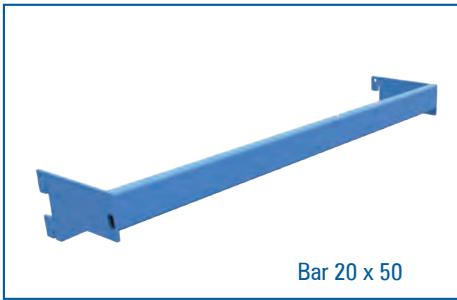

**1** Belka • Bar • Barre • Trageschiene • Балка

| L    | Code            |
|------|-----------------|
| 665  | ME-B00640665-00 |
| 1000 | ME-B00641000-00 |
| 1250 | ME-B00641250-00 |
| 1330 | ME-B00641330-00 |



**2** Wieszak • Hook • Broche • Halter • Крючок

| ∅ | D   | Code            |
|---|-----|-----------------|
| 6 | 300 | WB-A38206300-00 |
| 6 | 400 | WB-A38206400-00 |
| 8 | 300 | WB-A38208300-00 |
| 8 | 400 | WB-A38208400-00 |

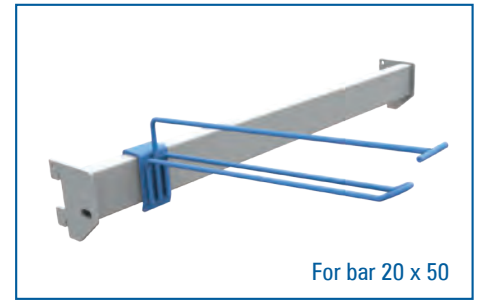

**3** Wieszak • Hook • Broche • Halter • Крючок

| ∅ | D   | Code            |
|---|-----|-----------------|
| 6 | 400 | WB-A65706400-00 |

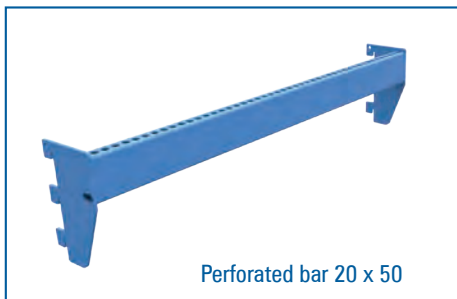

**4** Belka Perforowana • Bar Perforated  
Barre Perforée • Trageschiene Gelocht • Балка Перфориров.

| L    | Code            |
|------|-----------------|
| 665  | ME-B02150665-00 |
| 1000 | ME-B02151000-00 |
| 1250 | ME-B02151250-00 |
| 1330 | ME-B02151330-00 |

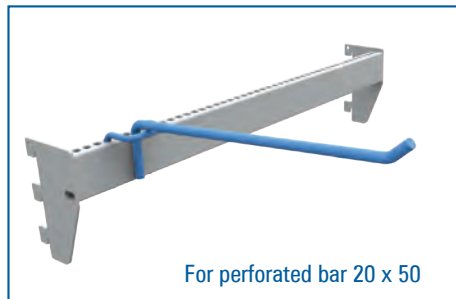

**5** Wieszak • Hook • Broche • Halter • Крючок

| ∅  | D   | Code            |
|----|-----|-----------------|
| 10 | 200 | WB-P03510200-00 |
| 10 | 300 | WB-P03510300-00 |
| 10 | 400 | WB-P03510400-00 |

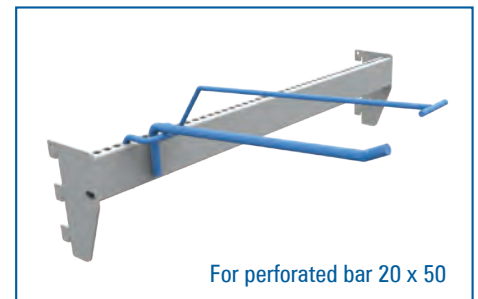

**6** Wieszak • Hook • Broche • Halter • Крючок

| ∅  | D   | Code            |
|----|-----|-----------------|
| 6  | 400 | WB-P03606400-00 |
| 10 | 200 | WB-P03610200-00 |
| 10 | 300 | WB-P03610300-00 |
| 10 | 400 | WB-P03610400-00 |

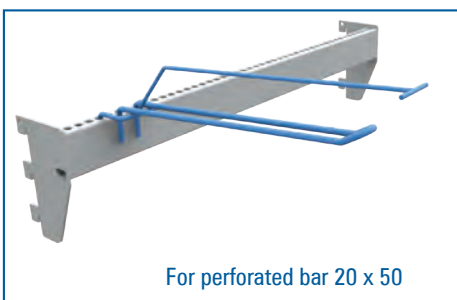

**7** Wieszak • Hook • Broche • Halter • Крючок

| ∅  | D   | Code            |
|----|-----|-----------------|
| 6  | 200 | WB-P00906200-00 |
| 6  | 400 | WB-P00906400-00 |
| 10 | 300 | WB-P00910300-00 |
| 10 | 400 | WB-P00910400-00 |

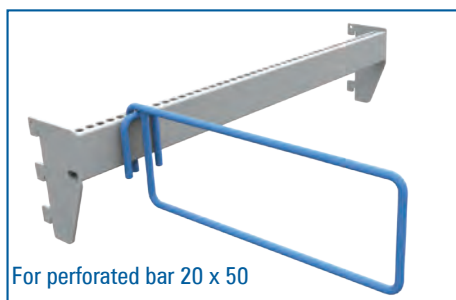

**2d** Wieszak • Hook • Broche • Halter • Крючок

| D   | Code            |
|-----|-----------------|
| 200 | WB-P06208200-00 |
| 300 | WB-P06208300-00 |
| 400 | WB-P06208400-00 |

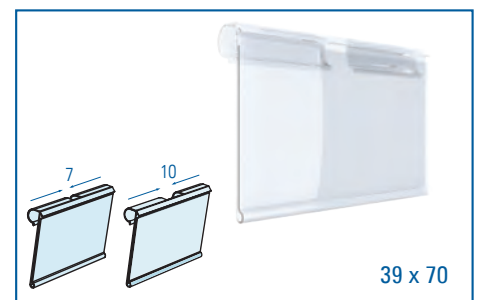

Etykieta wahlwa przezroczysta • Clear swing ticket • Porte-étiquette en PVC Transparent • Etikettentasche transparent  
Ценникодержатель навесной (прозрачный)

| ∅         | Code         |
|-----------|--------------|
| 5 / 6 / 7 | WA-E00000101 |
| 8 / 10    | WA-E00000108 |

## Bars & Hooks

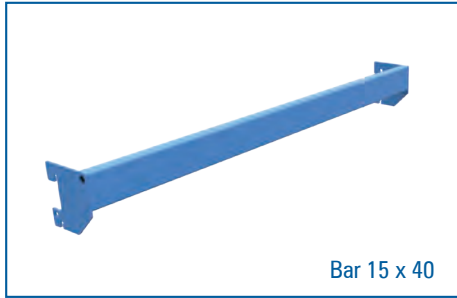

1 Belka • Bar • Barre • Trageschiene • Балка

| L    | Code            |
|------|-----------------|
| 665  | ME-B00050665-00 |
| 1000 | ME-B00051000-00 |
| 1250 | ME-B00051250-00 |
| 1330 | ME-B00051330-00 |

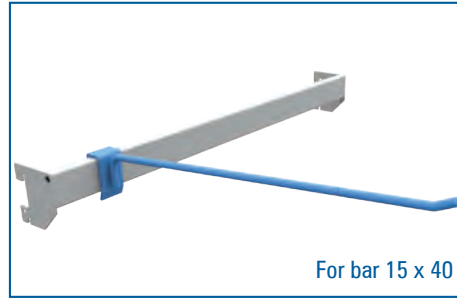

2 Wieszak • Hook • Broche • Halter • Крючок

| ∅ | D   | Code            |
|---|-----|-----------------|
| 6 | 200 | WB-A36406200-00 |
| 6 | 300 | WB-A36406300-00 |
| 6 | 400 | WB-A36406400-00 |

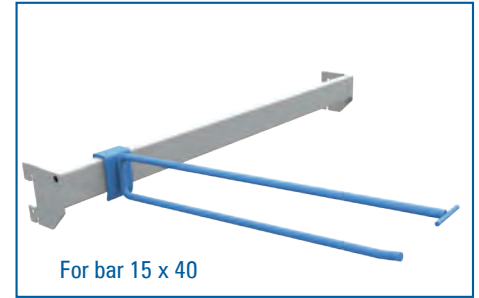

3 Wieszak • Hook • Broche • Halter • Крючок

| ∅ | D   | Code            |
|---|-----|-----------------|
| 6 | 200 | WB-A36806200-00 |
| 6 | 300 | WB-A36806300-00 |
| 8 | 400 | WB-A36808400-00 |
| 8 | 500 | WB-A36808500-00 |

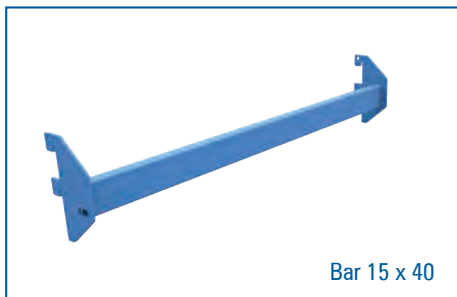

4 Belka • Bar • Barre • Trageschiene • Балка

| L    | Code            |
|------|-----------------|
| 665  | ME-B00570665-00 |
| 1000 | ME-B00571000-00 |
| 1250 | ME-B00571250-00 |
| 1330 | ME-B00571330-00 |

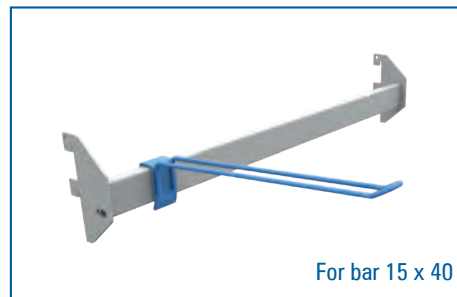

5 Wieszak • Hook • Broche • Halter • Крючок

| ∅ | D   | Code            |
|---|-----|-----------------|
| 5 | 100 | WB-A38805100-00 |
| 5 | 200 | WB-A38805200-00 |
| 5 | 300 | WB-A38805300-00 |

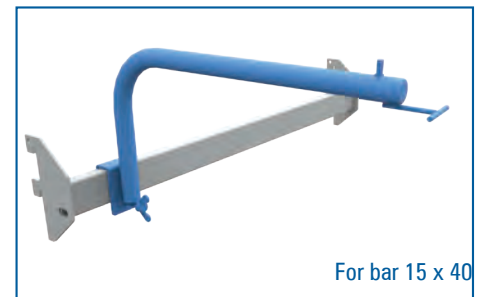

6 Wieszak • Hook • Broche • Halter • Крючок

| ∅  | D   | Code            |
|----|-----|-----------------|
| 20 | 300 | WB-A07120300-00 |
| 20 | 400 | WB-A07120400-00 |
| 20 | 500 | WB-A07120500-00 |

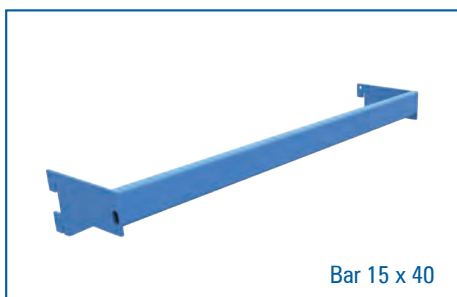

7 Belka • Bar • Barre • Trageschiene • Балка

| L    | Code            |
|------|-----------------|
| 665  | ME-B00660665-00 |
| 1000 | ME-B00661000-00 |
| 1250 | ME-B00661250-00 |
| 1330 | ME-B00661330-00 |

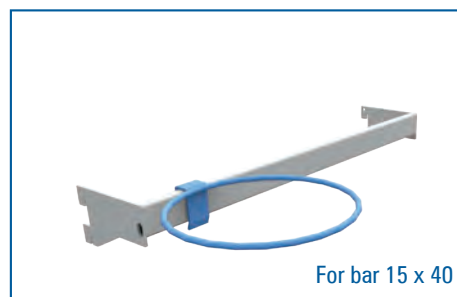

8 Belka • Bar • Barre • Trageschiene • Балка

| Diameter | D   | Code            |
|----------|-----|-----------------|
| 210      | 215 | WB-A79607215-00 |

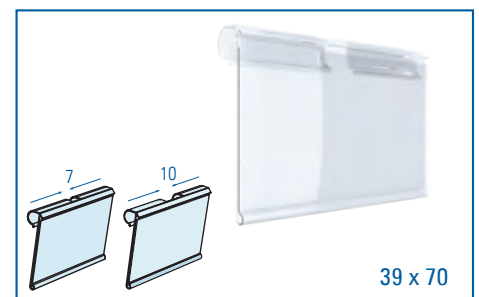

8 Etykieta wahliva przezroczysta • Clear swing ticket • Porte-étiquette en PVC Transparent • Etikettentasche transparent • Ценникодержатель навесной (прозрачный)

| ∅         | Code         |
|-----------|--------------|
| 5 / 6 / 7 | WA-E00000101 |
| 8 / 10    | WA-E00000108 |

## Bars & Hooks

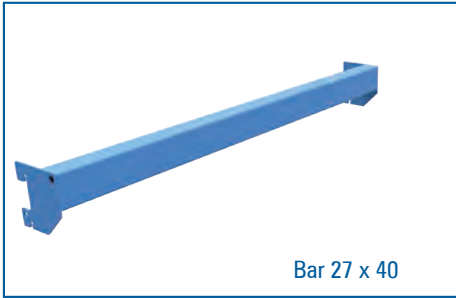

**1** Belka • Bar • Barre • Trageschiene • Балка

| L    | Code            |
|------|-----------------|
| 665  | ME-B00010665-00 |
| 1000 | ME-B00011000-00 |
| 1250 | ME-B00011250-00 |
| 1330 | ME-B00011330-00 |

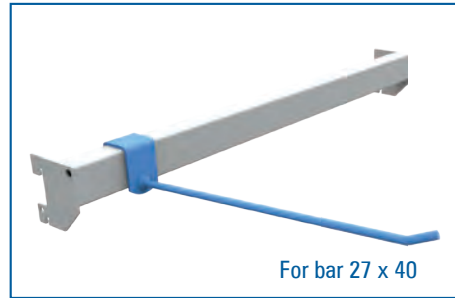

**2** Wieszak • Hook • Broche • Halter • Крючок

| ∅ | D   | Code            |
|---|-----|-----------------|
| 6 | 200 | WB-A02106200-00 |
| 6 | 300 | WB-A02106300-00 |
| 8 | 400 | WB-A02108400-00 |
| 8 | 500 | WB-A02108500-00 |

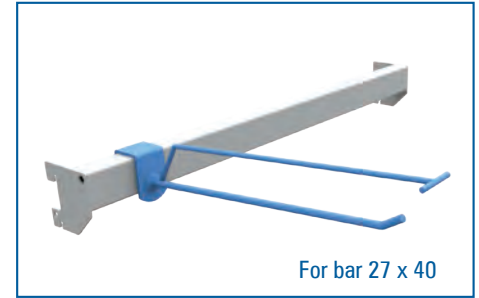

**3** Wieszak • Hook • Broche • Halter • Крючок

| ∅ | D   | Code            |
|---|-----|-----------------|
| 6 | 200 | WB-A02406200-00 |
| 6 | 300 | WB-A02406300-00 |
| 8 | 400 | WB-A02408400-00 |
| 8 | 500 | WB-A02408500-00 |

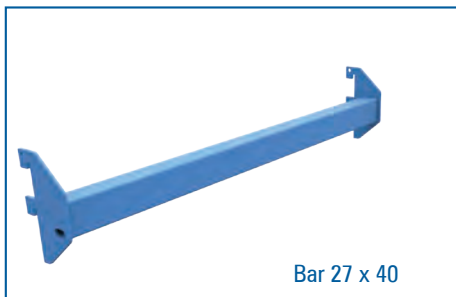

**4** Belka • Bar • Barre • Trageschiene • Балка

| L    | Code            |
|------|-----------------|
| 665  | ME-B00590665-00 |
| 1000 | ME-B00591000-00 |
| 1250 | ME-B00591250-00 |
| 1330 | ME-B00591330-00 |

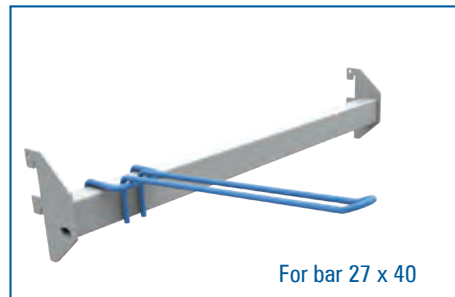

**5** Wieszak • Hook • Broche • Halter • Крючок

| ∅ | D   | Code            |
|---|-----|-----------------|
| 5 | 200 | WB-A00205200-00 |

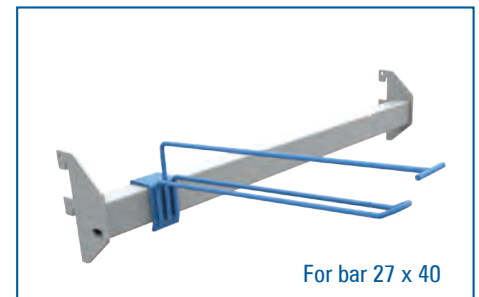

**6** Wieszak • Hook • Broche • Halter • Крючок

| ∅ | D   | Code            |
|---|-----|-----------------|
| 6 | 300 | WB-A00706300-00 |
| 6 | 400 | WB-A00706400-00 |
| 8 | 450 | WB-A00708450-00 |

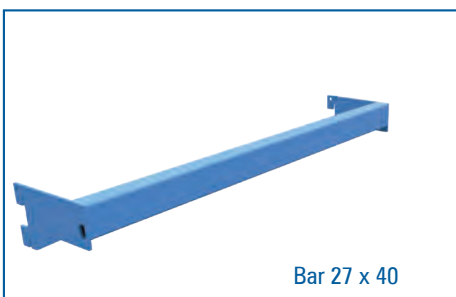

**7** 27 x 40 • Belka  
Bar • Barre • Trageschiene • Балка

| L    | Code-           |
|------|-----------------|
| 665  | ME-B00710665-00 |
| 1000 | ME-B00711000-00 |
| 1250 | ME-B00711250-00 |
| 1330 | ME-B00711330-00 |

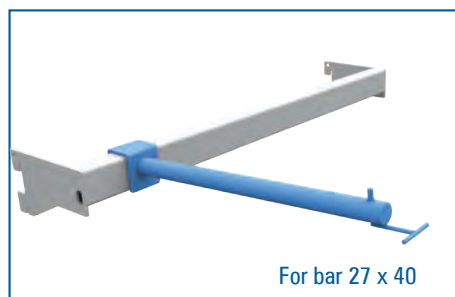

**8** Wieszak • Hook • Broche • Halter • Крючок

| ∅  | D   | Code            |
|----|-----|-----------------|
| 20 | 350 | WB-A06620350-00 |
| 20 | 500 | WB-A06620500-00 |

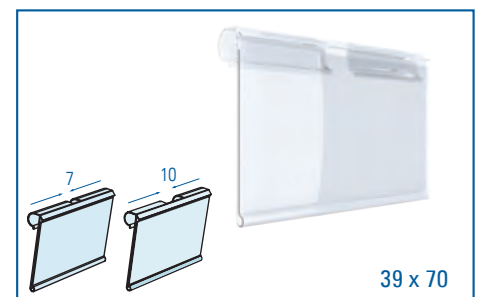

Etykieta wahlwa przezroczysta • Clear swing ticket • Porte-étiquette en PVC Transparent • Etikettentasche transparent  
Ценникодержатель навесной (прозрачный)

| ∅         | Code         |
|-----------|--------------|
| 5 / 6 / 7 | WA-E00000101 |
| 8 / 10    | WA-E00000108 |

H- 1700

L- 1000

D-570

## Hooks (For EURO Perforated Back panels)

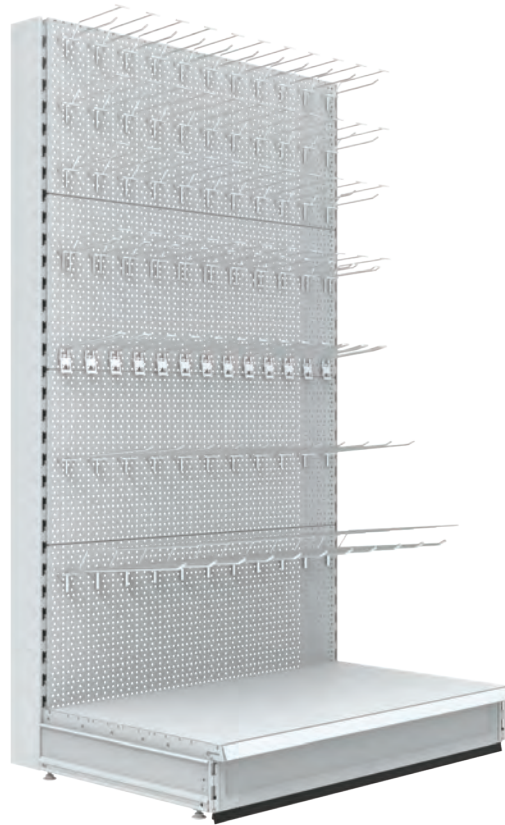

H- 1700

L- 1000 (3x)

D-570



## Hooks

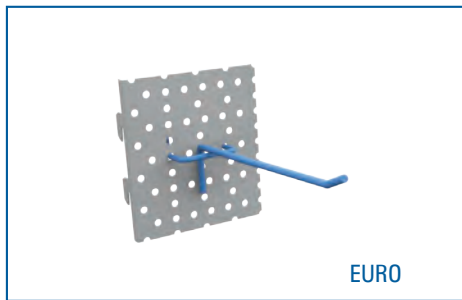

EURO

1 Wieszak • Hook • Broche • Halter • Крючок

| ∅ | D   | Code            |
|---|-----|-----------------|
| 4 | 120 | EM-P56040120-00 |
| 4 | 180 | EM-P56040180-00 |
| 5 | 200 | WT-N00105200-00 |
| 5 | 300 | WT-N00105300-00 |
| 6 | 300 | WT-N00106300-00 |
| 6 | 400 | WT-N00106400-00 |

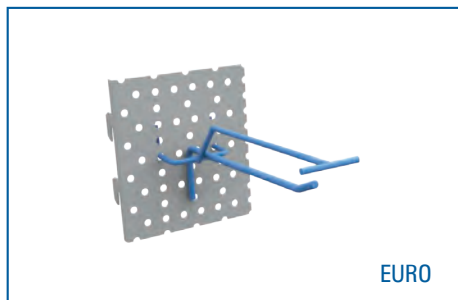

EURO

2 Wieszak • Hook • Broche • Halter • Крючок

| ∅ | D   | Code            |
|---|-----|-----------------|
| 5 | 140 | EM-P56150140-00 |
| 5 | 180 | EM-P56150180-00 |

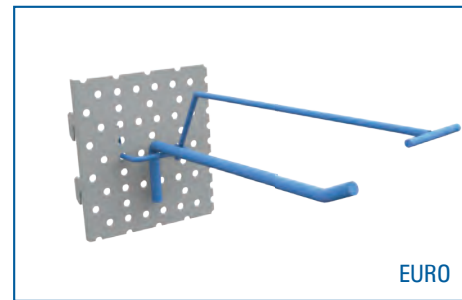

EURO

3 Wieszak • Hook • Broche • Halter • Крючок

| ∅ | D   | Code            |
|---|-----|-----------------|
| 6 | 200 | WT-N00906200-00 |
| 6 | 300 | WT-N00906300-00 |
| 8 | 300 | WT-N00908300-00 |
| 8 | 400 | WT-N00908400-00 |

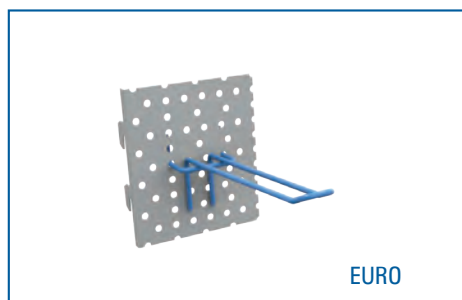

EURO

4 Wieszak • Hook • Broche • Halter • Крючок

| ∅ | D   | Code            |
|---|-----|-----------------|
| 4 | 120 | EM-P57040120-00 |
| 4 | 180 | EM-P57040180-00 |
| 5 | 100 | WT-N00205100-00 |
| 5 | 150 | WT-N00205150-00 |
| 5 | 200 | WT-N00205200-00 |
| 5 | 300 | WT-N00205300-00 |

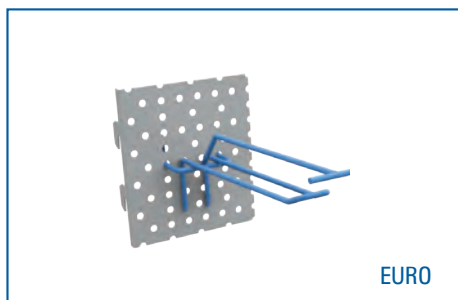

EURO

5 Wieszak • Hook • Broche • Halter • Крючок

| ∅ | D   | Code            |
|---|-----|-----------------|
| 4 | 140 | EM-P57140140-00 |
| 4 | 180 | EM-P57140180-00 |

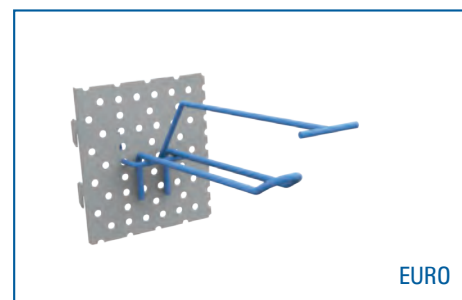

EURO

6 Wieszak • Hook • Broche • Halter • Крючок

| ∅ | D   | Code            |
|---|-----|-----------------|
| 5 | 200 | WT-N02005200-00 |
| 5 | 300 | WT-N02005300-00 |

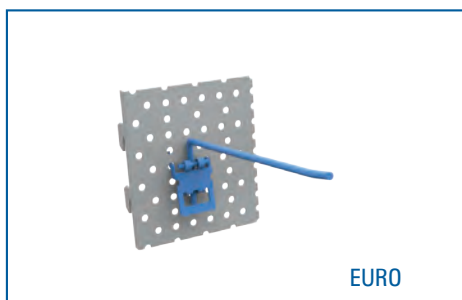

EURO

7 Wieszak • Hook • Broche • Halter • Крючок

| ∅ | D   | Code            |
|---|-----|-----------------|
| 5 | 150 | WT-N21405150-00 |
| 5 | 200 | WT-N21405200-00 |
| 5 | 300 | WT-N21405300-00 |
| 5 | 400 | WT-N21405400-00 |

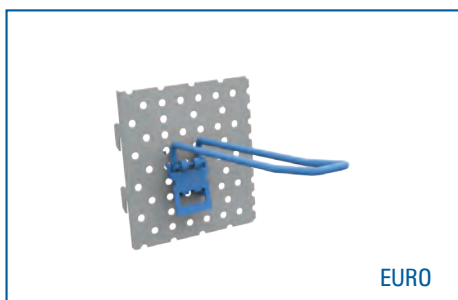

EURO

8 Wieszak • Hook • Broche • Halter • Крючок

| ∅ | D   | Code            |
|---|-----|-----------------|
| 5 | 80  | WT-N21005080-00 |
| 5 | 200 | WT-N21005200-00 |

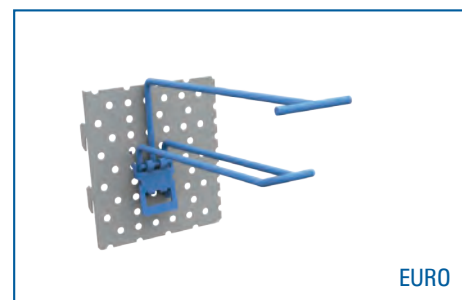

EURO

9 Wieszak • Hook • Broche • Halter • Крючок

| ∅ | D   | Code            |
|---|-----|-----------------|
| 5 | 100 | WT-N21105100-00 |
| 5 | 200 | WT-N21105200-00 |
| 5 | 300 | WT-N21105300-00 |



H- 1700

L- 1000

D-570

## Hooks (For Panel & Spacewall back panels)



H- 1700

L- 1000 (3x)

D-570

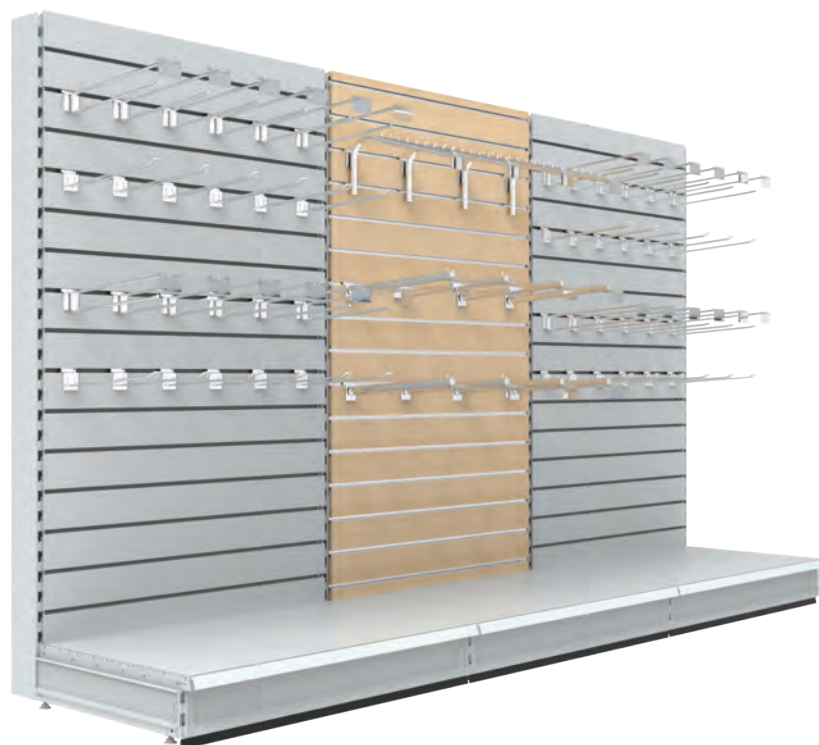

Akcesoria

Accessories

Accessoires

Zubehör

Аксессуары

## Hooks

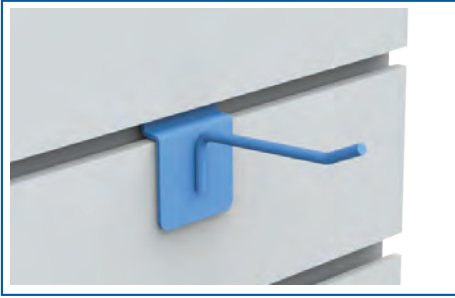

**1** Wieszak • Hook • Broche • Halter • Крючок

| ∅ | D   | Code            |
|---|-----|-----------------|
| 5 | 100 | WP-A02105100-00 |
| 5 | 200 | WP-A02105200-00 |
| 5 | 300 | WP-A02105300-00 |



**2** Wieszak • Hook • Broche • Halter • Крючок

| ∅ | D   | Code            |
|---|-----|-----------------|
| 5 | 100 | WP-A02205100-00 |
| 5 | 150 | WP-A02205150-00 |
| 5 | 200 | WP-A02205200-00 |



**3** Wieszak • Hook • Broche • Halter • Крючок

| ∅ | D   | Code            |
|---|-----|-----------------|
| 6 | 160 | WP-A07106160-00 |



**4** Wieszak • Hook • Broche • Halter • Крючок

| ∅ | D   | Code            |
|---|-----|-----------------|
| 5 | 100 | WP-A07405100-00 |
| 5 | 150 | WP-A07405150-00 |
| 5 | 200 | WP-A07405200-00 |

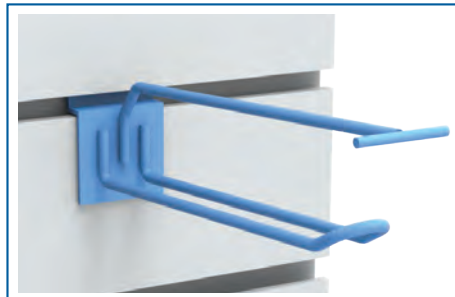

**5** Wieszak • Hook • Broche • Halter • Крючок

| ∅ | D   | Code            |
|---|-----|-----------------|
| 5 | 150 | WP-A07305150-00 |
| 5 | 200 | WP-A07305200-00 |



**6** Wieszak • Hook • Broche • Halter • Крючок

| ∅  | D   | Code            |
|----|-----|-----------------|
| 20 | 400 | WP-A08720400-00 |



**7** Wieszak • Hook • Broche • Halter • Крючок

| D   | Code            |
|-----|-----------------|
| 400 | WP-A08520400-00 |



**8** Wieszak • Hook • Broche • Halter • Крючок

| H   | D   | Code            |
|-----|-----|-----------------|
| 200 | 400 | WP-A08620400-00 |



**9** Wieszak • Hook • Broche • Halter • Крючок

| D   | Diameter | Code            |
|-----|----------|-----------------|
| 130 | 80       | WP-A02706050-00 |

H- 1700

L- 900

D-570

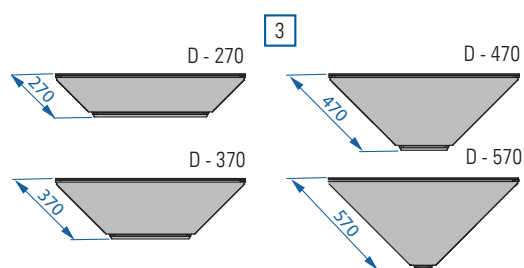
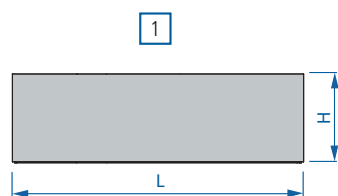
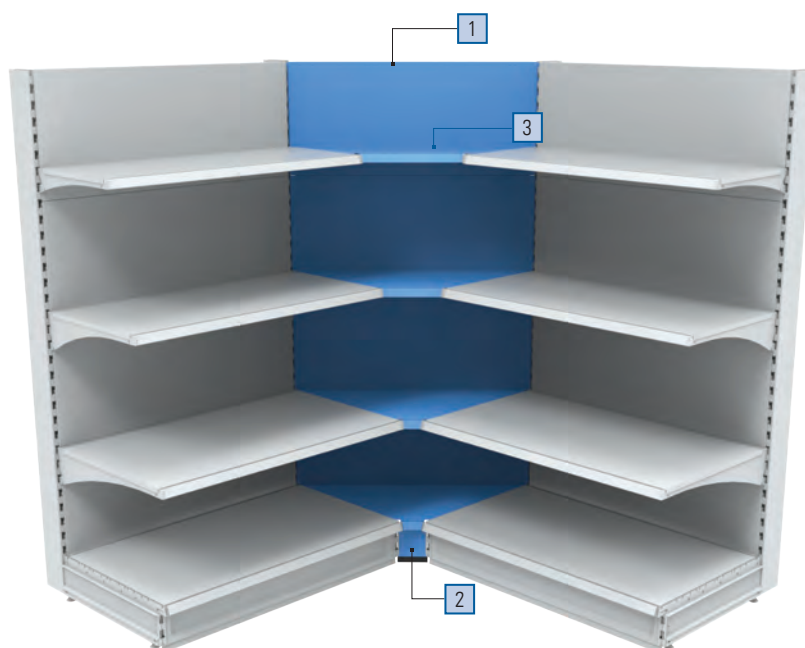
**Corners**  
**Plain Inner**

**1** Tyły • Back panels  
 Fonds • Rückwände • Задние стенки

| H   | Code            |
|-----|-----------------|
| 100 | ME-T02100900-00 |
| 200 | ME-T02200900-00 |
| 300 | ME-T02300900-00 |
| 400 | ME-T02400900-00 |

**2** Osłona dolna • Plinth  
 Plinthe • Sockelblende • Плинтус

| D   | Code            |
|-----|-----------------|
| 270 | OS-D87150270-00 |
| 370 | OS-D87150370-00 |
| 470 | OS-D87150470-00 |
| 570 | OS-D87150570-00 |

**3** Półka • Shelf  
 Tablette • Fachboden • Полка

| D   | Code            |
|-----|-----------------|
| 270 | NE-P02270860-00 |
| 370 | NE-P02370860-00 |
| 470 | NE-P02470860-00 |
| 570 | NE-P02570860-00 |

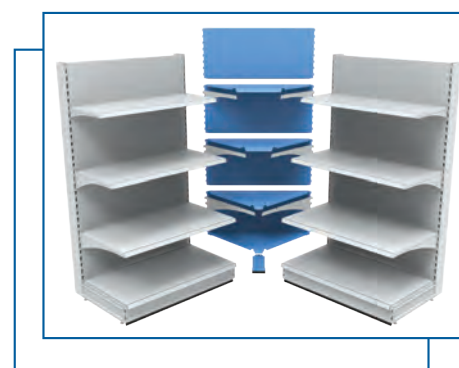
 For bracket selection see page 12-13

H- 1700

L- 180

D-570

**Corners  
Plain Outer**

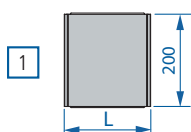
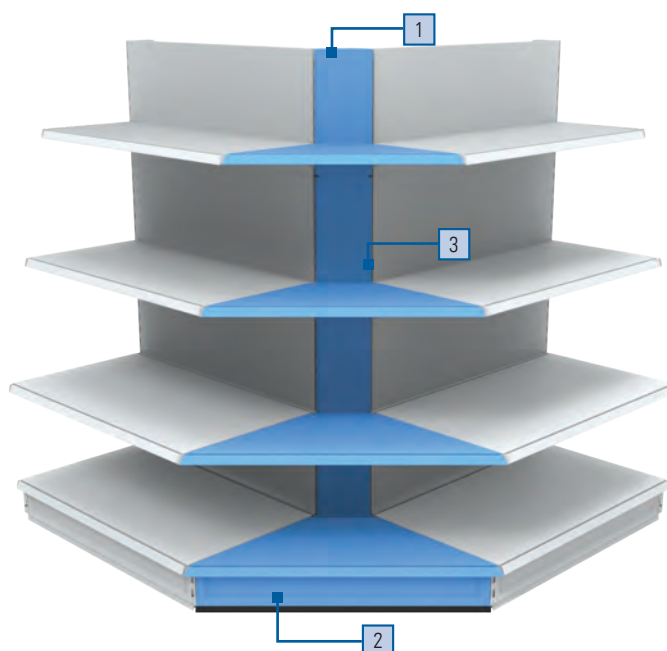

3

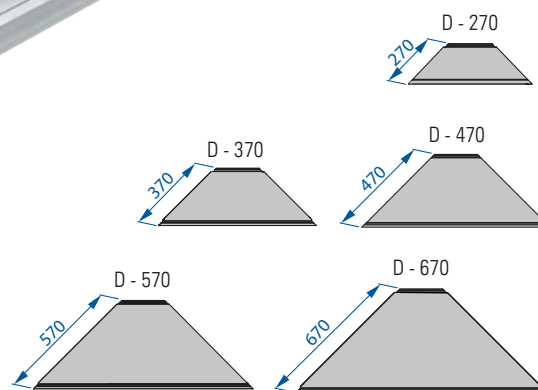

**1** Tyły • Back panels  
Fonds • Rückwände • Задние стенки

| H   | Code            |
|-----|-----------------|
| 100 | ME-T03100200-00 |
| 200 | ME-T03200200-00 |
| 300 | ME-T03300200-00 |
| 400 | ME-T03400200-00 |

**2** Oslona dolna • Plinth  
Plinthe • Sockelblende • Плинтус

| D   | Code            |
|-----|-----------------|
| 270 | OS-D89150270-00 |
| 370 | OS-D89150370-00 |
| 470 | OS-D89150470-00 |
| 570 | OS-D89150570-00 |
| 670 | OS-D89150670-00 |

**3** Półka • Shelf  
Tablette • Fachboden • Полка

| D   | Code            |
|-----|-----------------|
| 270 | NE-P03270200-00 |
| 370 | NE-P03370200-00 |
| 470 | NE-P03470200-00 |
| 570 | NE-P03570200-00 |
| 670 | NE-P03670200-00 |

**!** For bracket selection see page 12-13

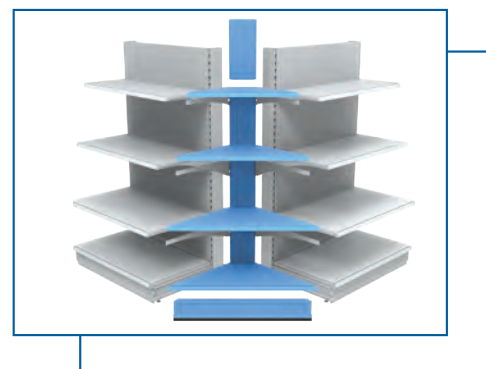

H- 900

L- 670

D-570

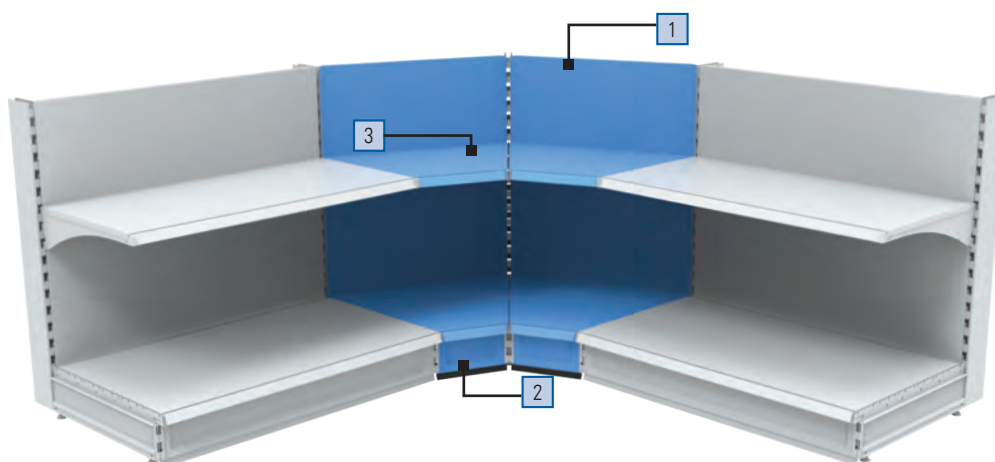
**Corners**  
**45° Inner**

1

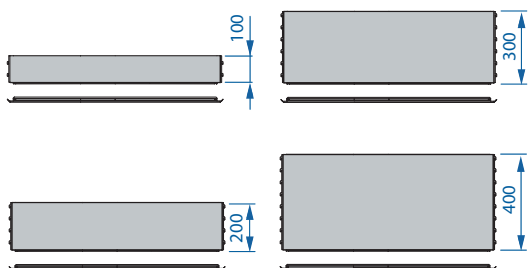

3

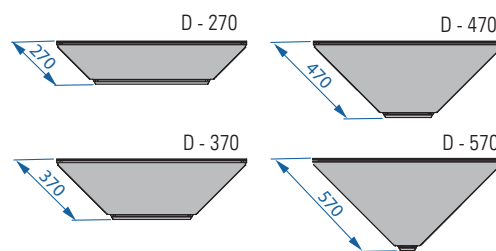

1

 Tyl • Back panels  
 Fonds • Rückwände • Задние стенки

| H   | Code            |
|-----|-----------------|
| 100 | TE-T02100670-00 |
| 200 | TE-T02200670-00 |
| 300 | TE-T02300670-00 |
| 400 | TE-T02400670-00 |

2

 Oslona dolna • Plinth  
 Plinthe • Sockelblende • Плинтус

| D   | Code            |
|-----|-----------------|
| 270 | OS-D77150270-00 |
| 370 | OS-D77150370-00 |
| 470 | OS-D77150470-00 |
| 570 | OS-D77150570-00 |
| 670 | OS-D77150670-00 |

3

 Pólka • Shelf  
 Tablette • Fachboden • Полка

| D   | Code            |
|-----|-----------------|
| 270 | TE-P02270670-00 |
| 370 | TE-P02370670-00 |
| 470 | TE-P02470670-00 |
| 570 | TE-P02570670-00 |

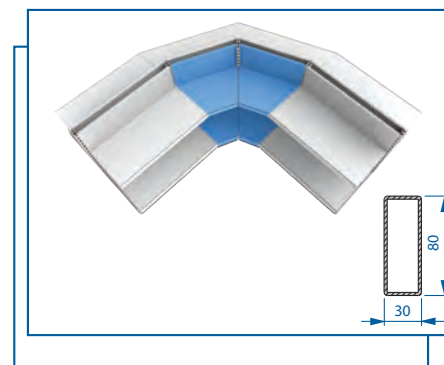

For bracket selection see page 12-13

 Wall units: 30×60 30×80 30×110  
 Gondola units: 30×80

H- 900 L- 730 D-570

**Corners**  
**45° Outer**

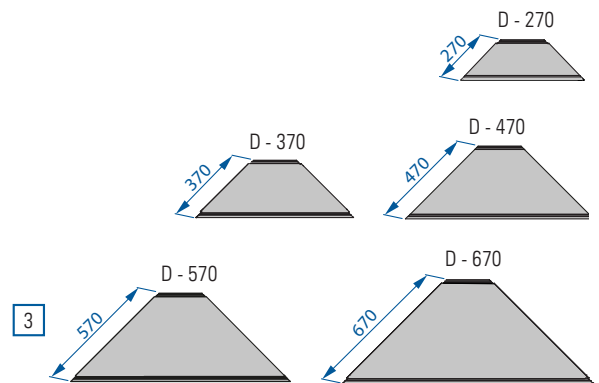
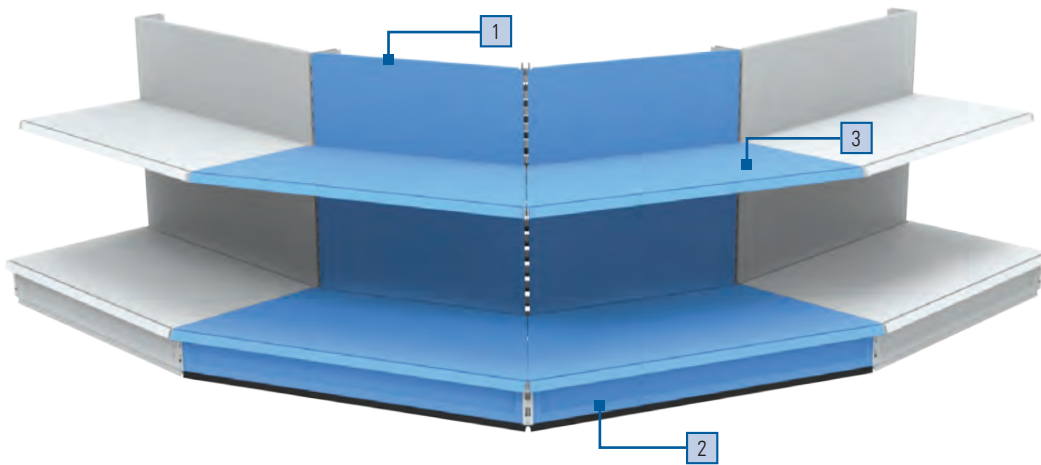

**1** Tyły • Back panels  
Fonds • Rückwände • Задние стенки

| H   | Code            |
|-----|-----------------|
| 100 | TE-T03100730-00 |
| 200 | TE-T03200730-00 |
| 300 | TE-T03300730-00 |
| 400 | TE-T03400730-00 |

**2** Oslona dolna • Plinth  
Plinthe • Sockelblende • Плинтус

| D   | Code            |
|-----|-----------------|
| 270 | OS-D83150270-00 |
| 370 | OS-D83150370-00 |
| 470 | OS-D83150470-00 |
| 570 | OS-D83150570-00 |
| 670 | OS-D83150670-00 |

**3** Półka • Shelf  
Tablette • Fachboden • Полка

| D   | Code            |
|-----|-----------------|
| 270 | TE-P03270730-00 |
| 370 | TE-P03370730-00 |
| 470 | TE-P03470730-00 |
| 570 | TE-P03570730-00 |
| 670 | TE-P03670730-00 |

**!** For bracket selection see page 12-13

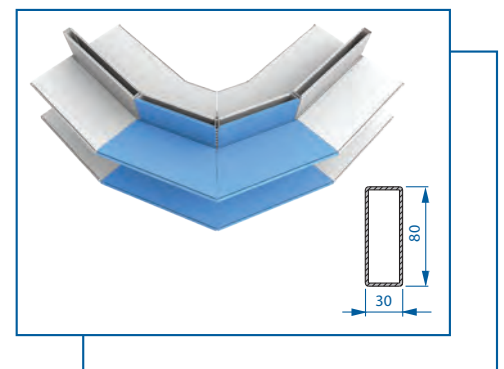

**!** Wall units: 30×60 30×80 30×110  
Gondola units: 30×80

H- 1700

L- 670

D-570

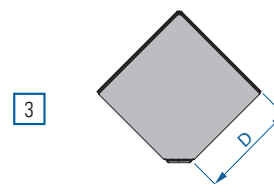
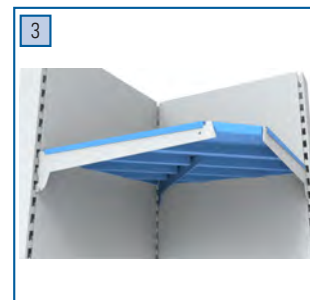
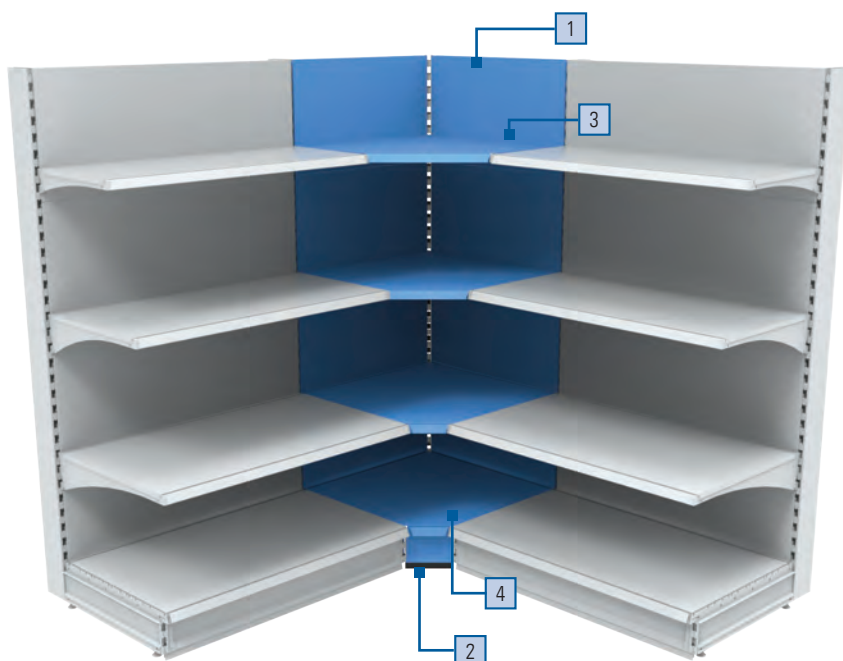
**Corners**  
 90°

**1** Tyły • Back panels  
 Fonds • Rückwände • Задние стенки

| H   | ◀ Code          | Code ▶          |
|-----|-----------------|-----------------|
| 100 | TE-T08100670-00 | TE-T09100670-00 |
| 200 | TE-T08200670-00 | TE-T09200670-00 |
| 300 | TE-T08300670-00 | TE-T09300670-00 |
| 400 | TE-T08400670-00 | TE-T09400670-00 |

**2** Oslona dolna • Plinth  
 Plinthe • Sockelblende • Плинтус

| D   | Code            |
|-----|-----------------|
| 270 | OS-D75150270-00 |
| 370 | OS-D75150370-00 |
| 470 | OS-D75150470-00 |
| 570 | OS-D75150570-00 |

**3** Półka • Shelf  
 Tablette • Fachboden • Полка

| G   | Kod          | (i) |
|-----|--------------|-----|
| 270 | TE-P09270670 | X   |
| 370 | TE-P09370670 | X   |
| 470 | TE-P09470670 | X   |
| 570 | TE-P09570670 | X   |

**4** Półka bazowa • Base shelf  
 Étagère de base • Grundplatte • Базовая полка

| G   | Kod          | (i) |
|-----|--------------|-----|
| 270 | TE-P08270670 | X   |
| 370 | TE-P08370670 | X   |
| 470 | TE-P08470670 | X   |
| 570 | TE-P08570670 | X   |

 For bracket selection see page 12-13

H- 1700    L- 800    D-570

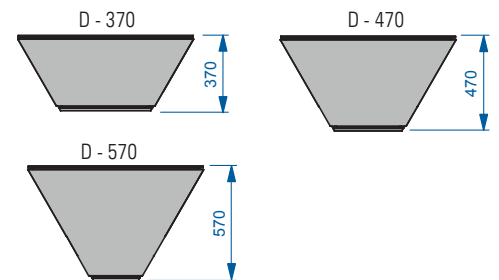
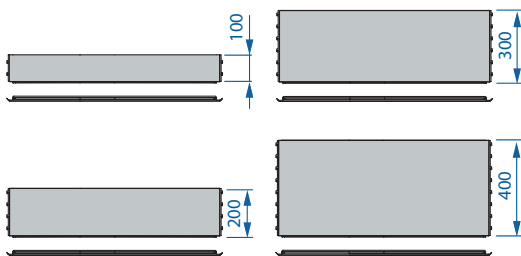
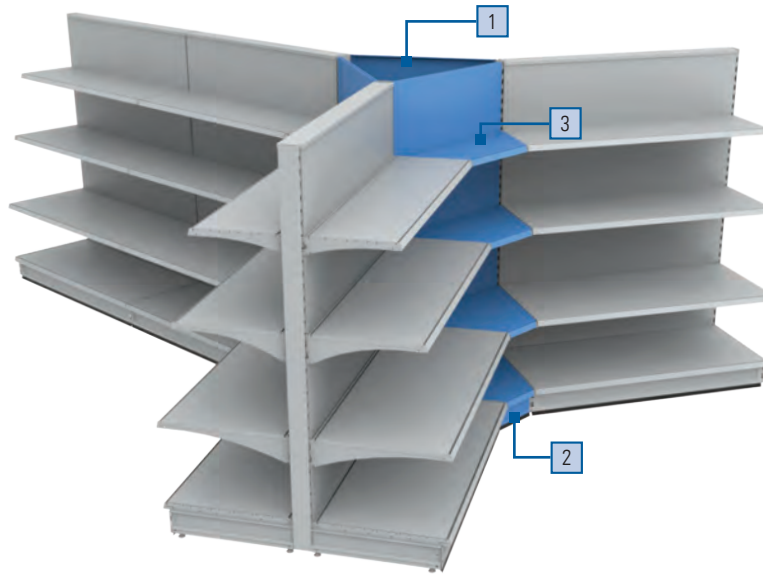

**1** Tyły • Back panels  
Fonds • Rückwände • Задние стенки

| H   | Code            |
|-----|-----------------|
| 100 | MM-T79100800-00 |
| 200 | MM-T79200800-00 |
| 300 | MM-T79300800-00 |
| 400 | MM-T79400800-00 |

**2** Osłona dolna • Plinth  
Plinthe • Sockelblende • Плинтус

| D   | Code            |
|-----|-----------------|
| 370 | OS-D91150370-00 |
| 470 | OS-D91150470-00 |
| 570 | OS-D91150570-00 |

**3** Półka • Shelf  
Tablette • Fachboden • Полка

| D   | Code            |
|-----|-----------------|
| 370 | MM-P79370800-00 |
| 470 | MM-P79470800-00 |
| 570 | MM-P79570800-00 |

**!** For bracket selection see page 12-13

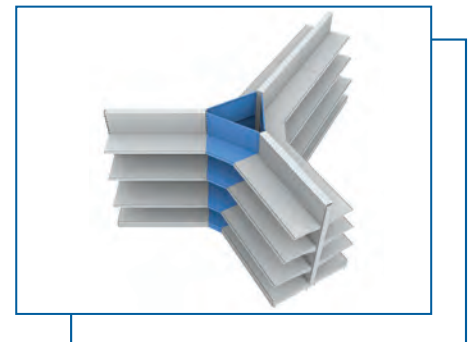



H- 2200

L- 1000

D-570

## Dedicated Solutions (for MDF, BOARDS)

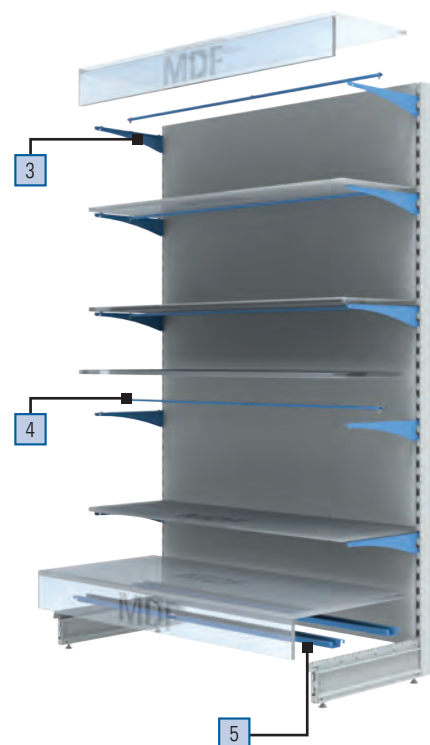

For above presented solution 80×30 Drilled Uprights must be used !!

### 1 TIE BAR (required shelving reinforcement) • Belka Bar • Barre de renfort • Verstärkung • Балка усиления

| L    | Code            |
|------|-----------------|
| 600  | TE-B00020600-00 |
| 665  | TE-B00020665-00 |
| 800  | TE-B00020800-00 |
| 1000 | TE-B00021000-00 |
| 1250 | TE-B00021250-00 |
| 1330 | TE-B00021333-00 |

### 2 MDF FIX • Uchwyt • Fixing Fixation • Befestigung • Крепёж

| Fixation | Code            |
|----------|-----------------|
| Left     | CE-A00650100-00 |
| Right    | CE-A00660100-00 |

### 4 Wzmocnienie • Reinforcement Reinforcement • Verstärkung • Упрочнение

| L    | Code            |
|------|-----------------|
| 600  | ME-A43620600-00 |
| 665  | ME-A43620665-00 |
| 800  | ME-A43620800-00 |
| 1000 | ME-A43621000-00 |
| 1250 | ME-A43621250-00 |
| 1330 | ME-A43621330-00 |

### 5 Wzmocnienie • Reinforcement Reinforcement • Verstärkung • Упрочнение

| L    | Code            |
|------|-----------------|
| 600  | ME-A50700600-00 |
| 665  | ME-A50700665-00 |
| 800  | ME-A50700800-00 |
| 1000 | ME-A50701000-00 |
| 1250 | ME-A50701250-00 |
| 1330 | ME-A50701330-00 |

### 3 Wspornik • Bracket • Console Konsole • Кронштейн

| D   | Left            | Right           |
|-----|-----------------|-----------------|
| 170 | ME-W10060170-00 | ME-W10070170-00 |
| 220 | ME-W10060220-00 | ME-W10070220-00 |
| 270 | ME-W10060270-00 | ME-W10070270-00 |
| 370 | ME-W10060370-00 | ME-W10070370-00 |
| 470 | ME-W10060470-00 | ME-W10070470-00 |

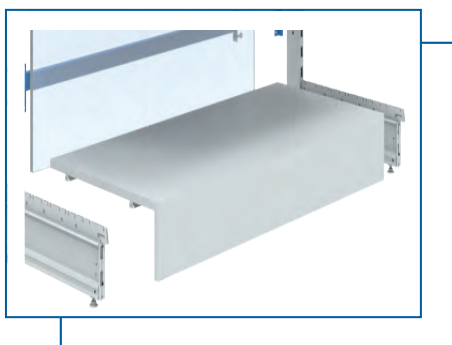

H- 2200 L- 1000 D-570

**Dedicated Solutions**  
(for MDF, BOARDS)

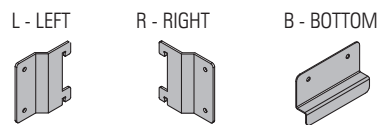
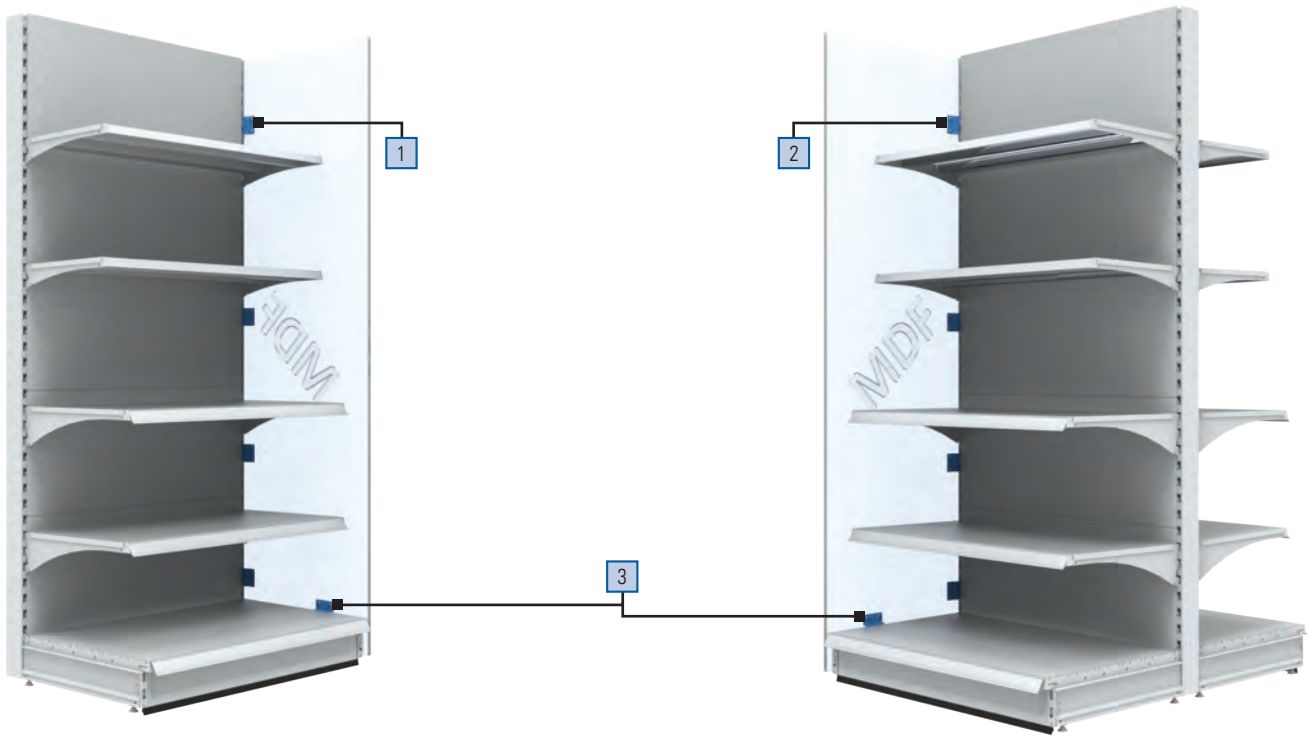

**1** Uchwyt lewy • Fixing left  
Fixation • Befestigung • Крепёж

| L | Code            |
|---|-----------------|
| L | CB-A40190065-00 |

**2** Uchwyt prawy • Fixing right  
Fixation • Befestigung • Крепёж

| L | Code            |
|---|-----------------|
| R | CB-A40200065-00 |

**3** Uchwyt dolny • Fixing bottom  
Fixation • Befestigung • Крепёж

| L | Code            |
|---|-----------------|
| B | ME-A40330080-00 |

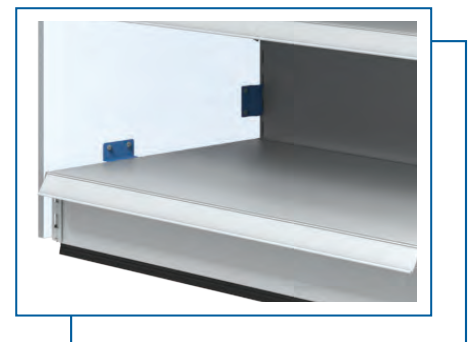

## Other Elements

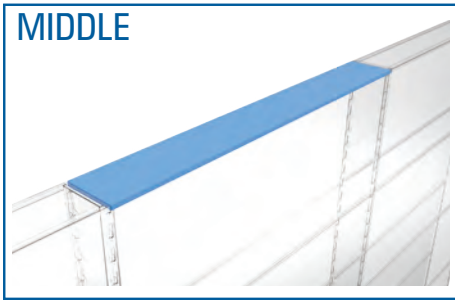

**1** Osłona środkowa • Middle top cover • Cache de milieu  
Abschlußabdeckung mittig • Крышка гондолы средняя

| L    | Code            | Code            |
|------|-----------------|-----------------|
| 600  | OS-G03220600-00 | OS-G03320600-00 |
| 665  | OS-G03220665-00 | OS-G03320665-00 |
| 800  | OS-G03220800-00 | OS-G03320800-00 |
| 1000 | OS-G03221000-00 | OS-G03321000-00 |
| 1200 | OS-G03221200-00 | OS-G03321200-00 |
| 1250 | OS-G03221250-00 | OS-G03321250-00 |
| 1330 | OS-G03221330-00 | OS-G03321330-00 |

| a × b | 60 × 30 | 80 × 30 |
|-------|---------|---------|
|       |         |         |

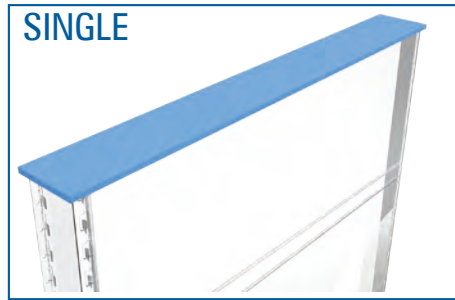

**2** Osłona pojedyncza • Single top cover • Cache simple  
Abschlußabdeckung einfach • Крышка гондолы одинарная

| L    | Code            | Code            |
|------|-----------------|-----------------|
| 600  | OS-G01220600-00 | OS-G01320600-00 |
| 665  | OS-G01220665-00 | OS-G01320665-00 |
| 800  | OS-G01220800-00 | OS-G01320800-00 |
| 1000 | OS-G01221000-00 | OS-G01321000-00 |
| 1200 | OS-G01221200-00 | OS-G01321200-00 |
| 1250 | OS-G01221250-00 | OS-G01321250-00 |
| 1330 | OS-G01221330-00 | OS-G01321330-00 |

| a × b | 60 × 30 | 80 × 30 |
|-------|---------|---------|
|       |         |         |

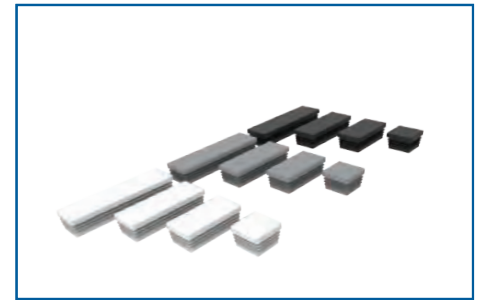

**3** PLASTIC • Zaślepka do profilu • Upright Plug •  
Embout de montage Deckkappe für Säule • Заглушка

| a × b    | Code  | Code            |
|----------|-------|-----------------|
| 30 × 30  | BLACK | NO-Z00030030-81 |
|          | WHITE | NO-Z00030030-80 |
|          | GRAY  | NO-Z00030030-87 |
| 60 × 30  | BLACK | NO-Z00030060-81 |
|          | WHITE | NO-Z00030060-80 |
|          | GRAY  | NO-Z00030060-87 |
| 80 × 30  | BLACK | NO-Z00030080-81 |
|          | WHITE | NO-Z00030080-80 |
|          | GRAY  | NO-Z00030080-87 |
| 110 × 30 | BLACK | NO-Z00030110-87 |
|          | WHITE | NO-Z00030110-81 |
|          | GRAY  | NO-Z00030110-87 |

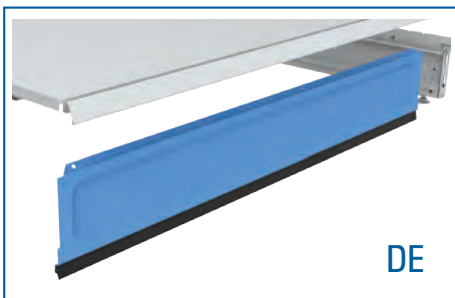

**4** DE • Osłona dolna • Plinth • Plinthe  
Sockelblende • Плинтус

| L    | Code            |
|------|-----------------|
| 600  | OS-D71150600-00 |
| 665  | OS-D71150665-00 |
| 800  | OS-D71150800-00 |
| 1000 | OS-D71151000-00 |
| 1250 | OS-D71151250-00 |
| 1330 | OS-D71151330-00 |

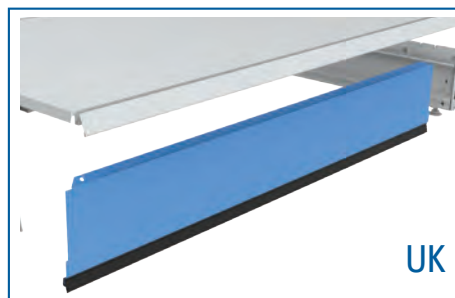

**5** UK • Osłona dolna • Plinth • Plinthe  
Sockelblende • Плинтус

| L    | Code            |
|------|-----------------|
| 600  | OS-D73150600-00 |
| 665  | OS-D73150665-00 |
| 800  | OS-D73150800-00 |
| 1000 | OS-D73151000-00 |
| 1200 | OS-D73151200-00 |
| 1250 | OS-D73151250-00 |
| 1330 | OS-D73151330-00 |

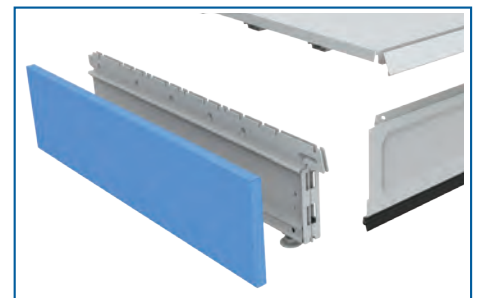

**6** Osłona stopy • Foot cover • Cache pied  
Sockelverkleidung • Боковая защита стопы

| D   | <- Code         | Code ->         |
|-----|-----------------|-----------------|
| 370 | TE-A01130370-00 | TE-A01140370-00 |
| 470 | TE-A01130470-00 | TE-A01140470-00 |
| 570 | TE-A01130570-00 | TE-A01140570-00 |
| 670 | TE-A01130670-00 | TE-A01140670-00 |
| 770 | TE-A01130770-00 | TE-A01140770-00 |

## Other Elements



**1** Mocowanie (do ściany) • Wall fix • Fixation (au mur)  
Befestigung (an die Wand) • Крепление (к стене)

| L  | H  | Code            |
|----|----|-----------------|
| 20 | 60 | TE-A69402060-00 |

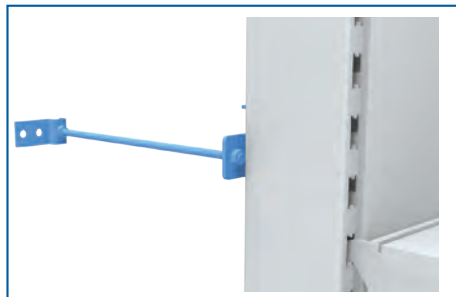

**2** Mocowanie (do ściany) • Wall fix • Fixation (au mur)  
Befestigung (an die Wand) • Крепление (к стене)

| L   | Code            |
|-----|-----------------|
| 200 | CE-A00340200-50 |
| 300 | CE-A00340300-50 |
| 400 | CE-A00340400-50 |

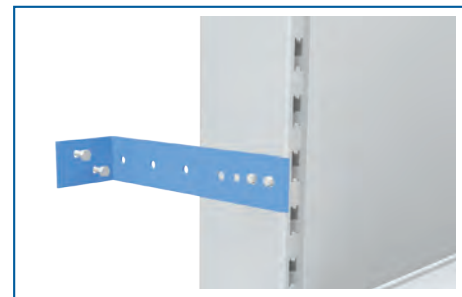

**3** Mocowanie (do ściany) • Wall fix • Fixation (au mur)  
Befestigung (an die Wand) • Крепление (к стене)

| L   | Code            |
|-----|-----------------|
| 200 | ME-A03710200-00 |
| 300 | ME-A03710300-00 |
| 400 | ME-A03710400-00 |



**5** Stopka • Adjusting screw  
Vérin • Fußsteller • Винтовая опора (с регулировкой высоты)

| Code            |
|-----------------|
| ME-A00000005-50 |



**4** Mocowanie • Anchoring set •  
Fixation • Befestigung • Крепление

| Code            |
|-----------------|
| ME-A28010060-00 |

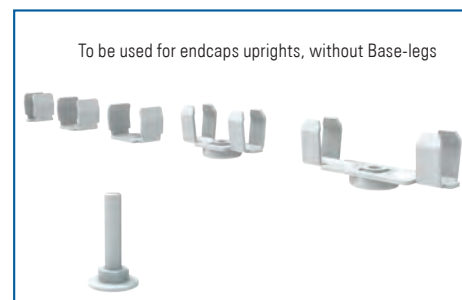

**7** Wkładka • Insert •  
Insert • Rohreinsatz • Вкладка торцевой стойки

| Element | Size   | Code            |
|---------|--------|-----------------|
| Insert  | 30x30  | VV-A01700030-50 |
| Insert  | 60x30  | VV-A01700060-50 |
| Insert  | 80x30  | VV-A01700080-50 |
| Insert  | 110x30 | VV-A01700110-50 |



**5** Przedłużka • Extension  
Réhausse • Verlängerung • Удлинитель

| Upright | L   | Code            |
|---------|-----|-----------------|
| 60×30   | 100 | ME-A69906010-00 |
| 60×30   | 200 | ME-A69906020-00 |
| 60×30   | 400 | ME-A69906040-00 |
| 60×30   | 600 | ME-A69906060-00 |

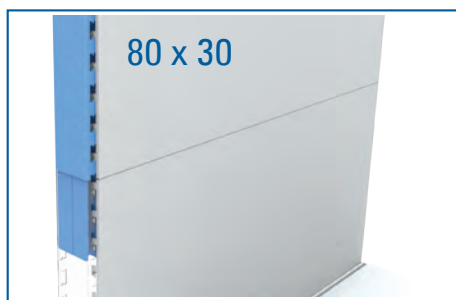

**5** Przedłużka • Extension  
Réhausse • Verlängerung • Удлинитель

| Upright | L   | Code            |
|---------|-----|-----------------|
| 80×30   | 100 | ME-A69908010-00 |
| 80×30   | 200 | ME-A69908020-00 |
| 80×30   | 400 | ME-A69908040-00 |
| 80×30   | 600 | ME-A69908060-00 |

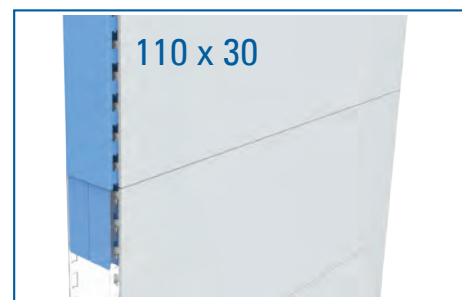

**5** Przedłużka • Extension  
Réhausse • Verlängerung • Удлинитель

| Upright | L   | Code            |
|---------|-----|-----------------|
| 110×30  | 100 | ME-A69901010-00 |
| 110×30  | 200 | ME-A69901020-00 |
| 110×30  | 400 | ME-A69901040-00 |
| 110×30  | 600 | ME-A69901060-00 |

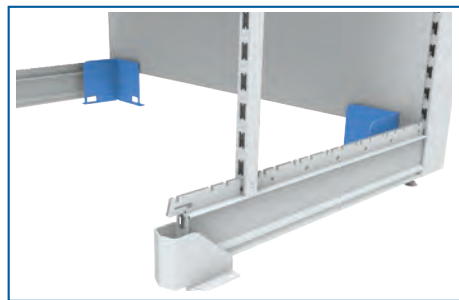
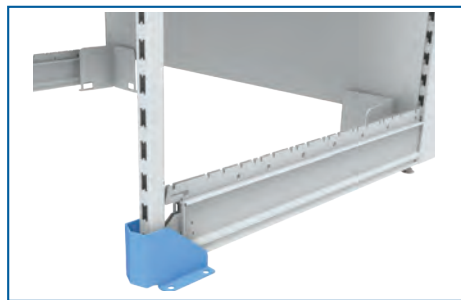

**1** Odbojnik palety  
 Pallet guard • Butée • Abweiser • Отбойник

|       | Code            |
|-------|-----------------|
| Front | ME-A36990140-00 |

**2** Odbojnik palety  
 Pallet guard • Butée • Abweiser • Отбойник

|      | Code            |
|------|-----------------|
| Rear | ME-A36940150-00 |

**3** Kotek • Peg  
 Cheville • Hochleistungsanker • Анкерный болт

| screw | sleeve | Code            |
|-------|--------|-----------------|
| 10x60 | 20x56  | NO-000000120-50 |

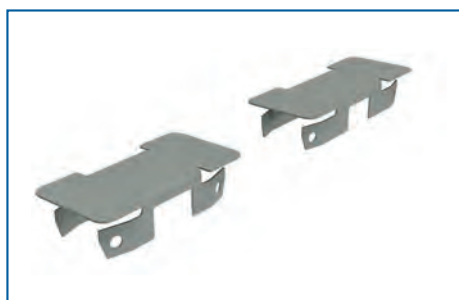









**4** Mocowanie (do ściany) • Wall fix • Fixation (au mur)  
 Befestigung (an die Wand) • Крепление (к стене)

|            | Code            |
|------------|-----------------|
| 30 × 90 ∅9 | ME-A03970090-00 |

**5** Zaślepka metalowa • Metal cap • Deckkappe Metall  
 Embout métallique • Металлическая заглушка

|         | Code            |
|---------|-----------------|
| 30 × 60 | NO-Z08130060-00 |
| 30 × 80 | NO-Z08130080-00 |

|   |                               |   |                               |
|---|-------------------------------|---|-------------------------------|
|  | RAL 9016<br>SHM<br>STD        |  | RAL 7035<br>SHM<br>STD        |
|  | RAL 9005<br>SRU<br>STD        |  | RAL 9006<br>METALICZNY<br>EXT |
|  | TIGER 09/80170<br>G<br>EXT    |  | RAL 9001<br>SHM<br>STD        |
|  | RAL 9010<br>G<br>STD          |  | RAL 7016<br>G<br>STD          |
|  | RAL 9007<br>Metaliczny<br>EXT |   |                               |



Symbole: G – polysk; M – mat; SM – gladki, matowy; SHM – gladki, półmatowy;  
SRU – strukturalny; HSRU – mlotkowy, strukturalny; STD – farba standardowa; EXT – farba specjalna

Symbols: G – gloss; M – mat; SM – smooth mat; SHM – smooth, half-mat;  
SRU – structural; HSRU – hammer paint; STD – standard paint; EXT – special paint

Symboles: G – brillant; M – opaque; SM – lisse, opaque; SHM – lisse, demi-opaque;  
SRU – structural; HSRU – de marteau, structural; STD – peinture standard; EXT – peinture spéciale

Symbole: G – glanz; M – matt; SM – glatt, matt; SHM – glatt, halbmatt;  
SRU – strukturiert; HSRU – hammereffekt, strukturiert; STD – Standardfarbe; EXT – Sonderfarbe

Символы: G – глянец; M – матовый; SM – гладкий матовый; SHM – гладкий полуматовый;  
SRU – шагрень; HSRU – Шагрень текстурная; STD – Стандартный цвет; EXT – Специальный цвет



## Product's TAG

| CODE            | TAG      | CODE            | TAG      | CODE            | TAG      |
|-----------------|----------|-----------------|----------|-----------------|----------|
| CE-W10290150-00 | W.OEYD   | TE-N07003150-00 | S.03N1M0 | TE-N40600190-00 | S.03N1M0 |
| ME-A05070050-50 | Z.M      | TE-N07003180-00 | S.03N1M0 | TE-N40600200-00 | S.03N1M0 |
| ME-W00430390-00 | W.M2B0   | TE-N07003190-00 | S.03N1M0 | TE-N40600210-00 | S.03N1M0 |
| ME-W00430470-00 | W.M2C0   | TE-N07003200-00 | S.03N1M0 | TE-N40600220-00 | S.03N1M0 |
| ME-W00430570-00 | W.M2D0   | TE-N07003210-00 | S.03N1M0 | TE-N40600230-00 | S.03N1M0 |
| ME-W10010200-00 | W.M2YU   | TE-N07003220-00 | S.03N1M0 | TE-N40600240-00 | S.03N1M0 |
| ME-W10010270-00 | W.M2AU   | TE-N07003230-00 | S.03N1M0 | TE-N40600250-00 | S.03N1M0 |
| ME-W10010300-00 | W.M2ZU   | TE-N07003240-00 | S.03N1M0 | TE-N40600260-00 | S.03N1M0 |
| ME-W10010370-00 | W.M2BU   | TE-N07003250-00 | S.03N1M0 | TE-N40600300-00 | S.03N1M0 |
| ME-W10010470-00 | W.M3CU   | TE-N07003260-00 | S.03N1M0 | TE-N96337011-00 | L.L11W2B |
| ME-W10010570-00 | W.M3DU   | TE-N07003300-00 | S.03N1M0 | TE-N96347011-00 | L.L11W2B |
| ME-W10020570-00 | W.M4DM   | TE-N07006110-00 | S.06W2M0 | TE-N96357011-00 | L.L11W2B |
| ME-W10020670-00 | W.M4EM   | TE-N07006120-00 | S.06W2M0 | TE-N96367011-00 | L.L11W2B |
| ME-W10020770-00 | W.M4FM   | TE-N07006140-00 | S.06W2M0 | TE-N96377011-00 | L.L11W2B |
| ME-W10030470-00 | W.M3CM   | TE-N07006160-00 | S.06W2M0 | TE-T20100600-00 | T.M10G   |
| ME-W10030570-00 | W.M3DM   | TE-N07006180-00 | S.06W2M0 | TE-T20100665-00 | T.M10G   |
| ME-W10030670-00 | W.M3ES   | TE-N07006200-00 | S.06W2M0 | TE-T20100800-00 | T.M10G   |
| ME-W12240470-00 | W.M2CU   | TE-N07006210-00 | S.06W2M0 | TE-T20101000-00 | T.M10G   |
| NE-P00200665-00 | P.2NY006 | TE-N07006220-00 | S.06W2M0 | TE-T20101250-00 | T.M10G   |
| NE-P00201000-00 | P.2NY010 | TE-N07006240-00 | S.06W2M0 | TE-T20101330-00 | T.M10G   |
| NE-P00201250-00 | P.2NY012 | TE-N07006260-00 | S.06W2M0 | TE-T20200600-00 | T.M20G   |
| NE-P00201330-00 | P.2NY013 | TE-N07006280-00 | S.06W2M0 | TE-T20200665-00 | T.M20G   |
| NE-P00270665-00 | P.2NA106 | TE-N07006300-00 | S.06W2M0 | TE-T20200800-00 | T.M20G   |
| NE-P00271000-00 | P.2NA110 | TE-N07008140-00 | S.08W2M0 | TE-T20201000-00 | T.M20G   |
| NE-P00271250-00 | P.2NA112 | TE-N07008160-00 | S.08W2M0 | TE-T20201250-00 | T.M20G   |
| NE-P00271330-00 | P.2NA113 | TE-N07008180-00 | S.08W2M0 | TE-T20201330-00 | T.M20G   |
| NE-P00370665-00 | P.2NB206 | TE-N07008200-00 | S.08W2M0 | TE-T20300600-00 | T.M30G   |
| NE-P00371000-00 | P.2NB210 | TE-N07008210-00 | S.08W2M0 | TE-T20300665-00 | T.M30G   |
| NE-P00371250-00 | P.2NB212 | TE-N07008220-00 | S.08W2M0 | TE-T20300800-00 | T.M30G   |
| NE-P00371330-00 | P.2NB213 | TE-N07008240-00 | S.08W2M0 | TE-T20301000-00 | T.M30G   |
| NE-P00470665-00 | P.2NC206 | TE-N07008260-00 | S.08W2M0 | TE-T20301250-00 | T.M30G   |
| NE-P00471000-00 | P.2NC210 | TE-N07008280-00 | S.08W2M0 | TE-T20301330-00 | T.M30G   |
| NE-P00471250-00 | P.2NC312 | TE-N07008300-00 | S.08W2M0 | TE-T20400600-00 | T.M40G   |
| NE-P00471330-00 | P.2NC313 | TE-N07011180-00 | S.11W2M0 | TE-T20400665-00 | T.M40G   |
| NE-P00570665-00 | P.2ND306 | TE-N07011200-00 | S.11W2M0 | TE-T20400800-00 | T.M40G   |
| NE-P00571000-00 | P.2ND310 | TE-N07011220-00 | S.11W2M0 | TE-T20401000-00 | T.M40G   |
| NE-P00571250-00 | P.2ND312 | TE-N07011240-00 | S.11W2M0 | TE-T20401250-00 | T.M40G   |
| NE-P00571330-00 | P.2ND313 | TE-N17006110-00 | S.06W2M0 | TE-T20401330-00 | T.M40G   |
| NE-P00670665-00 | P.2NE306 | TE-N17006120-00 | S.06W2M0 | TE-T20500600-00 | T.M50G   |
| NE-P00671000-00 | P.2NE310 | TE-N17006140-00 | S.06W2M0 | TE-T20500665-00 | T.M50G   |
| NE-P00671250-00 | P.2NE312 | TE-N17006160-00 | S.06W2M0 | TE-T20500800-00 | T.M50G   |
| NE-P00671330-00 | P.2NE313 | TE-N17006180-00 | S.06W2M0 | TE-T20501000-00 | T.M50G   |
| NE-P00770665-00 | P.2NF406 | TE-N17006200-00 | S.06W2M0 | TE-T20501250-00 | T.M50G   |
| NE-P00771000-00 | P.2NF410 | TE-N17006210-00 | S.06W2M0 | TE-T20501330-00 | T.M50G   |
| NE-P00771250-00 | P.2NF412 | TE-N17006220-00 | S.06W2M0 | TE-T21400665-00 | T.M10P   |
| NE-P00771330-00 | P.2NF413 | TE-N17008140-00 | S.08W2M0 | TE-T21401000-00 | T.M20P   |
| NE-P61210665-00 | P.0NY106 | TE-N17008160-00 | S.08W2M0 | TE-T21401250-00 | T.M30P   |
| NE-P61211000-00 | P.0NY110 | TE-N17008180-00 | S.08W2M0 | TE-T21401330-00 | T.M40P   |
| NE-P61211250-00 | P.0NY112 | TE-N17008200-00 | S.08W2M0 | TE-T22400665-00 | T.M10P   |
| NE-P61211330-00 | P.0NY113 | TE-N17008210-00 | S.08W2M0 | TE-T22401000-00 | T.M20P   |
| TE-B00020665-00 | E.2B066  | TE-N17008220-00 | S.08W2M0 | TE-T22401250-00 | T.M30P   |
| TE-B00021000-00 | E.2B100  | TE-N40600120-00 | S.03N1M0 | TE-T22401330-00 | T.M40P   |
| TE-B00021250-00 | E.2B125  | TE-N40600130-00 | S.03N1M0 | TE-W04030370-00 | W.M2B0   |
| TE-B00021333-00 | E.2B133  | TE-N40600140-00 | S.03N1M0 | TE-W04030470-00 | W.M2C0   |
| TE-N07003130-00 | S.03N1M0 | TE-N40600150-00 | S.03N1M0 | TE-W04030570-00 | W.M2D0   |
| TE-N07003160-00 | S.03N1M0 | TE-N40600170-00 | S.03N1M0 | TE-W04030670-00 | W.M2EO   |
| TE-N07003170-00 | S.03N1M0 | TE-N40600180-00 | S.03N1M0 | TE-W04030770-00 | W.M2FO   |

**Product's TAG**

| TAG      | CODE            | TAG      | CODE            | TAG    | CODE            |
|----------|-----------------|----------|-----------------|--------|-----------------|
| E.2B066  | TE-B00020665-00 | S.03N1M0 | TE-N40600140-00 | T.M10G | TE-T20101250-00 |
| E.2B100  | TE-B00021000-00 | S.03N1M0 | TE-N40600150-00 | T.M10G | TE-T20101330-00 |
| E.2B125  | TE-B00021250-00 | S.03N1M0 | TE-N40600160-00 | T.M10P | TE-T21400665-00 |
| E.2B133  | TE-B00021333-00 | S.03N1M0 | TE-N40600170-00 | T.M10P | TE-T22400665-00 |
| L.L11W2B | TE-N96337011-00 | S.03N1M0 | TE-N40600180-00 | T.M20G | TE-T20200600-00 |
| L.L11W2B | TE-N96347011-00 | S.03N1M0 | TE-N40600190-00 | T.M20G | TE-T20200665-00 |
| L.L11W2B | TE-N96357011-00 | S.03N1M0 | TE-N40600200-00 | T.M20G | TE-T20200800-00 |
| L.L11W2B | TE-N96367011-00 | S.03N1M0 | TE-N40600210-00 | T.M20G | TE-T20201000-00 |
| L.L11W2B | TE-N96377011-00 | S.03N1M0 | TE-N40600220-00 | T.M20G | TE-T20201250-00 |
| P.0NY106 | NE-P61210665-00 | S.03N1M0 | TE-N40600230-00 | T.M20G | TE-T20201330-00 |
| P.0NY110 | NE-P61211000-00 | S.03N1M0 | TE-N40600240-00 | T.M20P | TE-T21401000-00 |
| P.0NY112 | NE-P61211250-00 | S.03N1M0 | TE-N40600250-00 | T.M20P | TE-T22401000-00 |
| P.0NY113 | NE-P61211330-00 | S.03N1M0 | TE-N40600260-00 | T.M30G | TE-T20300600-00 |
| P.2NA106 | NE-P00270665-00 | S.03N1M0 | TE-N40600300-00 | T.M30G | TE-T20300665-00 |
| P.2NA110 | NE-P00271000-00 | S.06W2M0 | TE-N07006110-00 | T.M30G | TE-T20300800-00 |
| P.2NA112 | NE-P00271250-00 | S.06W2M0 | TE-N07006120-00 | T.M30G | TE-T20301000-00 |
| P.2NA113 | NE-P00271330-00 | S.06W2M0 | TE-N07006140-00 | T.M30G | TE-T20301250-00 |
| P.2NB206 | NE-P00370665-00 | S.06W2M0 | TE-N07006160-00 | T.M30G | TE-T20301330-00 |
| P.2NB210 | NE-P00371000-00 | S.06W2M0 | TE-N07006180-00 | T.M30P | TE-T21401250-00 |
| P.2NB212 | NE-P00371250-00 | S.06W2M0 | TE-N07006200-00 | T.M30P | TE-T22401250-00 |
| P.2NB213 | NE-P00371330-00 | S.06W2M0 | TE-N07006210-00 | T.M40G | TE-T20400600-00 |
| P.2NC206 | NE-P00470665-00 | S.06W2M0 | TE-N07006220-00 | T.M40G | TE-T20400665-00 |
| P.2NC210 | NE-P00471000-00 | S.06W2M0 | TE-N07006240-00 | T.M40G | TE-T20400800-00 |
| P.2NC312 | NE-P00471250-00 | S.06W2M0 | TE-N07006260-00 | T.M40G | TE-T20401000-00 |
| P.2NC313 | NE-P00471330-00 | S.06W2M0 | TE-N07006280-00 | T.M40G | TE-T20401250-00 |
| P.2ND306 | NE-P00570665-00 | S.06W2M0 | TE-N07006300-00 | T.M40G | TE-T20401330-00 |
| P.2ND310 | NE-P00571000-00 | S.06W2M0 | TE-N17006110-00 | T.M40P | TE-T21401330-00 |
| P.2ND312 | NE-P00571250-00 | S.06W2M0 | TE-N17006120-00 | T.M40P | TE-T22401330-00 |
| P.2ND313 | NE-P00571330-00 | S.06W2M0 | TE-N17006140-00 | T.M50G | TE-T20500600-00 |
| P.2NE306 | NE-P00670665-00 | S.06W2M0 | TE-N17006160-00 | T.M50G | TE-T20500665-00 |
| P.2NE310 | NE-P00671000-00 | S.06W2M0 | TE-N17006180-00 | T.M50G | TE-T20500800-00 |
| P.2NE312 | NE-P00671250-00 | S.06W2M0 | TE-N17006200-00 | T.M50G | TE-T20501000-00 |
| P.2NE313 | NE-P00671330-00 | S.06W2M0 | TE-N17006210-00 | T.M50G | TE-T20501250-00 |
| P.2NF406 | NE-P00770665-00 | S.06W2M0 | TE-N17006220-00 | T.M50G | TE-T20501330-00 |
| P.2NF410 | NE-P00771000-00 | S.08W2M0 | TE-N07008140-00 | W.M2AU | ME-W10010270-00 |
| P.2NF412 | NE-P00771250-00 | S.08W2M0 | TE-N07008160-00 | W.M2BO | ME-W00430390-00 |
| P.2NF413 | NE-P00771330-00 | S.08W2M0 | TE-N07008180-00 | W.M2BO | TE-W04030370-00 |
| P.2NY006 | NE-P00200665-00 | S.08W2M0 | TE-N07008200-00 | W.M2BU | ME-W10010370-00 |
| P.2NY010 | NE-P00201000-00 | S.08W2M0 | TE-N07008210-00 | W.M2CO | ME-W00430470-00 |
| P.2NY012 | NE-P00201250-00 | S.08W2M0 | TE-N07008220-00 | W.M2CO | TE-W04030470-00 |
| P.2NY013 | NE-P00201330-00 | S.08W2M0 | TE-N07008240-00 | W.M2CU | ME-W12240470-00 |
| S.03N1M0 | TE-N07003130-00 | S.08W2M0 | TE-N07008260-00 | W.M2DO | ME-W00430570-00 |
| S.03N1M0 | TE-N07003140-00 | S.08W2M0 | TE-N07008280-00 | W.M2DO | TE-W04030570-00 |
| S.03N1M0 | TE-N07003150-00 | S.08W2M0 | TE-N07008300-00 | W.M2EO | TE-W04030670-00 |
| S.03N1M0 | TE-N07003160-00 | S.08W2M0 | TE-N17008140-00 | W.M2FO | TE-W04030770-00 |
| S.03N1M0 | TE-N07003170-00 | S.08W2M0 | TE-N17008160-00 | W.M2YU | ME-W10010200-00 |
| S.03N1M0 | TE-N07003180-00 | S.08W2M0 | TE-N17008180-00 | W.M2ZU | ME-W10010300-00 |
| S.03N1M0 | TE-N07003190-00 | S.08W2M0 | TE-N17008200-00 | W.M3CU | ME-W10010470-00 |
| S.03N1M0 | TE-N07003200-00 | S.08W2M0 | TE-N17008210-00 | W.M3DM | ME-W10030570-00 |
| S.03N1M0 | TE-N07003210-00 | S.08W2M0 | TE-N17008220-00 | W.M3DU | ME-W10010570-00 |
| S.03N1M0 | TE-N07003220-00 | S.11W2M0 | TE-N07011180-00 | W.M3ES | ME-W10030670-00 |
| S.03N1M0 | TE-N07003230-00 | S.11W2M0 | TE-N07011200-00 | W.M3CM | ME-W10030470-00 |
| S.03N1M0 | TE-N07003240-00 | S.11W2M0 | TE-N07011220-00 | W.M4DM | ME-W10020570-00 |
| S.03N1M0 | TE-N07003250-00 | S.11W2M0 | TE-N07011240-00 | W.M4EM | ME-W10020670-00 |
| S.03N1M0 | TE-N07003260-00 | T.M10G   | TE-T20100600-00 | W.M4FM | ME-W10020770-00 |
| S.03N1M0 | TE-N07003300-00 | T.M10G   | TE-T20100665-00 | W.OEYD | CE-W10290150-00 |
| S.03N1M0 | TE-N40600120-00 | T.M10G   | TE-T20100800-00 | Z.M    | ME-A05070050-50 |



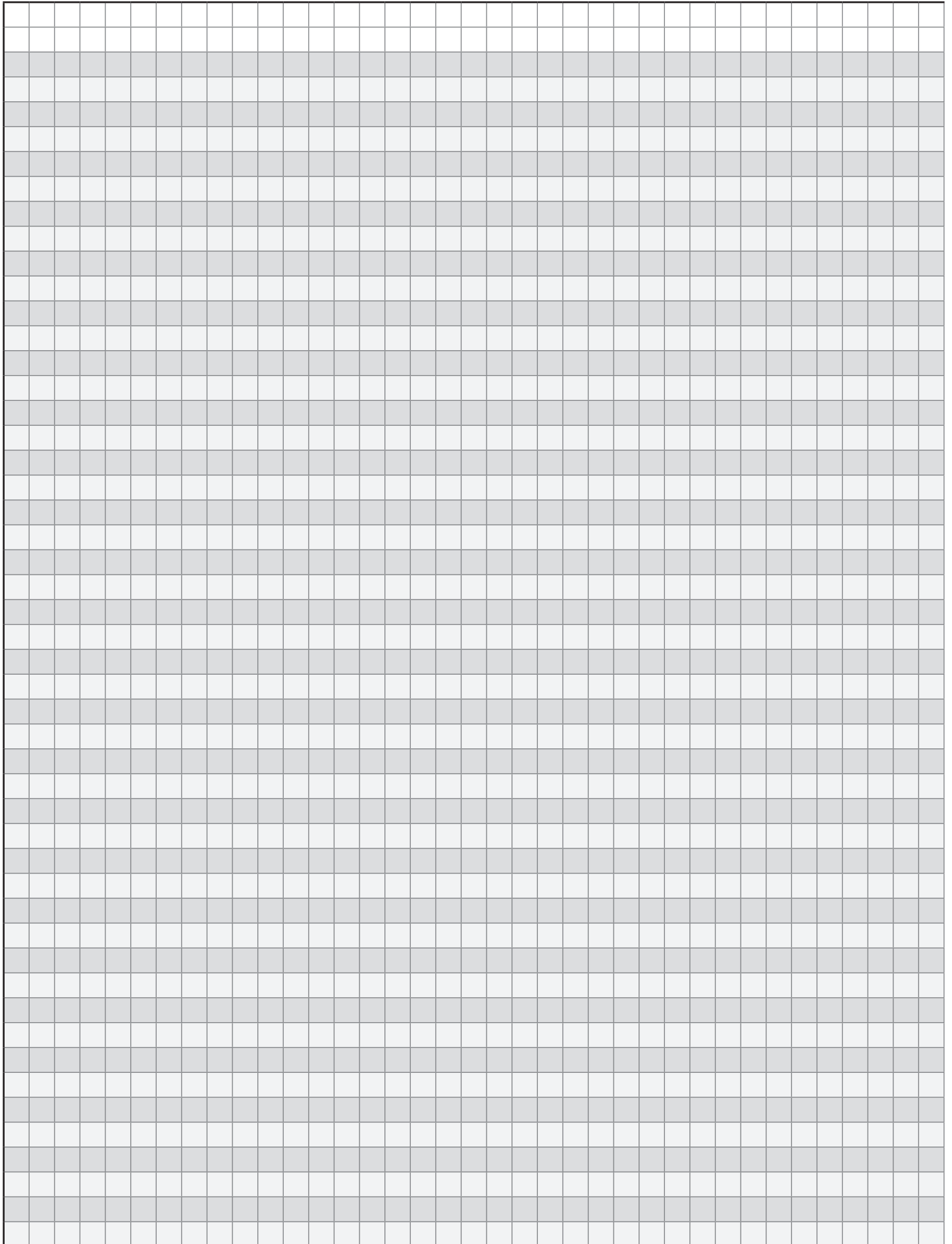



**SMARTLINE**   
WINKELINTERIEUR