

SMARTLINE

WINKELINTERIEUR

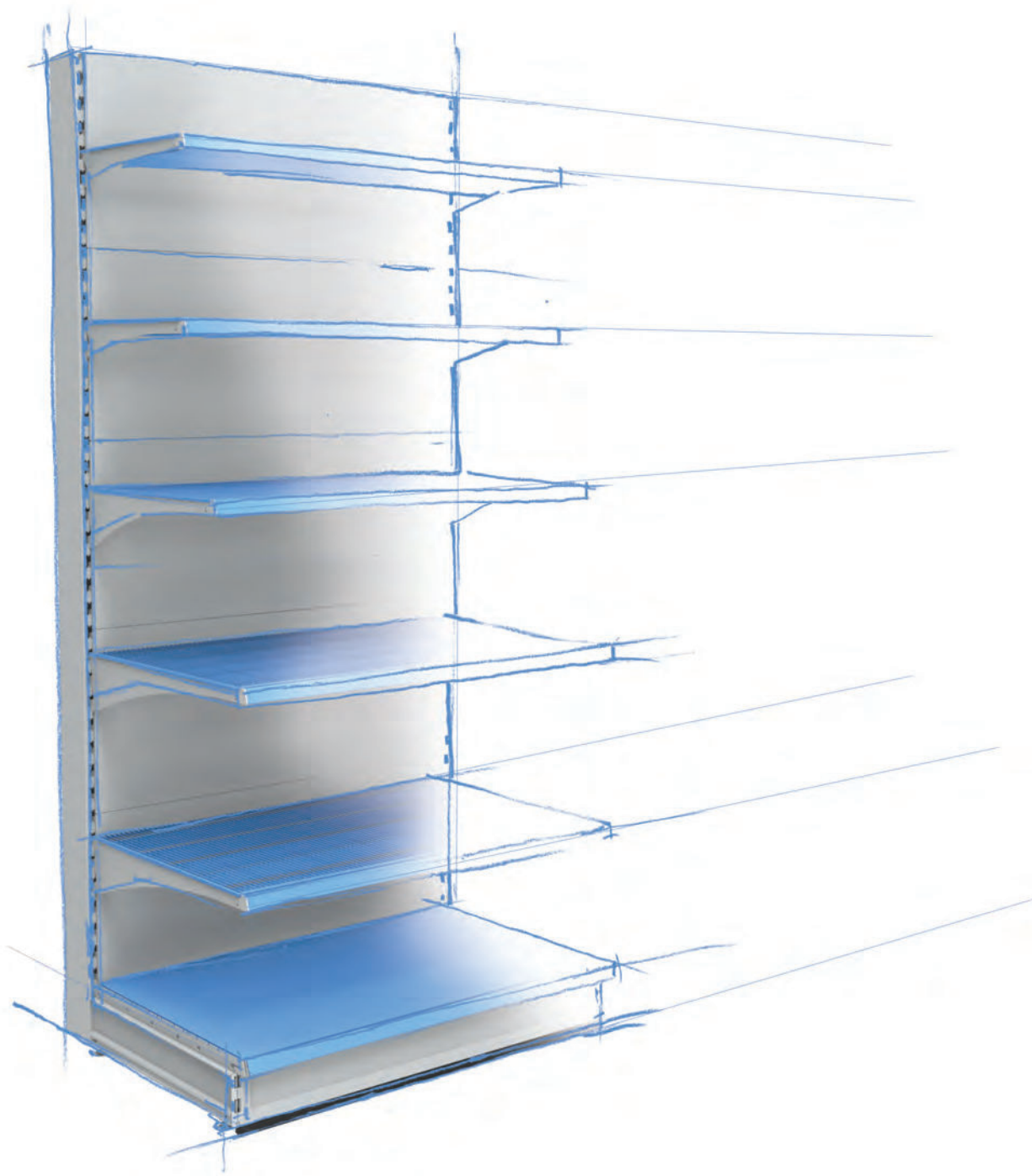

Standard shelving

PL	Spis treści	EN	Contents	FR	Table des matières	DE	Inhaltsverzeichnis	NL	Inhoud
	Wprowadzenie		Introduction		Introduction		Einführung		Introductie
1	Spis treści	1	Contents	1	Table des matières	1	Inhaltsverzeichnis	1	Inhoud
2	Wymiary	2	Dimensions	2	Dimensions	2	Maße	2	Maten
3	Oznaczenia	3	Markings	3	Marquages	3	Kennzeichen	3	Markeringen
4	Prezentacja	4	Presentation	4	Présentation	4	Präsentation	4	Presentatie
	Elementy Bazowe		Base Elements		Éléments de base		Basiselemente		Basiselementen
7	Profile i Stopy	7	Uprights & Baselegs	7	Montants et Pieds	7	Säulen und Fußteile	7	Stijlen en voeten
8	Tyły	8	Back panels	8	Fonds	8	Rückwände	8	Achterwanden
12	Półki i wsporniki	12	Shelves & Brackets	12	Tablettes et Console	12	Fachböden und Konsolen	12	Schappen en consoles
14	Regał - słup dołączany	14	Add-on Shelving	14	Rayon - montant avancé	14	Regal mit Vorstecksäule	14	Voorzetstijlen
18	Dostawki	18	End-Caps	18	Têtes de gondole	18	Kopfregal	18	Plinten en eindakppen
	Akcesoria		Accessories		Accessoires		Zubehör		Accessoires
22	Przegrody i listwy frontowe	22	Dividers & Front Risers	22	Séparateurs et lattes	22	Trenngittern und Frontgitter	22	Schapverdelingen
24	Kosze	24	Baskets	24	Paniers	24	Einhängkörbe	24	Draadmanden
26	Belki i Wieszaki	26	Bars & Hooks	26	Barres et Broches	26	Trageschienen und Halter	25	Draadschappen
30	Wieszaki EURO	30	Hooks EURO	30	Broches EURO	30	Halter EURO	26	Haken
32	Wieszaki PANEL/SW	32	Hooks PANEL/SW	32	Broches FONDS LAMES	32	Halter PANEELE/SW	30	Haken
	Elementy Inne		Other Elements		Autres Eléments		Andere Elemente		Overige elementen
34	Regały narożne	34	Corners	34	Rayons d'angle	34	Eckregale	34	Hoeken
40	Rozwiązania dedykowane	40	Dedicated solutions	40	Solutions dédiées	40	Dedizierte Lösungen	40	Overige oplossingen
42	Ostony	42	Covers & Plinths	42	Caches et plintes	42	Abschlußdeckungen	42	Kappen en plinten
43	Kotwy, inne	43	anchors, others	43	Ancres, autres	43	Montageanker, andere	43	Bevestigingsmateriaal
45	Kolory	45	Colours	45	Couleurs	45	Farben	45	Kleuren

Katalog udostępniany jest bezpłatnie i ma charakter informacyjny - nie jest ofertą handlową w rozumieniu art. 66 §1 KoWdoku Cywilnego. Producent zastrzega sobie prawo dokonywania zmian w specyfikacji technicznej produktu bez uprzedzającej informacji.

The catalogue is free of charge and available for information purposes only - it is not an offer. The manufacturer reserves the right to modify the technical specifications of the product without prior notice.

Le catalogue est gratuit et est créé pour les fins de l'information - il ne constitue pas l'offre commerciale selon la définition de l'art. 66 § 1 du Code Civil. Le producteur se réserve le droit aux modifications de la spécification technique du produit sans l'information préalable.

Das Katalog wird kostenlos zur Verfügung gestellt und hat einen Informationscharakter. Es ist kein Handelsangebot im Sinne von Art. 66 §1 des Bürgerlichen Gesetzbuches. Der Produzent behält sich das Recht auf die Vornahme der Änderungen in der technischen Spezifikation des Produktes ohne vorherige Vorlage der Information vor.

De catalogus is gratis en alleen beschikbaar voor informatie-doeleinden - het is geen aanbod. De fabrikant behoudt zich de recht om de technische specificaties te wijzigen van het product zonder voorafgaande kennisgeving

Wszystkie podane wymiary są nominalne. Jeśli wymagane są dokładne wymiary, proszę skontaktować się z przedstawicielem handlowym firmy Smartline

All dimensions are nominal. If exact dimensions are required, please contact your Smartline repre-sentative.

Les dimensions données sont les dimensions commerciales. Si vous avez besoin d'une dimension exacte, nous vous prions de bien vouloir contacter le représentant commercial de Smartline.

Alle angegebenen Abmessungen sind nominal. Falls genaue Maße erforderlich, bitte einen Smartline Vertreter kontaktieren.

Alle afmetingen zijn nominaal. Als exacte afmetingen zijn vereist, Neem dan contact op met uw Smartline vertegenwoordiger.



Maße Dimensions Wymiary Dimensions

W celu ułatwienia doboru elementów występujących w niniejszym opracowaniu posługujemy się następującym systemem oznaczeń wymiarów:

H – wymiary handlowe w kierunku wysokości regału

D – wymiary handlowe w kierunku głębokości regału

L – wymiary handlowe w kierunku długości regału

Aby ustalić wymiary zewnętrzne lub wewnętrzne elementów należy zapoznać się z rysunkami zawierającymi te informacje odniesione do właściwego wymiaru handlowego lub zwrócić się o wyjaśnienie do Producenta..

In order to make the selection of elements more clearly, we use the indications listed below:

H - rack height „trade” dimensions

D - rack depth „trade” dimensions

L - rack length „trade” dimensions

To determine the external or internal dimensions of the elements, please refer to the drawings containing the information referenced to the appropriate „trade” size or ask the manufacturer to clarify the information.

Afin de faciliter la sélection des éléments présents dans ce catalogue, nous utilisons les indications de dimensions:

H - dimensions du produit dans le sens de la hauteur de la gondole

D - dimensions du produit dans le sens de la profondeur de la gondole

L - Rack Länge Dimensionen

Pour déterminer les dimensions internes ou externes des composants, reportez-vous aux dessins contenant les informations référencées à la taille commerciale appropriée, ou demandez-nous des informations complémentaires.

Um die Auswahl der Elemente aus unserem Folder zu erleichtern, verwenden wir folgende Maßzeichnungen:

H- Abmessung in Richtung Regalhöhe

D- Abmessung in Richtung Regalbreite

L- Abmessung in Richtung Regallänge

Um die innere und äußere Abmessungen der Elemente festzustellen, ist es empfehlenswert, sich mit den Zeichnungen, die die Informationen beinhalten, vertraut zu machen oder den Hersteller danach zu fragen.

Om de selectie te maken van elementen gebruiken we de onderstaande indicaties:

H - afmetingen stellinghoogte "handel".

D - afmetingen van de rekdiepte "handel".

L - afmetingen reklengthe "handel"

Om het externe of interne afmetingen te bepalen van de elementen, raadpleeg de tekeningen met daarin de informatie waarnaar wordt verwezen naar de juiste "handelsgrootte" of vraag de fabrikant om opheldering.

Wszystkie podane wymiary są nominalne. Jeśli wymagane są dokładne wymiary, proszę skontaktować się z przedstawicielem handlowym firmy Smartline

All dimensions are nominal. If exact dimensions are required, please contact your Smartline repre-sentative.

Les dimensions données sont les dimensions commerciales. Si vous avez besoin d'une dimension exacte, nous vous prions de bien vouloir contacter le représentant commercial de Smartline.

Alle angegebenen Abmessungen sind nominal. Falls genaue Maße erforderlich, bitte einen Smartline Vertreter kontaktieren.

Alle afmetingen zijn nominaal. Als exacte afmetingen zijn vereist, neem dan contact op met uw Smartline Vertegenwoordiger

System Standard shelving
25

H- 2100
L- 1000
D- 570

Wire Baskets

1 **POŁKA DRUCIANA** • Wire shelf • Tablette fil
Gitterboden • Плита сетчатая

L	D	Code
665	370	MM-D06370665-00
665	470	MM-D06470665-00
665	570	MM-D06570665-00

1 **FIXED TILTED** • Wire shelf • Tablette fil
Gitterboden • Плита сетчатая

L	D	Code
1000	370	MM-D06371000-00
1000	470	MM-D06471000-00
1000	570	MM-D06571000-00

1 **FIXED TILTED** • Wire shelf • Tablette fil
Gitterboden • Плита сетчатая

L	D	Code
1250	370	MM-D06371250-00
1250	470	MM-D06471250-00
1250	570	MM-D06571250-00

1 **FIXED TILTED** • Wire shelf • Tablette fil
Gitterboden • Плита сетчатая

L	D	Code
1330	370	MM-D06371330-00
1330	470	MM-D06471330-00
1330	570	MM-D06571330-00

2 **LISTWA CENOWA** • Price strip
Prite-diquette • Preisschiene • Ценникдержатель

L	Code
250	ME-C00300250-89

Kennzeichen Marquages Oznaczenia Markings

1
Na wizualizacjach wyróżniono kolorem niebieskim elementy których kody oraz podstawowe wymiary podane zostały w tabelach.

1
On the visualizations the blue colour indicates elements, which codes and dimensions are listed in tables.

1
Sur les visualisations en couleur bleue les éléments dont les codes et les dimensions de base ont été indiquées dans le tableau.

1
In den Visualisierungen wurden blaufarbig Elemente gekennzeichnet, deren Codes und Grundabmessungen in den nachstehenden Tabellen.

1
Op de visualisaties geeft de blauwe kleur de elementen aan, de codes en afmetingen staan vermeld in de tabel.

Wszystkie podane wymiary są nominalne. Jeśli wymagane są dokładne wymiary, proszę skontaktować się z przedstawicielem handlowym firmy Smartline.

All dimensions are nominal. If exact dimensions are required, please contact your Smartline repre-sentative.

Les dimensions données sont les dimensions commerciales. Si vous avez besoin d'une dimension exacte, nous vous prions de bien vouloir contacter le représentant commercial de Smartline.

Alle angegebenen Abmessungen sind nominal. Falls genaue Maße erforderlich, bitte einen Smartline Vertreter kontaktieren.

Alle afmetingen zijn nominaal. Als exacte afmetingen zijn vereist, Neem dan contact op met uw Smartline Vertegenwoordiger.

Twoja szansa na sukces w handlu!

Dużo przestrzeni na towary i otwarte przejścia dla Klientów. Obroty i zyski kontra ograniczone budżety. Bezlitosna walka pomiędzy wizualnymi konceptami i technicznymi oczekiwaniami.

Standard shelving to poczucie przestrzeni premium.

Ekspozowanie zalet Państwa produktów, Standard shelving oddziałuje na emocje klientów, od prostego regału po kompleksową aranżację sklepu.

Podstawowymi słupami wykorzystywanymi w systemie Standard shelving są słupy o przekrojach 30x60mm, 30x80mm oraz 30x110mm dwustronnie perforowane o skoku perforacji 50mm.

Your chance for success in the trade!

Roomy space for goods and open aisles for customers. Turnover & profit vs investment budget cuts. Ruthless battle between visual concepts and technical expectations.

Standard shelving ensures a sense of premium interiors highlights advantages of your products Standard shelving stimulates customers' emotions, from simple shelving to the complex arrangement of the store.

Main cross-section of Uprights used in Standard shelving are 30 x 60mm, 30 x 80mm and 30 x 110mm two side perforated with perforation pitch 50.

C'est ta chance pour le succès du commerce!

Un grand espace pour les produits ainsi que des vastes couloirs pour les clients. Le Chiffre d'affaires et les bénéfices par rapport aux budgets limités.

Standard shelving c'est un sentiment d'espace de luxe. Exposition des avantages de vos produits, Standard shelving influence les émotions des clients, du simple rayon au complexe aménagement du magasin.

Les montants standards utilisés dans le système Standard shelving sont de section: 30x60mm, 30x80mm ainsi que 30x110mm bilatéralement perforés, perforation 50mm.

Standard shelving ist ein premium Raum-gefühl hebt die Vorteile Ihrer Produkte hervor, Standard shelving bewegt die Gemüter, vom einfachen Regal bis zur komplexen Ladenausstattung.

Standardquerschnitt von Säulen im System Standard shelving 30x60mm, 30x80mm und 30x110mm, zweiseitig gelocht mit 50mm Schlitzung

Jouw kans op succes in de handel

Veel ruimte voor goederen en open gangpaden voor klanten. Afzet & winst versus bezuinigingen op investeringsbudgetten. Meedogenloze strijd tussen visuele concepten en technische verwachtingen.

Standaard winkelstellingen zorgen voor een gevoel voor premium interieur en benadrukt de voordelen van uw producten. Standaard winkelstellingen stimuleert de emoties van klanten, van eenvoudige rekken tot complexe inrichting van de winkel.

De maatvoering van de staanders gebruikt in standaard rekken is 30 x 60 mm, 30 x 80 mm en 30 x 110 mm, tweezijdig geperforeerd met een perforatiesteek van 50.

Standard shelving

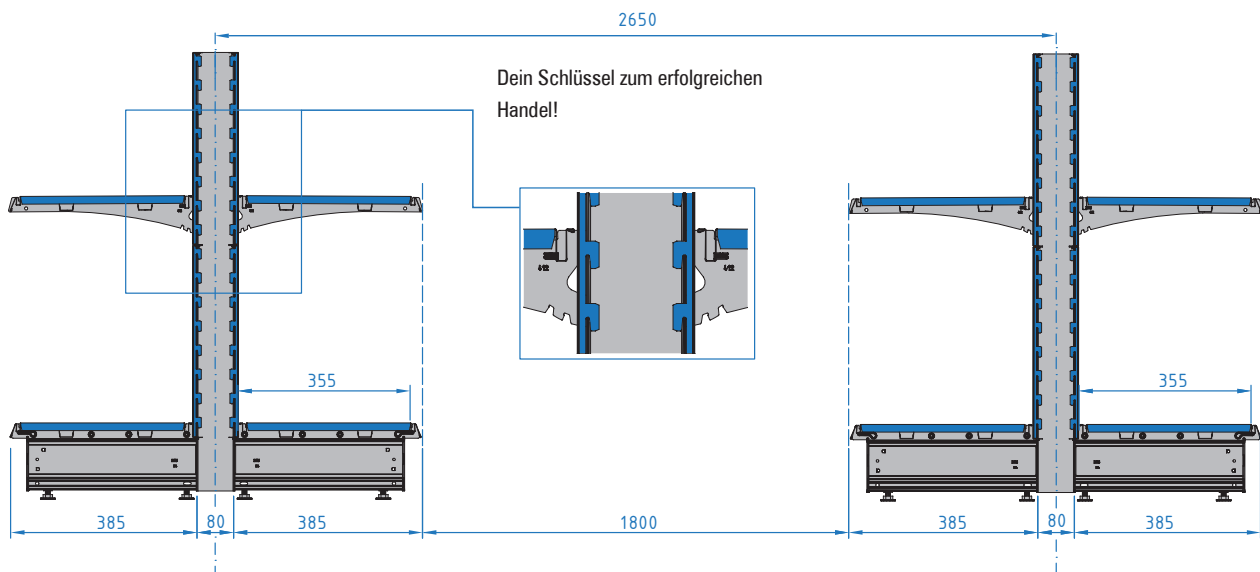

Wszystkie podane wymiary są nominalne. Jeśli wymagane są dokładne wymiary, proszę skontaktować się z przedstawicielem handlowym firmy Smartline

All dimensions are nominal. If exact dimensions are required, please contact your Smartline repre-sentative.

Les dimensions données sont les dimensions commerciales. Si vous avez besoin d'une dimension exacte, nous vous prions de bien vouloir contacter le représentant commercial de Smartline.

Alle angegebenen Abmessungen sind nominal. Falls genaue Messe erforderlich, bitte einen Smartline Vertreter kontaktieren.

Alle afmetingen zijn nominaal. Als exacte afmetingen zijn vereist, neem dan contact op met uw Smartline Vertegenwoordiger.

W systemie Standard shelving standardowe wymiary półki to 370mm,470mm, 570mm. Proponowane szerokości regałów,dające możliwość optymalnego wykorzystania przestrzeni sprzedażowej sklepów to 665, 1000, 1250 oraz 1330mm.

Standard shelving standard shelves dimensions are 370mm, 470mm, 570mm. Proposed shelving bays widths providing optimal usage of stores selling space are 665, 1000, 1250 and 1330mm.

Les dimensions standards des tablettes utilisées dans le système Standard shelving sont 370mm, 470mm, 570mm. Les largeurs proposées des rayons 665,1000,1250 et 1330mm offrent la possibilité de l'utilisation optimale de l'espace du magasin.

Für optimale Nutzung von Verkaufsf lächen sind die Standardgrößen von Fachbden die Tiefen 370, 470, 570 und die Längen 665mm, 1000mm, 1250mm, 1330mm.

Standaard afmetingen; de afmetingen van de legborden zijn 370 mm, 470 mm, 570 mm. Standaard breedtemaat 665, 1000, 1250 en 1330mm.

Stopa podstawowa systemu Standard shelving ma wysokość 160mm i służy do budowania standardowych regałów oraz dostawek i regałów ze słupkami dołączanymi.

Baseleg of Standard shelving system height is 160mm and is used to build standard shelvings as well as shelving with add-on profiles and end-caps.

Le pied standard du système Standard shelving est de la hauteur 160mm et sert construire de rayons standards ainsi que les ttes de gondoles avec les montants rajoutés.

Das Fußteil im Standard shelving 60mm und wird bei Standardregalen, Kopfregealen und Regalen mit einer Frontsäule verwendet.

Voet van standaard rekken; systeemhoogte is 160mm en is gebruikt om standaard rekken te bouwen evenals rekken met aanbouw profielen en eindkappen.

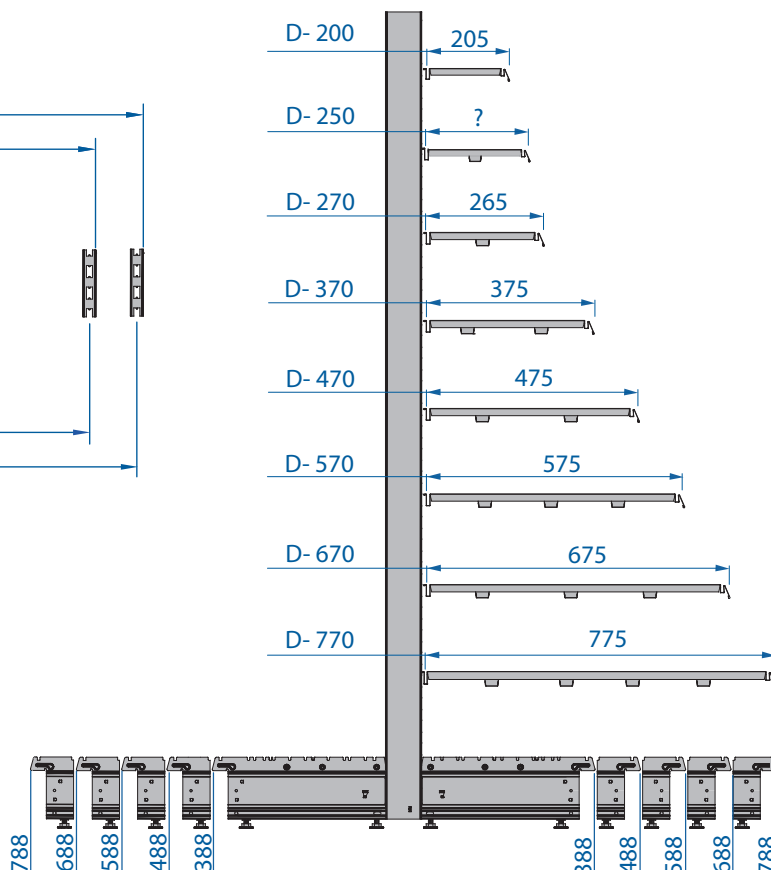
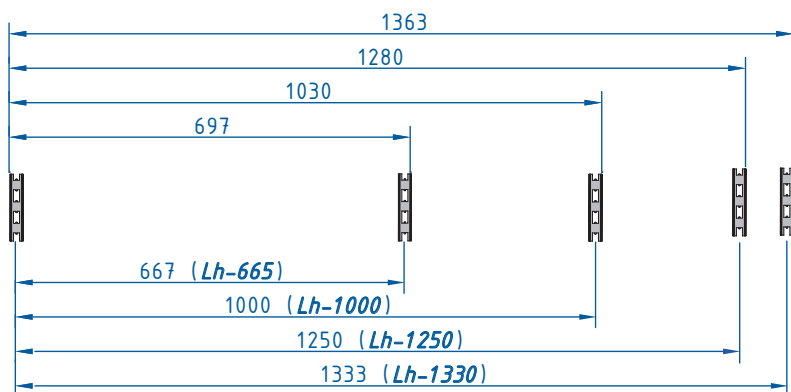



Basiselemente
Éléments de base
Base elements
Elementy bazowe

H- 2100

L- 1000

D-570

Uprights & Base-legs

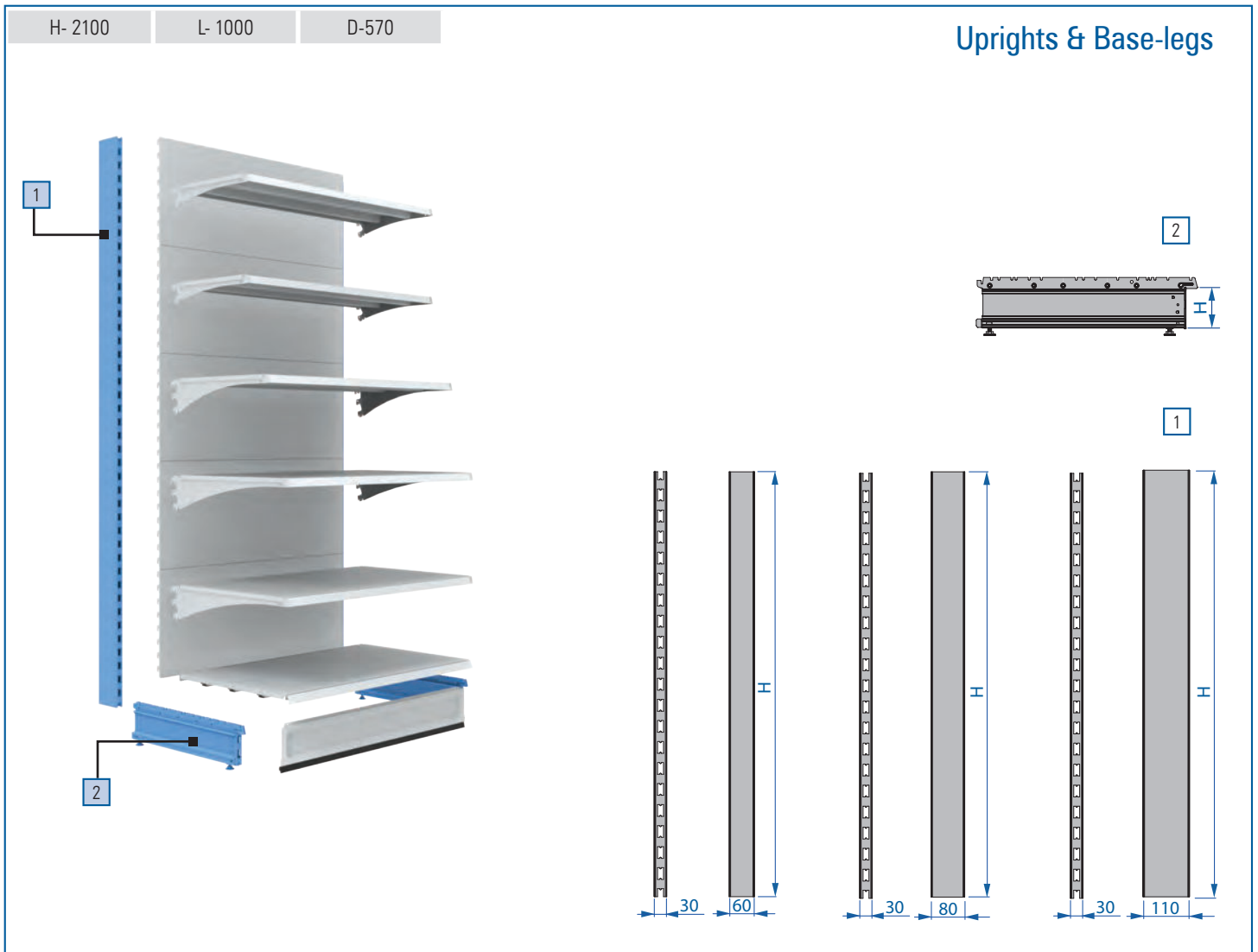

1 60 × 30
Slup • Upright • Montant • Säule • Stijl

H	Code
1400	TE-N07006140-00
1600	TE-N07006160-00
1800	TE-N07006180-00
2000	TE-N07006200-00
2100	TE-N07006210-00
2200	TE-N07006220-00
2400	TE-N07006240-00
2600	TE-N07006260-00
2800	TE-N07006280-00
3000	TE-N07006300-00

1 80 × 30
Slup • Upright • Montant • Säule • Stijl

H	Code
1400	TE-N07008140-00
1600	TE-N07008160-00
1800	TE-N07008180-00
2000	TE-N07008200-00
2100	TE-N07008210-00
2200	TE-N07008220-00
2400	TE-N07008240-00
2600	TE-N07008260-00
2800	TE-N07008280-00
3000	TE-N07008300-00

1 110 × 30
Slup • Upright • Montant • Säule • Stijl

H	Code
1800	TE-N07011180-00
2000	TE-N07011200-00
2200	TE-N07011220-00
2400	TE-N07011240-00

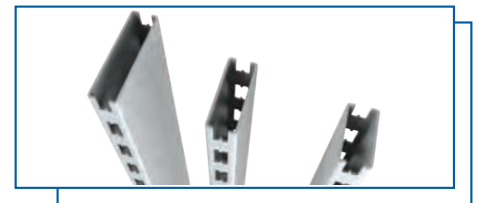

2 H - 160
Stopa • Baseleg • Pied • Fußteil • Voet

H	Code
370	TE-N96337011-00
470	TE-N96347011-00
570	TE-N96357011-00
670	TE-N96367011-00
770	TE-N96377011-00



H- 1600

L- 1000

D-570

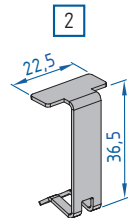
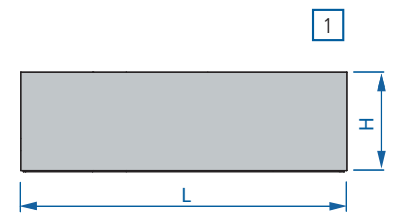
Back panels
Plain

1 PLAIN
 Tyły • Back panels • Fond • Rückwände • Glad

L	H	Code
600	100	TE-T20100600-00
600	200	TE-T20200600-00
600	300	TE-T20300600-00
600	400	TE-T20400600-00
600	500	TE-T20500600-00

665	100	TE-T20100665-00
665	200	TE-T20200665-00
665	300	TE-T20300665-00
665	400	TE-T20400665-00
665	500	TE-T20500665-00

800	100	TE-T20100800-00
800	200	TE-T20200800-00
800	300	TE-T20300800-00
800	400	TE-T20400800-00
800	500	TE-T20500800-00

1 PLAIN
 Tyły • Back panels • Fond • Rückwände • Glad

L	H	Code
1000	100	TE-T20101000-00
1000	200	TE-T20201000-00
1000	300	TE-T20301000-00
1000	400	TE-T20401000-00
1000	500	TE-T20501000-00

1250	100	TE-T20101250-00
1250	200	TE-T20201250-00
1250	300	TE-T20301250-00
1250	400	TE-T20401250-00
1250	500	TE-T20501250-00

1330	100	TE-T20101330-00
1330	200	TE-T20201330-00
1330	300	TE-T20301330-00
1330	400	TE-T20401330-00
1330	500	TE-T20501330-00

2 P50 • Zabezpieczenie • Safety lock • Antidécrochement de fond • Sicherung • Zekering

Code
ME-A05070050-50

H- 1700

L- 1000

D-570

**Back panels
EURO Perforated**

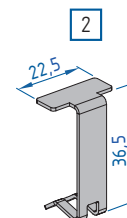
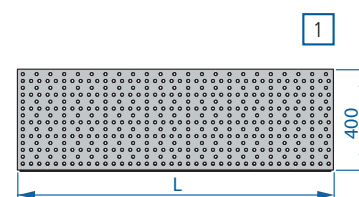
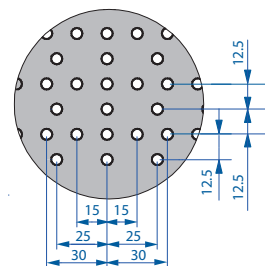
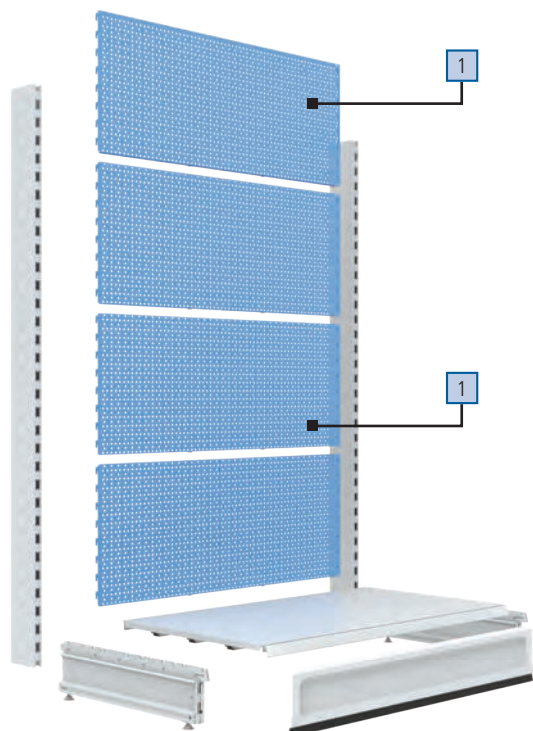

1 EURO
Tily • Back panels • Fonds • Rückwände • Perfoachterwand

L	H	Code
665	400	TE-T21400665-00
1000	400	TE-T21401000-00
1250	400	TE-T21401250-00
1330	400	TE-T21401330-00

2 P50 • Zabezpieczenie • Safety lock • Antidécrochement de fond • Sicherung • Zekering

Code
ME-A05070050-50

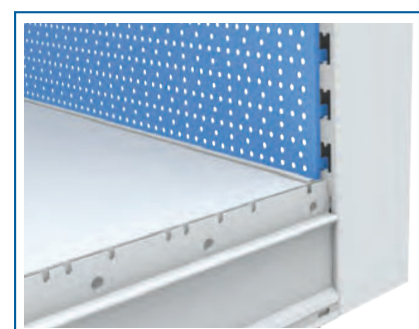
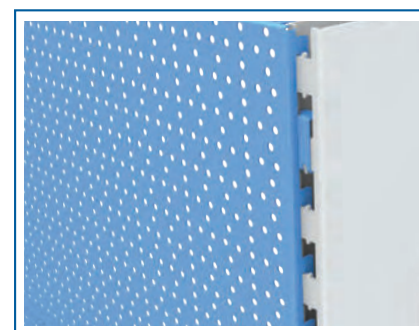

H- 1700

L- 1000

D-570

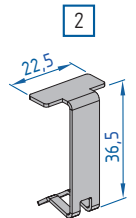
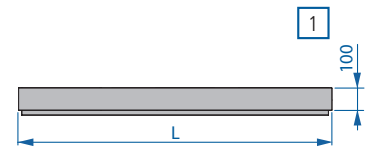
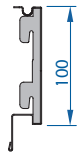
Back panels
Panel

1 **PANEL** • Tyły • Back panels • Fonds • Rückwände
• Lamellen achterwand

L	H	Code
665	100	MP-T54100665-00
1000	100	MP-T54101000-00
1250	100	MP-T54101250-00
1330	100	MP-T54101330-00

2 **P50** • Zabezpieczenie • Safety lock
Antidécrochement de fond • Sicherung • Zekering

Code
ME-A05070050-50





H- 2100

L- 1000

D-470

Shelves & Brackets

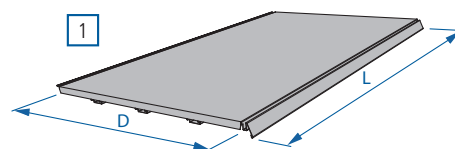
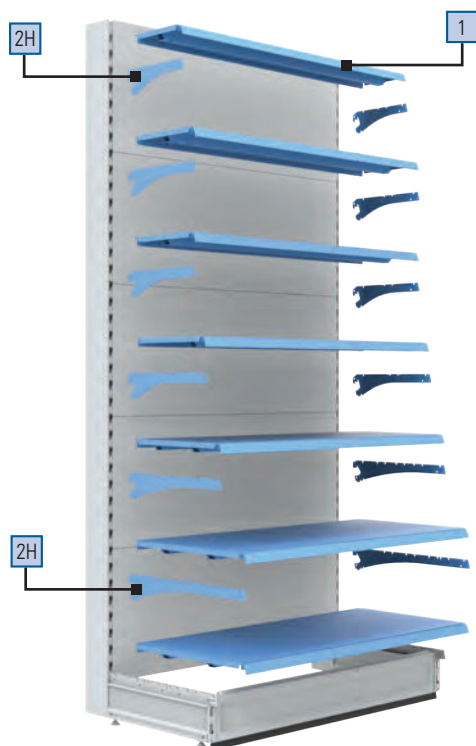

D - 200

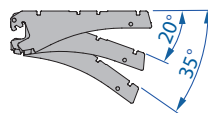

2H

D - 300

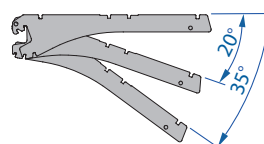

D - 250

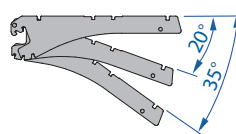

D - 370

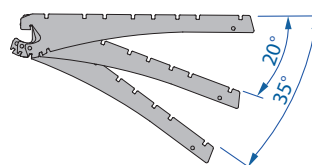

D - 270

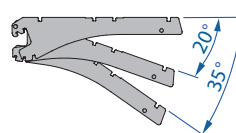

D - 470

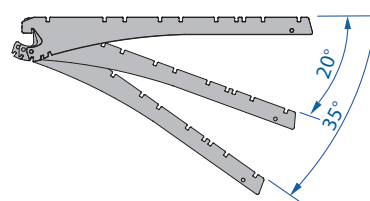
1 CLASSIC
 Półka • Shelf • Tablette • Fachboden • Schap

L	D	Reinforcements	Code
600	200	1	NE-P00200600-00
600	250	1	NE-P00250600-00
600	270	1	NE-P00270600-00
600	300	1	NE-P00300600-00
600	370	2	NE-P00370600-00
600	470	2	NE-P00470600-00
665	200	1	NE-P00200665-00
665	250	1	NE-P00250665-00
665	270	1	NE-P00270665-00
665	300	1	NE-P00300665-00
665	370	2	NE-P00370665-00
665	470	2	NE-P00470665-00
800	200	1	NE-P00200800-00
800	250	1	NE-P00250800-00
800	270	1	NE-P00270800-00
800	300	1	NE-P00300800-00
800	370	2	NE-P00370800-00
800	470	2	NE-P00470800-00

1 CLASSIC
 Półka • Shelf • Tablette • Fachboden • Schap

L	D	Reinforcements	Code
1000	200	1	NE-P00201000-00
1000	250	1	NE-P00251000-00
1000	270	1	NE-P00271000-00
1000	300	1	NE-P00301000-00
1000	370	2	NE-P00371000-00
1000	470	2	NE-P00471000-00
1250	200	1	NE-P00201250-00
1250	250	1	NE-P00251250-00
1250	270	1	NE-P00271250-00
1250	300	1	NE-P00301250-00
1250	370	2	NE-P00371250-00
1250	470	3	NE-P00471250-00
1330	200	1	NE-P00201330-00
1330	250	1	NE-P00251330-00
1330	270	1	NE-P00271330-00
1330	300	1	NE-P00301330-00
1330	370	2	NE-P00371330-00
1330	470	3	NE-P00471330-00

2H ADJUSTABLE
 Wspornik • Bracket • Console • Konsole • Console

D	Code
200	ME-W10010200-00
250	ME-W10010250-00
270	ME-W10010270-00
300	ME-W10010300-00
370	ME-W10010370-00
470	ME-W12240470-00

H- 2100

L- 1000

D-770

Shelves & Brackets

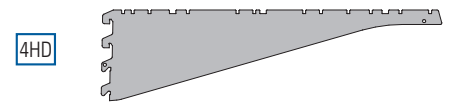
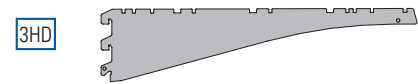
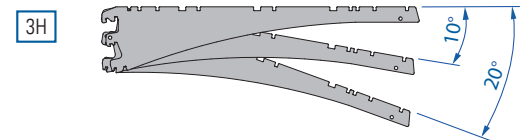
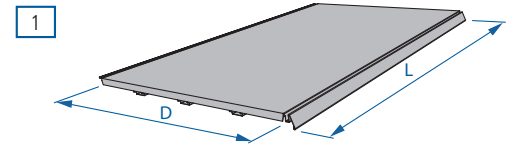
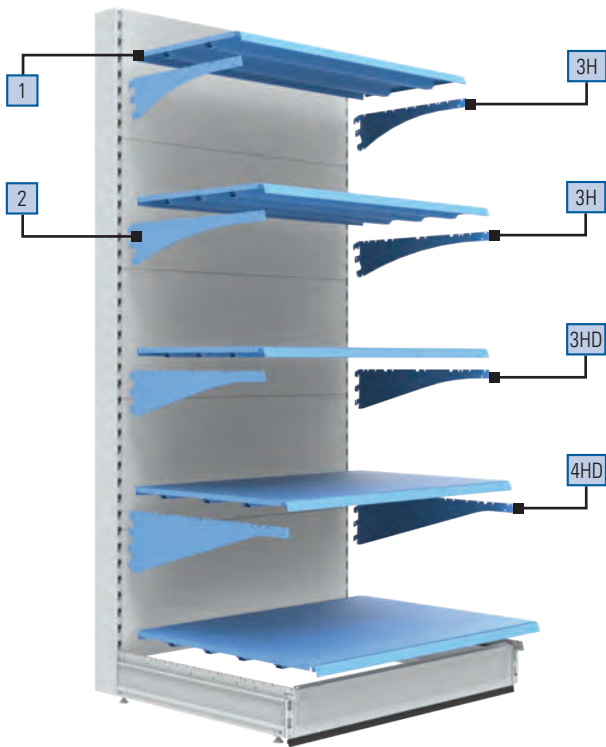

1 CLASSIC			
Półka • Shelf • Tablette • Fachboden • Schap			
L	D	Reinforcements	Code
600	470	2	NE-P00470600-00
600	570	3	NE-P00570600-00
600	670	3	NE-P00670600-00
600	770	4	NE-P00770600-00
665	470	2	NE-P00470665-00
665	570	3	NE-P00570665-00
665	670	3	NE-P00670665-00
665	770	4	NE-P00770665-00
800	470	2	NE-P00470800-00
800	570	3	NE-P00570800-00
800	670	3	NE-P00670800-00
800	770	4	NE-P00770800-00

1 CLASSIC			
Półka • Shelf • Tablette • Fachboden • Schap			
L	D	Reinforcements	Code
1000	470	2	NE-P00471000-00
1000	570	3	NE-P00571000-00
1000	670	3	NE-P00671000-00
1000	770	4	NE-P00771000-00
1250	470	3	NE-P00471250-00
1250	570	3	NE-P00571250-00
1250	670	3	NE-P00671250-00
1250	770	4	NE-P00771250-00
1330	470	3	NE-P00471330-00
1330	570	3	NE-P00571330-00
1330	670	3	NE-P00671330-00
1330	770	4	NE-P00771330-00

3H ADJUSTABLE	
Wspornik • Bracket • Console • Konsole • Console	
D	Code
470	ME-W10010470-00
570	ME-W10010570-00

3HD STRAIGHT	
Wspornik • Bracket • Console • Konsole • Console	
D	Code
470	ME-W10030470-00
570	ME-W10030570-00
670	ME-W10030670-00

4HD STRAIGHT	
Wspornik • Bracket • Console • Konsole • Console	
D	Code
570	ME-W10020570-00
670	ME-W10020670-00
770	ME-W10020770-00

H- 2100

L- 1330

D-570

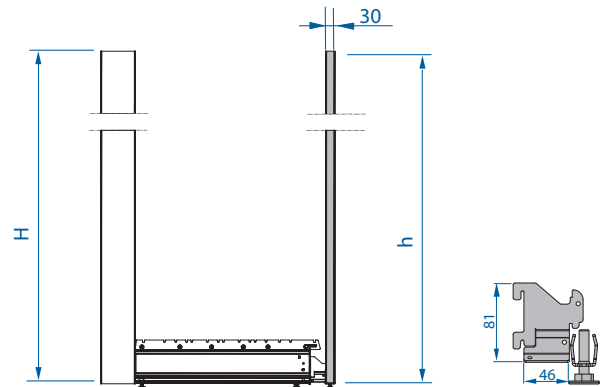
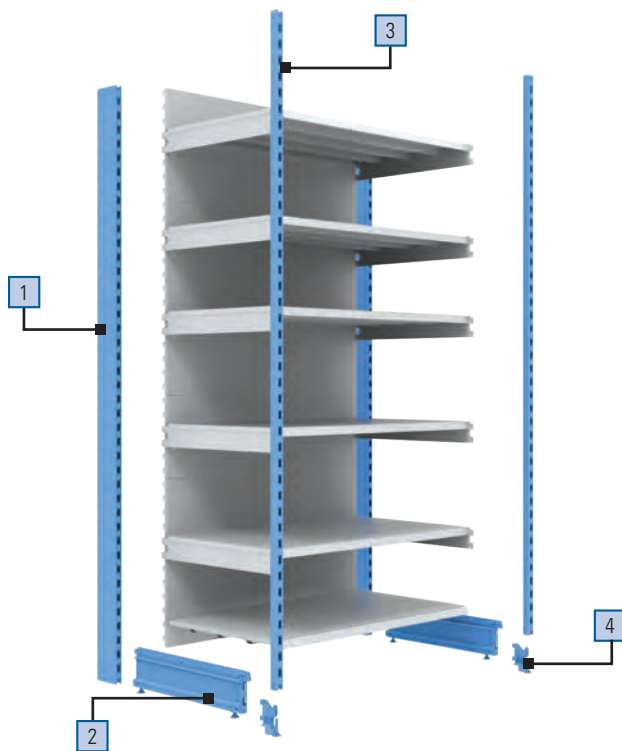
Uprights & Base-legs
Add-on ONE

1 60 × 30
 Slup • Add-on upright • Montant • Säule • Voorzetstijlen

H	Code
1100	TE-N07006110-00
1200	TE-N07006120-00
1400	TE-N07006140-00
1600	TE-N07006160-00
1800	TE-N07006180-00
2000	TE-N07006200-00
2100	TE-N07006210-00
2200	TE-N07006220-00
2400	TE-N07006240-00
2600	TE-N07006260-00
2800	TE-N07006280-00
3000	TE-N07006300-00

1 110 × 30
 Slup • Add-on upright • Montant • Säule • Voorzetstijlen

H	Code
1800	TE-N07011180-00
2000	TE-N07011200-00
2200	TE-N07011220-00
2400	TE-N07011240-00

1 80 × 30
 Slup • Add-on upright • Montant • Säule • Voorzetstijlen

H	Code
1400	TE-N07008140-00
1600	TE-N07008160-00
1800	TE-N07008180-00
2000	TE-N07008200-00
2100	TE-N07008210-00
2200	TE-N07008220-00
2400	TE-N07008240-00
2600	TE-N07008260-00
2800	TE-N07008280-00
3000	TE-N07008300-00

2 H - 160
 Stopa • Baseleg • Pied • Fußteil • Voet

D	Code
370	TE-N96337011-00
470	TE-N96347011-00
570	TE-N96357011-00
670	TE-N96367011-00
770	TE-N96377011-00

3 FRONT 30 × 30
 Slup • Add-on upright • Montant • Säule • Voorzetstijlen

H	h	Code
1300	1300	TE-N07003130-00
1400	1400	TE-N07003140-00
1500	1500	TE-N07003150-00
1600	1600	TE-N07003160-00
1700	1700	TE-N07003170-00
1800	1800	TE-N07003180-00
1900	1900	TE-N07003190-00
2000	2000	TE-N07003200-00
2100	2100	TE-N07003210-00
2200	2200	TE-N07003220-00
2300	2300	TE-N07003230-00
2400	2400	TE-N07003240-00
2500	2500	TE-N07003250-00
2600	2600	TE-N07003260-00
3000	3000	TE-N07003300-00

4 Adapter • Adapter • Adapteur • Adapter • Adapter

Code	
46x93	TE-A01000046-00

H- 2100

L- 1330

D-570

Shelves & Brackets
Add-on ONE

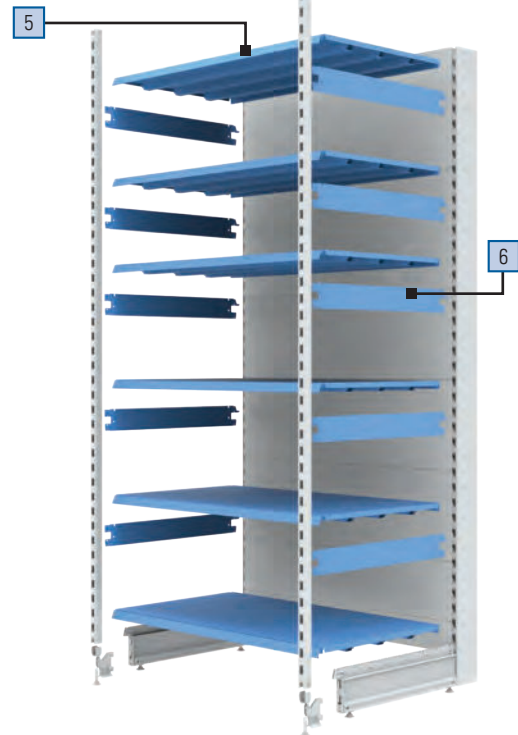
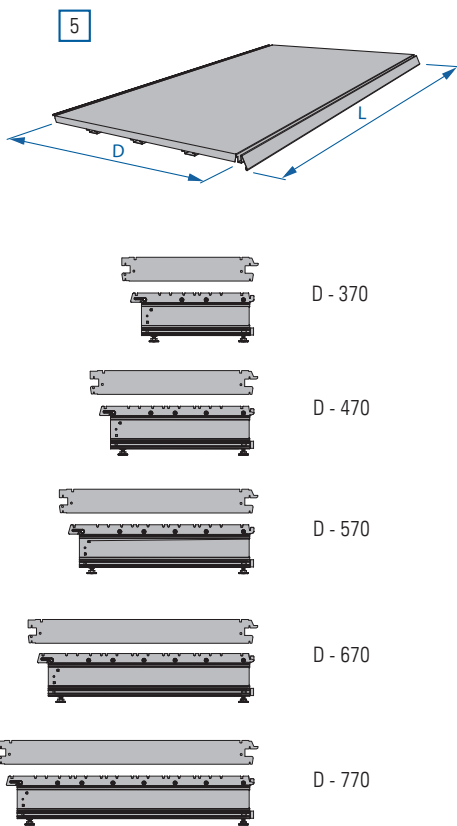

5 CLASSIC
Półka • Shelf • Tablette • Fachboden • Schap

L	D	Reinforcements	Code
600	370	2	NE-P00370600-00
600	470	2	NE-P00470600-00
600	570	3	NE-P00570600-00
600	670	3	NE-P00670600-00
600	770	4	NE-P00770600-00
665	370	2	NE-P00370665-00
665	470	2	NE-P00470665-00
665	570	3	NE-P00570665-00
665	670	3	NE-P00670665-00
665	770	4	NE-P00770665-00
800	370	2	NE-P00370800-00
800	470	2	NE-P00470800-00
800	570	3	NE-P00570800-00
800	670	3	NE-P00670800-00
800	770	4	NE-P00770800-00

5 CLASSIC
Półka • Shelf • Tablette • Fachboden • Schap

L	D	Reinforcements	Code
1000	370	2	NE-P00371000-00
1000	470	2	NE-P00471000-00
1000	570	3	NE-P00571000-00
1000	670	3	NE-P00671000-00
1000	770	4	NE-P00771000-00
1250	370	2	NE-P00371250-00
1250	470	3	NE-P00471250-00
1250	570	3	NE-P00571250-00
1250	670	3	NE-P00671250-00
1250	770	4	NE-P00771250-00
1330	370	2	NE-P00371330-00
1330	470	3	NE-P00471330-00
1330	570	3	NE-P00571330-00
1330	670	3	NE-P00671330-00
1330	770	4	NE-P00771330-00

6 SINGLE BEARER • Wspornik obustronny • Two-sided bracket
Console bilatérale • Konsole beidseitig • Console dubbelzijdig

D	Code
370	TE-W04030370-00
470	TE-W04030470-00
570	TE-W04030570-00
670	TE-W04030670-00
770	TE-W04030770-00

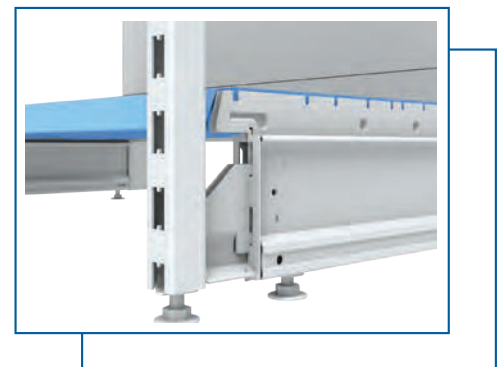

H- 2100

L- 1330

D-570

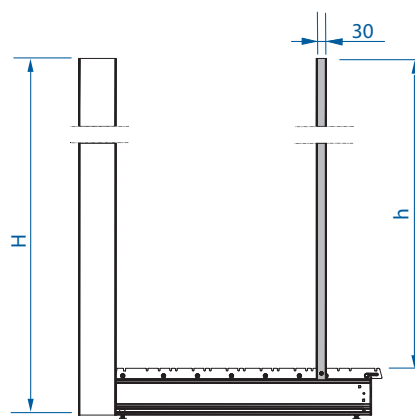
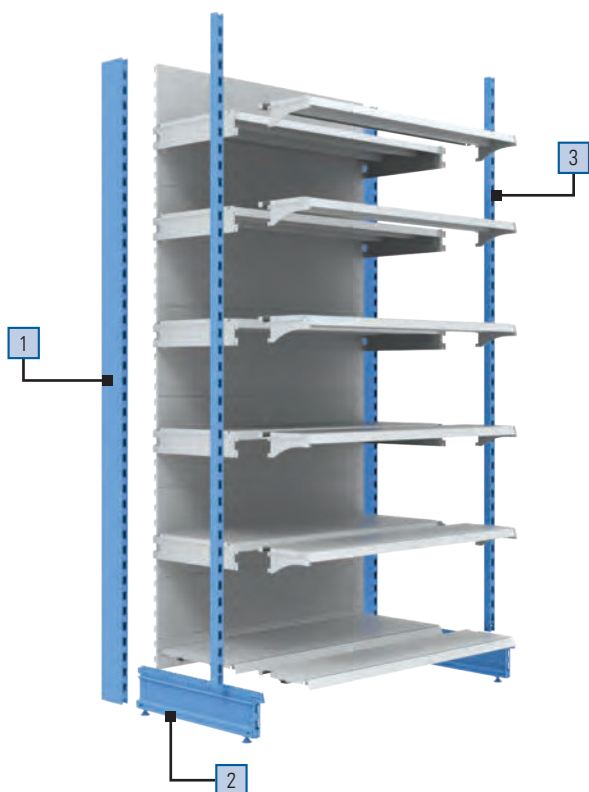
Uprights & Base-legs
Add-on TWO

1 60 × 30
Stup • Add-on upright • Montant • Säule • Stijl

H	Code
1100	TE-N07006110-00
1200	TE-N07006120-00
1400	TE-N07006140-00
1600	TE-N07006160-00
1800	TE-N07006180-00
2000	TE-N07006200-00
2100	TE-N07006210-00
2200	TE-N07006220-00
2400	TE-N07006240-00
2600	TE-N07006260-00
2800	TE-N07006280-00
3000	TE-N07006300-00

1 110 × 30
Stup • Add-on upright • Montant • Säule • Stijl

H	Code
1800	TE-N07011180-00
2000	TE-N07011200-00
2200	TE-N07011220-00
2400	TE-N07011240-00

1 80 × 30
Stup • Add-on upright • Montant • Säule • Stijl

H	Code
1400	TE-N07008140-00
1600	TE-N07008160-00
1800	TE-N07008180-00
2000	TE-N07008200-00
2100	TE-N07008210-00
2200	TE-N07008220-00
2400	TE-N07008240-00
2600	TE-N07008260-00
2800	TE-N07008280-00
3000	TE-N07008300-00

2 H - 160
Stopa • Baseleg • Pied • Fußteil • Voet

D	Code
370	TE-N96337011-00
470	TE-N96347011-00
570	TE-N96357011-00
670	TE-N96367011-00
770	TE-N96377011-00

3 FRONT 30 × 30
Stup • Add-on upright • Montant • Säule • Voorzetstijl

H	h	Code
1300	1200	TE-N40600120-00
1400	1300	TE-N40600130-00
1500	1400	TE-N40600140-00
1600	1500	TE-N40600150-00
1700	1600	TE-N40600160-00
1800	1700	TE-N40600170-00
1900	1800	TE-N40600180-00
2000	1900	TE-N40600190-00
2100	2000	TE-N40600200-00
2200	2100	TE-N40600210-00
2300	2200	TE-N40600220-00
2400	2300	TE-N40600230-00
2500	2400	TE-N40600240-00
2600	2500	TE-N40600250-00
2700	2600	TE-N40600260-00
3100	3000	TE-N40600300-00

H- 2100

L- 1330

D-570

Shelves & Brackets
Add-on TWO

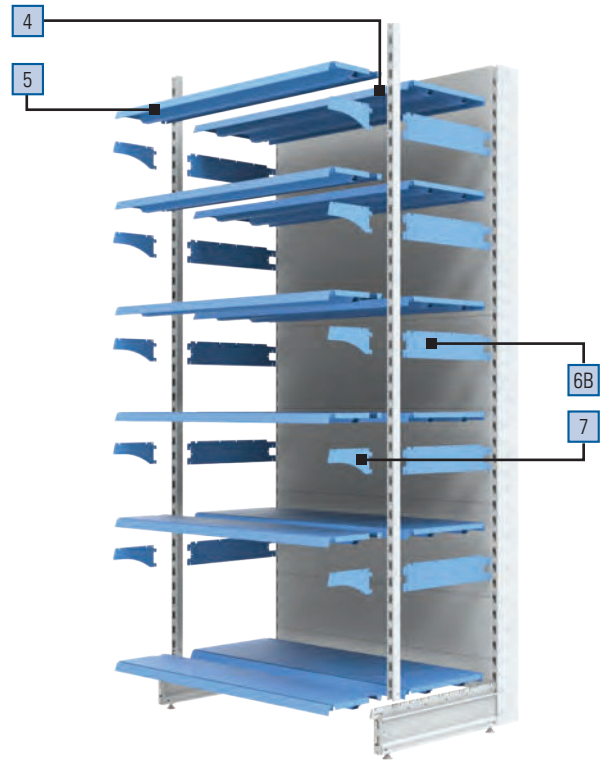
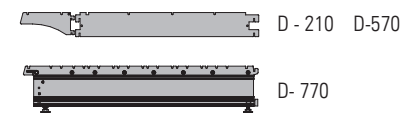
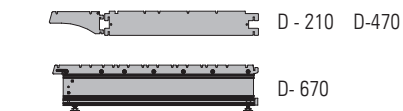
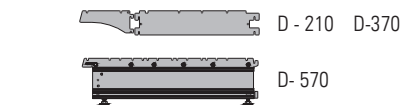
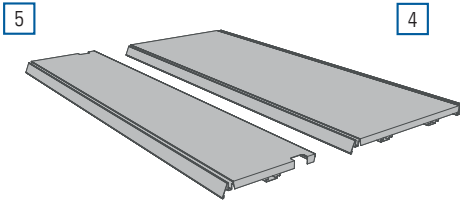

4 CLASSIC
Półka • Shelf • Tablette • Fachboden • Schap

L	D	Reinforcements	Code
600	370	2	NE-P00370600-00
600	470	2	NE-P00470600-00
600	570	3	NE-P00570600-00
665	370	2	NE-P00370665-00
665	470	2	NE-P00470665-00
665	570	3	NE-P00570665-00
800	370	2	NE-P00370800-00
800	470	2	NE-P00470800-00
800	570	3	NE-P00570800-00

5 ADD-ON • Półka dołączana • Add-on shelf • Tablette avancée • Erweiterungsfachboden • Voorzetbodem

L	D	Code
600	210	NE-P61210600-00
665	210	NE-P61210665-00
800	210	NE-P61210800-00
1000	210	NE-P61211000-00
1250	210	NE-P61211250-00
1330	210	NE-P61211330-00

4 CLASSIC
Półka • Shelf • Tablette • Fachboden • Schap

L	D	Reinforcements	Code
1000	370	2	NE-P00371000-00
1000	470	2	NE-P00471000-00
1000	570	3	NE-P00571000-00
1250	370	2	NE-P00371250-00
1250	470	3	NE-P00471250-00
1250	570	3	NE-P00571250-00
1330	370	2	NE-P00371330-00
1330	470	3	NE-P00471330-00
1330	570	3	NE-P00571330-00

7 ADD-ON • Wspornik • Add-on bracket
Console avancée • Erweiterungskonsole • Voorzet console

	Code
210	CE-W10290150-00

6b SINGLE BEARER • Wspornik obustronny • Two-sided bracket
Console bilatérale • Konsole beidseitig • Console dubbelzijdig

D	Code
370	ME-W00430390-00
470	ME-W00430470-00
570	ME-W00430570-00

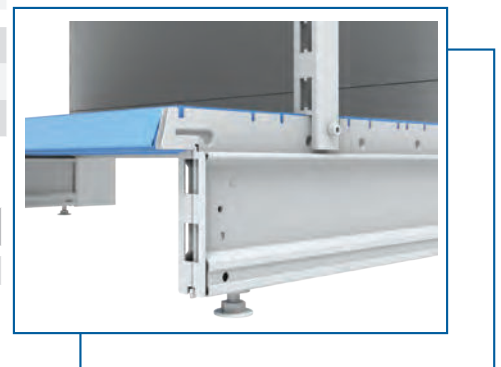

End-Caps
 Back panels, Shelves & Plinths

H- 1700 L- 1000 D-570 (End cap)

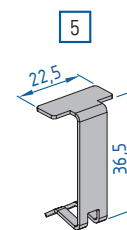
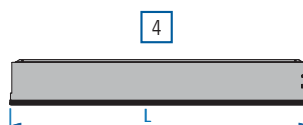
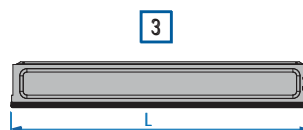
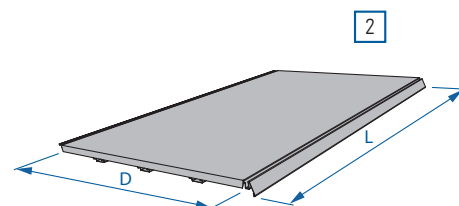
1 PLAIN
 Tyły • Back panels • Fonds • Rückwände • Achterwand

L	H	Code
600	200	TE-T20200600-00
600	300	TE-T20300600-00
600	400	TE-T20400600-00
800	200	TE-T20200800-00
800	300	TE-T20300800-00
800	400	TE-T20400800-00
1000	200	TE-T20201000-00
1000	300	TE-T20301000-00
1000	400	TE-T20401000-00
1200	200	TE-T20201200-00*
1200	300	TE-T20301200-00*
1200	400	TE-T20401200-00*

2 CLASSIC
 Półka • Shelf • Tablette • Fachboden • Schap

L	D1	D2	Codez
600	370	270	NE-P00370600-00
600	470	270	NE-P00470600-00
600	570	270	NE-P00570600-00
800	370	370	NE-P00370800-00
800	470	370	NE-P00470800-00
800	570	370	NE-P00570800-00
1000	370	470	NE-P00371000-00
1000	470	470	NE-P00471000-00
1000	570	470	NE-P00571000-00
1200	370	570	NE-P00371200-00
1200	470	570	NE-P00471200-00
1200	570	570	NE-P00571200-00

3 DE
 Oslona dolna • Plinth • Plinthe • Sockelblende • Plint

L	Code
600	OS-D71150600-00
665	OS-D71150665-00
800	OS-D71150800-00
1000	OS-D71151000-00
1250	OS-D71151250-00
1330	OS-D71151330-00

5 P50 • Zabezpieczenie • Safety lock Antidécrochement de fond • Sicherung • Zekering

Code
ME-A05070050-50

4 UK
 Oslona dolna • Plinth • Plinthe • Sockelblende • Plint

L	Code
600	OS-D73150600-00
665	OS-D73150665-00
800	OS-D73150800-00
1000	OS-D73151000-00
1200	OS-D73151200-00
1250	OS-D73151250-00
1330	OS-D73151330-00

End-Caps
Uprights, Connectors, Tie Bars & Accessories

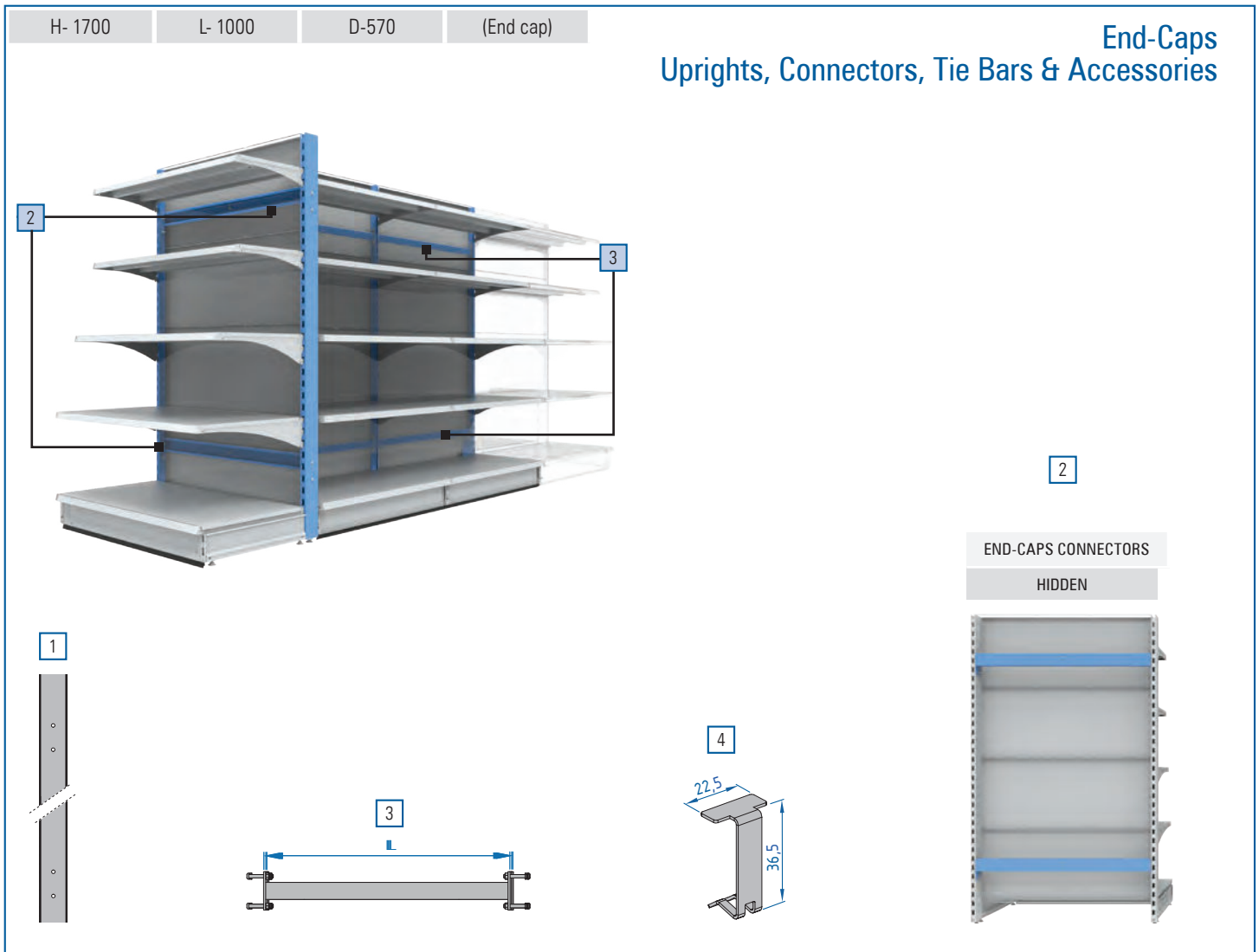

1 60 x 30 DRILLED
Slup • Add-on upright • Montant • Säule • Stijl met boorgaten

H	Code
1100	TE-N17006110-00
1200	TE-N17006120-00
1400	TE-N17006140-00
1600	TE-N17006160-00
1800	TE-N17006180-00
2000	TE-N17006200-00
2100	TE-N17006210-00
2200	TE-N17006220-00

1 80 x 30 DRILLED
Slup • Add-on upright • Montant • Säule • Stijl met boorgaten

H	Code
1400	TE-N17008140-00
1600	TE-N17008160-00
1800	TE-N17008180-00
2000	TE-N17008200-00
2100	TE-N17008210-00
2200	TE-N17008220-00

2 CONNECTOR HIDDEN
Łącznik dostawki • End-Cap Connector • Barre de fixation TG
Verbindung für Kopfregal • Eindkap connector

L	Code
600	TE-B01020600-00
800	TE-B01020800-00
1000	TE-B01021000-00
1200	TE-B01021200-00

3 TIE BAR (required gondola reinforcement) • Belka Bar • Barre de renfort • Verstärkung • Verstevigingsprofiel

L	Code
600	TE-B00020600-00
665	TE-B00020665-00
800	TE-B00020800-00
1000	TE-B00021000-00
1250	TE-B00021250-00
1330	TE-B00021330-00

4 P50 • Zabezpieczenie • Safety lock • Antidécrochement de fond • Sicherung • Zekering

Code
ME-A05070050-50

Accessories Zubehör
Akcesoria
Accessoires



H- 2100

L- 1000

D-570

Accessories

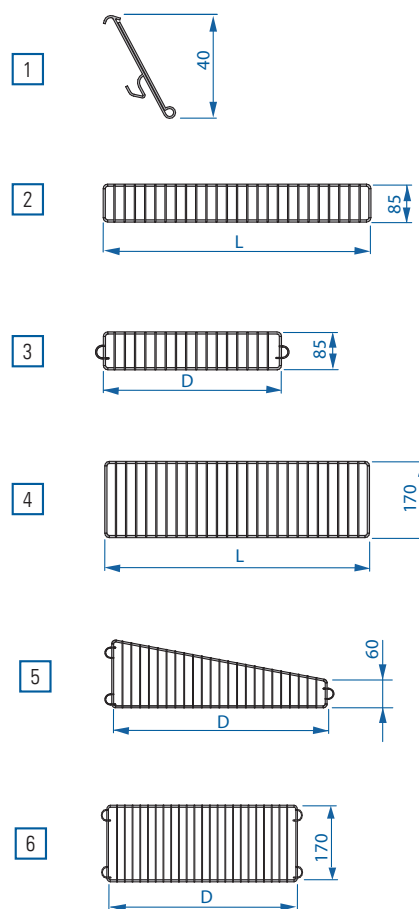
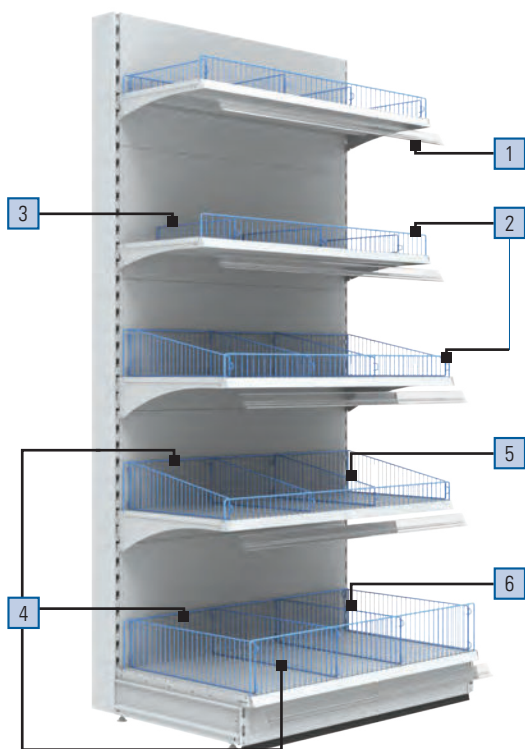

1 CLEAR • Listwa cenowa • Price strip
Porte-étiquette • Preisschiene • Prijsrail

D	Code
600	ME-C00100600-89
665	ME-C00100665-89
800	ME-C00100800-89
1000	ME-C00101000-89
1250	ME-C00101250-89
1330	ME-C00101330-89

2 WIRE H-85 • Listwa druciana • Wire strip
Latte il • Frontgitter • Voorrooster

L	Code
600	ME-L00010600-00
665	ME-L00010665-00
800	ME-L00010800-00
1000	ME-L00011000-00
1250	ME-L00011250-00
1330	ME-L00011330-00

3 WIRE H-85 • Przegroda • Divider Séparateur •
Trenngitter • Separatierooster

D	Code
370	ME-D00010370-00
470	ME-D00010470-00
570	ME-D00010570-00

4 WIRE H-170 • Listwa druciana • Wire
strip Latte il • Frontgitter • Voorrooster

L	Code
600	ME-L00050600-00
665	ME-L00050665-00
800	ME-L00050800-00
1000	ME-L00051000-00
1250	ME-L00051250-00
1330	ME-L00051330-00

5 WIRE H-170 • Przegroda • Divider Séparateur • Trenngitter •
Separatierooster

D	Code
370	ME-D00100370-00
470	ME-D00100470-00
570	ME-D00100570-00

6 WIRE H-170 • Przegroda h-170 • Divider
Séparateur • Trenngitter • Separatierooster

D	Code
370	ME-D00040370-00
470	ME-D00040470-00
570	ME-D00040570-00



H- 2100

L- 1000

D-570

Accessories

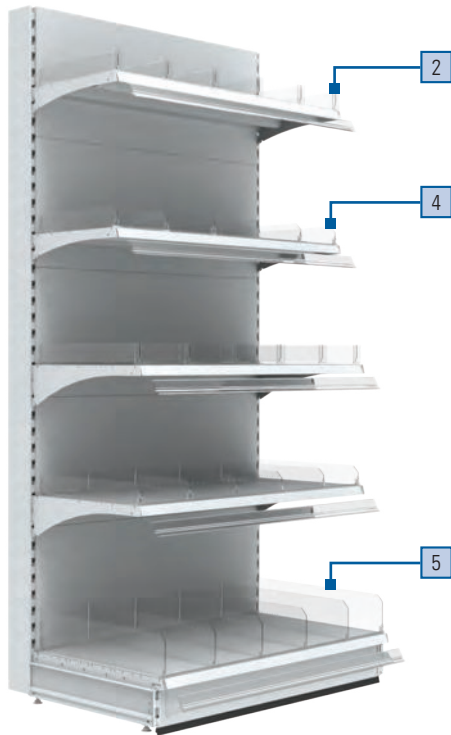

1

OPTION 1
PUSH-IN

◀ SELECT ▶

OPTION 2
GLUE

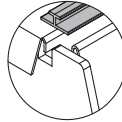
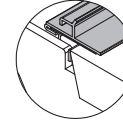
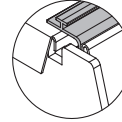
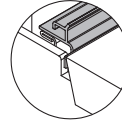

2

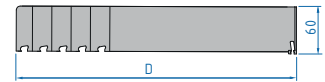

3



4

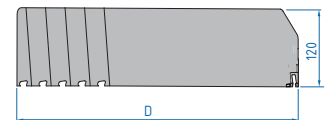

1 PUSH IN

Listwa • Slat • Latte • Leiste • Separatie

L	Rear	Front
1000	ME-L01071000-89	ME-L01061000-89
1250	ME-L01071250-89	ME-L01061250-89
1330	ME-L01071330-89	ME-L01061330-89

◀ SELECT ▶

1 GLUE

Listwa • Slat • Latte • Leiste • Separatie

L	Rear	tt
1000	ME-L01081000-89	ME-L01091000-89
1250	ME-L01081250-89	ME-L01091250-89
1330	ME-L01081330-89	ME-L01091330-89

2 H-60 CLEAR • Przegroda T

Divider T • Séparateur T • Trenngitter T • Separatie

D	Code
270	ME-D01050270-89
370	ME-D01050370-89
470	ME-D01050470-89
570	ME-D01050570-89

3 H-60 CLEAR

Przegroda • Divider • Séparateur • Trenngitter • Separatie

D	Code
270	ME-D01020270-89
370	ME-D01020370-89
470	ME-D01020470-89
570	ME-D01020570-89

4 H-120 CLEAR

Przegroda • Divider • Séparateur • Trenngitter • Separatie

D	Code
370	ME-D01080370-89
470	ME-D01080470-89
570	ME-D01080570-89

H- 2100

L- 1000

D-570

Wire Baskets

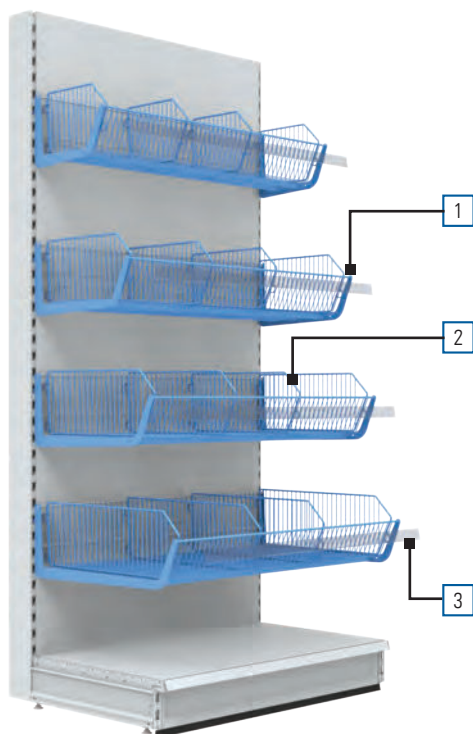

1

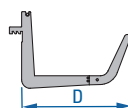

2

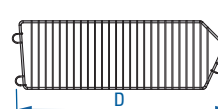
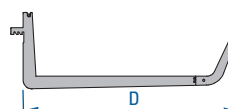
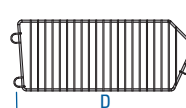
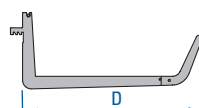
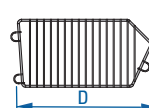
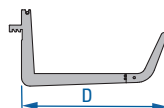
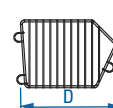

3



1

Kosz • Basket
Panier suspendu • Einhängkorb • Inhangmand

L	D	Code
600	270	ME-K68270600-00
600	370	ME-K68370600-00
600	470	ME-K68470600-00
600	570	ME-K68570600-00
665	270	ME-K68270665-00
665	370	ME-K68370665-00
665	470	ME-K68470665-00
665	570	ME-K68570665-00
800	270	ME-K68270800-00
800	370	ME-K68370800-00
800	470	ME-K68470800-00
800	570	ME-K68570800-00

1

Kosz • Basket
Panier suspendu • Einhängkorb • Inhangmand

L	D	Code
1000	270	ME-K68271000-00
1000	370	ME-K68371000-00
1000	470	ME-K68471000-00
1000	570	ME-K68571000-00
1250	270	ME-K68271250-00
1250	370	ME-K68371250-00
1250	470	ME-K68471250-00
1250	570	ME-K68571250-00
1330	270	ME-K68271330-00
1330	370	ME-K68371330-00
1330	470	ME-K68471330-00
1330	570	ME-K68571330-00

2

Przegroda •
Divider • Séparateur • Trenngitter • Separatie

D	Code
270	ME-D00290270-00
370	ME-D00290370-00
470	ME-D00290470-00
570	ME-D00290570-00

3

Listwa cenowa • Price strip
Porte-étiquette • Preisschiene • Prijsrail

L	Code
600	ME-C00300600-89
665	ME-C00300655-89
800	ME-C00300800-89
1000	ME-C00300990-89
1250	ME-C00301240-89
1330	ME-C00301320-89

H- 2100

L- 1000

D-570

Wire Baskets



1 PÓŁKA DRUCIANA • Wire shelf • Tablette fil
Gitterboden • Draadschap

L	D	Code
665	370	MM-D06370665-00
665	470	MM-D06470665-00
665	570	MM-D06570665-00

1 PÓŁKA DRUCIANA • Wire shelf • Tablette fil
Gitterboden • Draadschap

L	D	Code
1000	370	MM-D06371000-00
1000	470	MM-D06471000-00
1000	570	MM-D06571000-00

1 PÓŁKA DRUCIANA • Wire shelf • Tablette fil
Gitterboden • Draadschap

L	D	Code
1250	370	MM-D06371250-00
1250	470	MM-D06471250-00
1250	570	MM-D06571250-00

1 PÓŁKA DRUCIANA • Wire shelf • Tablette fil
Gitterboden • Draadschap

L	D	Code
1330	370	MM-D06371330-00
1330	470	MM-D06471330-00
1330	570	MM-D06571330-00

2 Listwa cenowa • Price strip
Porte-étiquette • Preisschiene • Prijsrail

L	Code
250	ME-C00300250-89

H- 2100

L- 1000

D-570

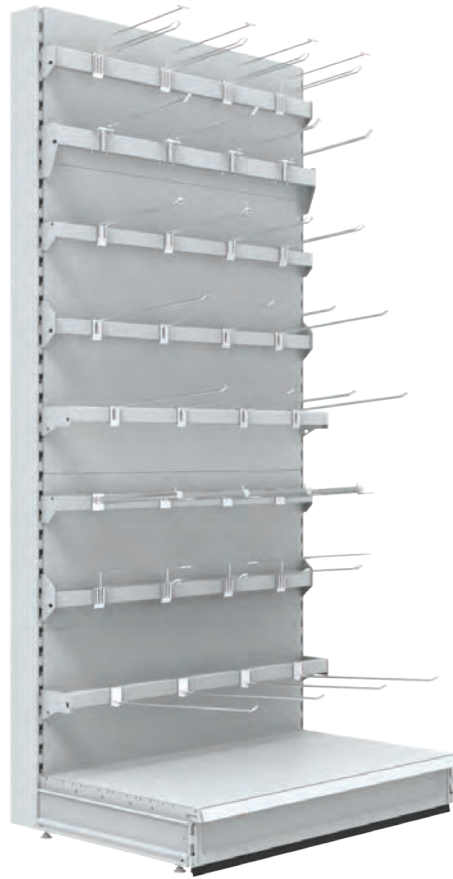
Bars & Hooks

H- 2100

L- 1000 (3x)

D-570



Bars & Hooks

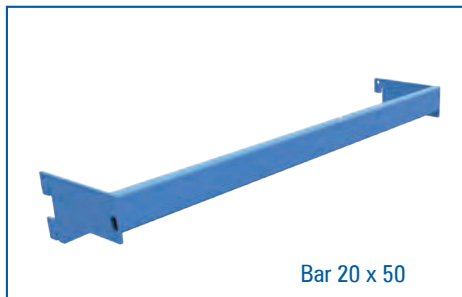

Bar 20 x 50

1 Belka • Bar • Barre • Trageschiene • Draagbalk

L	Code
665	ME-B00640665-00
1000	ME-B00641000-00
1250	ME-B00641250-00
1330	ME-B00641330-00

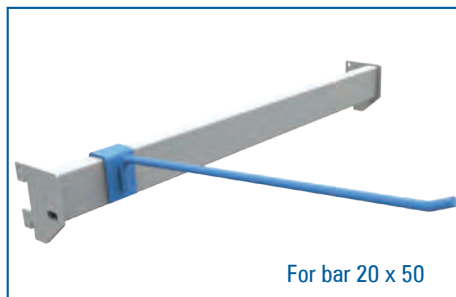

For bar 20 x 50

2 Wieszak • Hook • Broche • Halter • Haak

∅	D	Code
6	300	WB-A38206300-00
6	400	WB-A38206400-00
8	300	WB-A38208300-00
8	400	WB-A38208400-00

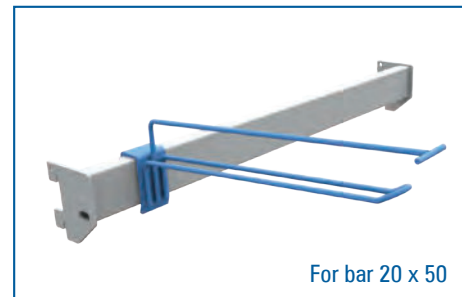

For bar 20 x 50

3 Wieszak • Hook • Broche • Halter • Haak

∅	D	Code
6	400	WB-A65706400-00

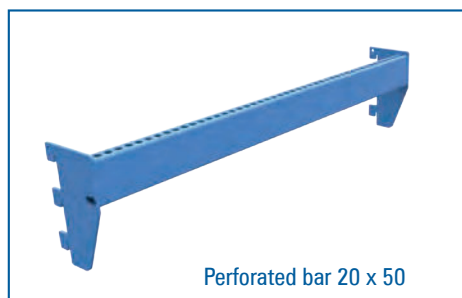

Perforated bar 20 x 50

4 Belka Perforowana • Bar Perforated
Barre Perforée • Trageschiene Gelocht • Draagbalk met gaten

L	Code
665	ME-B02150665-00
1000	ME-B02151000-00
1250	ME-B02151250-00
1330	ME-B02151330-00

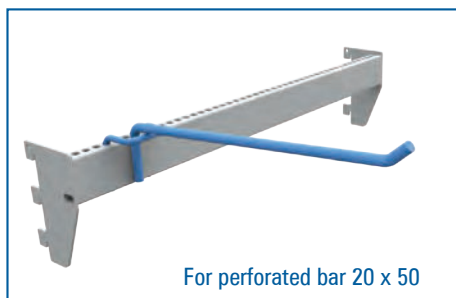

For perforated bar 20 x 50

5 Wieszak • Hook • Broche • Halter • Haak

∅	D	Code
10	200	WB-P03510200-00
10	300	WB-P03510300-00
10	400	WB-P03510400-00

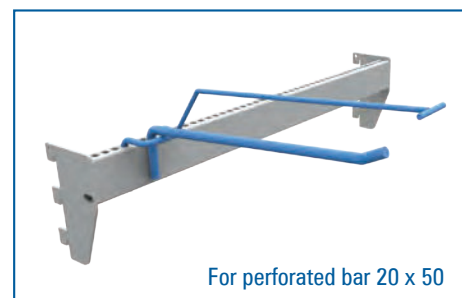

For perforated bar 20 x 50

6 Wieszak • Hook • Broche • Halter • Haak

∅	D	Code
6	400	WB-P03606400-00
10	200	WB-P03610200-00
10	300	WB-P03610300-00
10	400	WB-P03610400-00

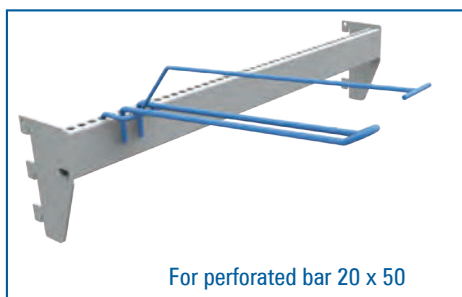

For perforated bar 20 x 50

7 Wieszak • Hook • Broche • Halter • Haak

∅	D	Code
6	200	WB-P00906200-00
6	400	WB-P00906400-00
10	300	WB-P00910300-00
10	400	WB-P00910400-00

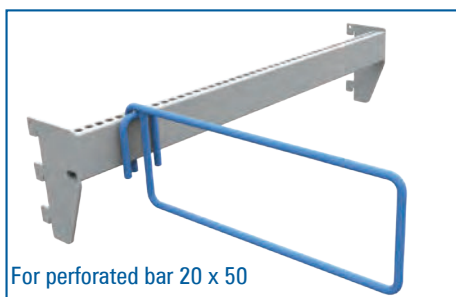

For perforated bar 20 x 50

2d Wieszak • Hook • Broche • Halter • Raamhaak

D	Code
200	WB-P06208200-00
300	WB-P06208300-00
400	WB-P06208400-00

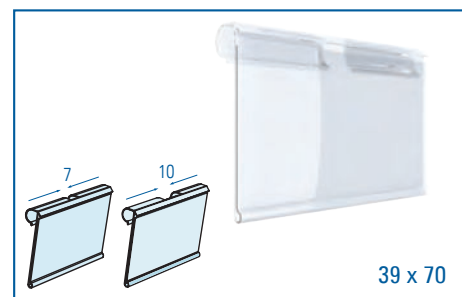

39 x 70

Etykieta wahliva przezroczysta • Clear swing ticket • Porte-étiquette en PVC Transparent • Etikettentasche transparent • Etiketten enveloppe

∅	Code
5 / 6 / 7	WA-E00000101
8 / 10	WA-E00000108

Bars & Hooks

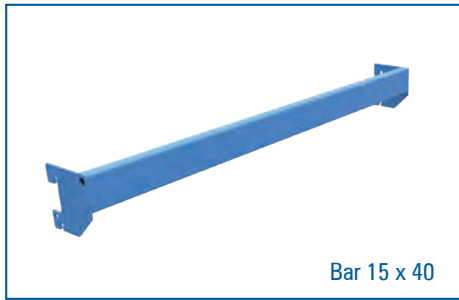

1 Belka • Bar • Barre • Trageschiene • Draagbalk

L	Code
665	ME-B00050665-00
1000	ME-B00051000-00
1250	ME-B00051250-00
1330	ME-B00051330-00

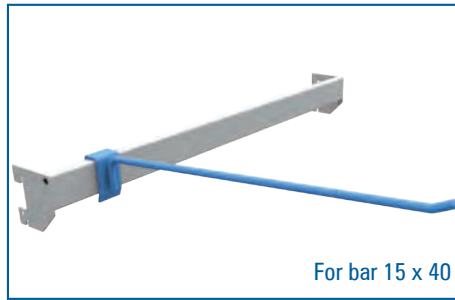

2 Wieszak • Hook • Broche • Halter • Haak

∅	D	Code
6	200	WB-A36406200-00
6	300	WB-A36406300-00
6	400	WB-A36406400-00

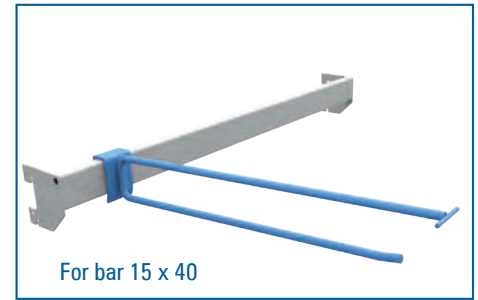

3 Wieszak • Hook • Broche • Halter • Haak

∅	D	Code
6	200	WB-A36806200-00
6	300	WB-A36806300-00
8	400	WB-A36808400-00
8	500	WB-A36808500-00

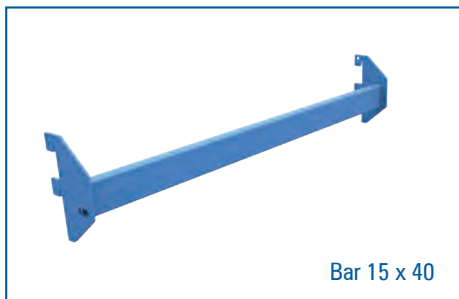

4 Belka • Bar • Barre • Trageschiene • Draagbalk

L	Code
665	ME-B00570665-00
1000	ME-B00571000-00
1250	ME-B00571250-00
1330	ME-B00571330-00

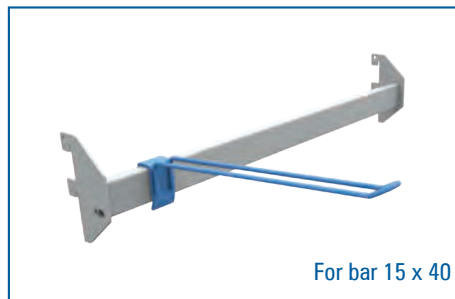

5 Wieszak • Hook • Broche • Halter • Kledinghaak

∅	D	Code
5	100	WB-A38805100-00
5	200	WB-A38805200-00
5	300	WB-A38805300-00



6 Wieszak • Hook • Broche • Halter • Haak

∅	D	Code
20	300	WB-A07120300-00
20	400	WB-A07120400-00
20	500	WB-A07120500-00

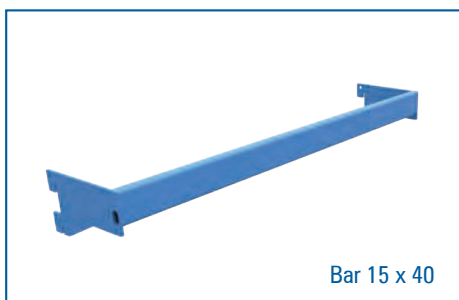

7 Belka • Bar • Barre • Trageschiene • Draagbalk

L	Code
665	ME-B00660665-00
1000	ME-B00661000-00
1250	ME-B00661250-00
1330	ME-B00661330-00

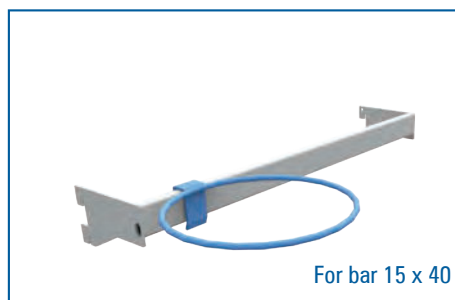

8 Belka • Bar • Barre • Trageschiene • Emmerhaak

Diameter	D	Code
210	215	WB-A79607215-00

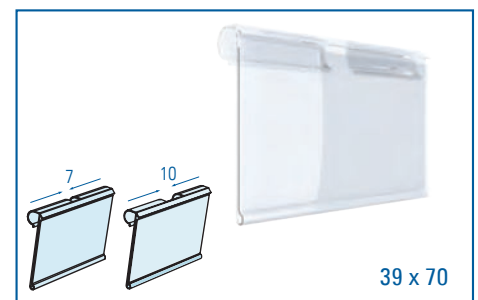

Etykieta wahliva przezroczysta • Clear swing ticket • Porte-étiquette en PVC Transparent • Etikettentasche transparent • Etiketten enveloppe

∅	Code
5 / 6 / 7	WA-E00000101
8 / 10	WA-E00000108

Bars & Hooks

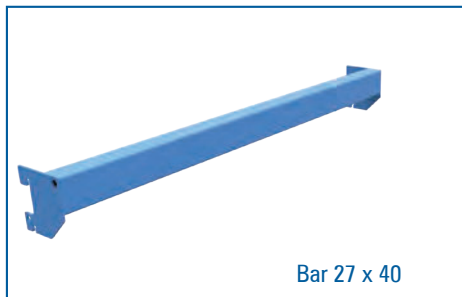

1 Belka • Bar • Barre • Trageschiene • Draagbalk

L	Code
665	ME-B00010665-00
1000	ME-B00011000-00
1250	ME-B00011250-00
1330	ME-B00011330-00

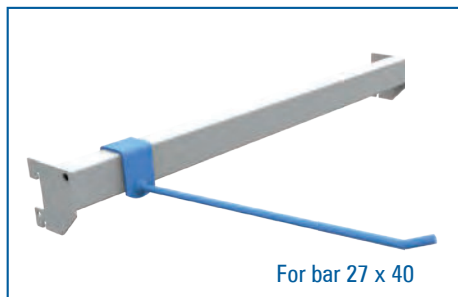

2 Wieszak • Hook • Broche • Halter • Haak

∅	D	Code
6	200	WB-A02106200-00
6	300	WB-A02106300-00
8	400	WB-A02108400-00
8	500	WB-A02108500-00

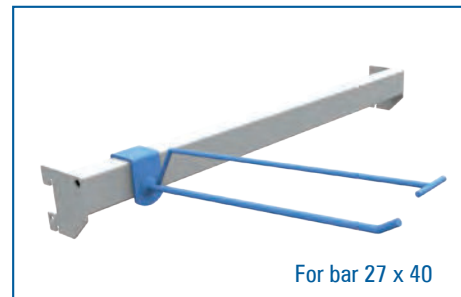

3 Wieszak • Hook • Broche • Halter • Haak

∅	D	Code
6	200	WB-A02406200-00
6	300	WB-A02406300-00
8	400	WB-A02408400-00
8	500	WB-A02408500-00

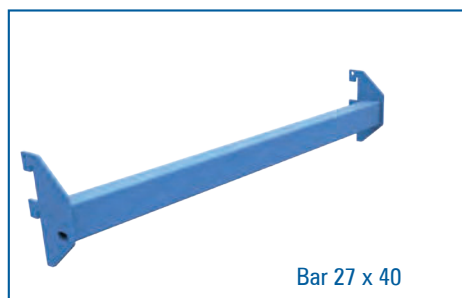

4 Belka • Bar • Barre • Trageschiene • Draagbalk

L	Code
665	ME-B00590665-00
1000	ME-B00591000-00
1250	ME-B00591250-00
1330	ME-B00591330-00

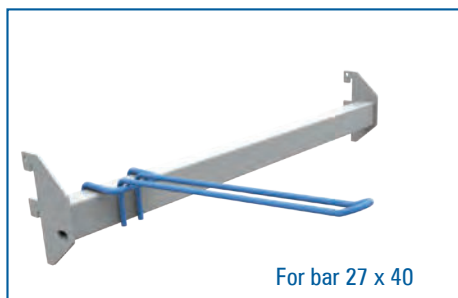

5 Wieszak • Hook • Broche • Halter • Haak

∅	D	Code
5	200	WB-A00205200-00

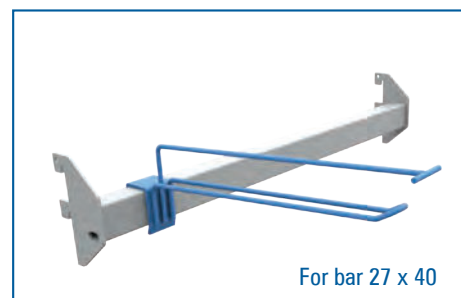

6 Wieszak • Hook • Broche • Halter • Haak

∅	D	Code
6	300	WB-A00706300-00
6	400	WB-A00706400-00
8	450	WB-A00708450-00

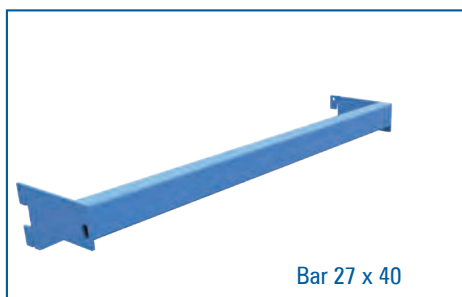

7 27 x 40 • Belka
Bar • Barre • Trageschiene •

L	Code-
665	ME-B00710665-00
1000	ME-B00711000-00
1250	ME-B00711250-00
1330	ME-B00711330-00

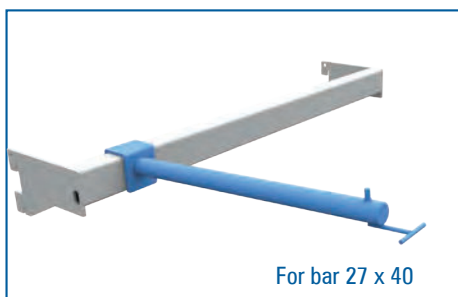

8 Wieszak • Hook • Broche • Halter • Hook

∅	D	Code
20	350	WB-A06620350-00
20	500	WB-A06620500-00

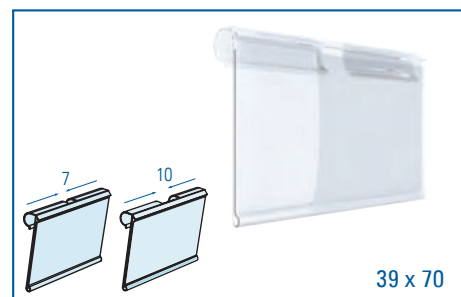

Etykieta wahliva przezroczysta • Clear swing ticket • Porte-étiquette en PVC Transparent • Etikettentasche transparent • Etiketten enveloppe

∅	Code
5 / 6 / 7	WA-E00000101
8 / 10	WA-E00000108

H- 1700

L- 1000

D-570

Hooks (For EURO Perforated Back panels)

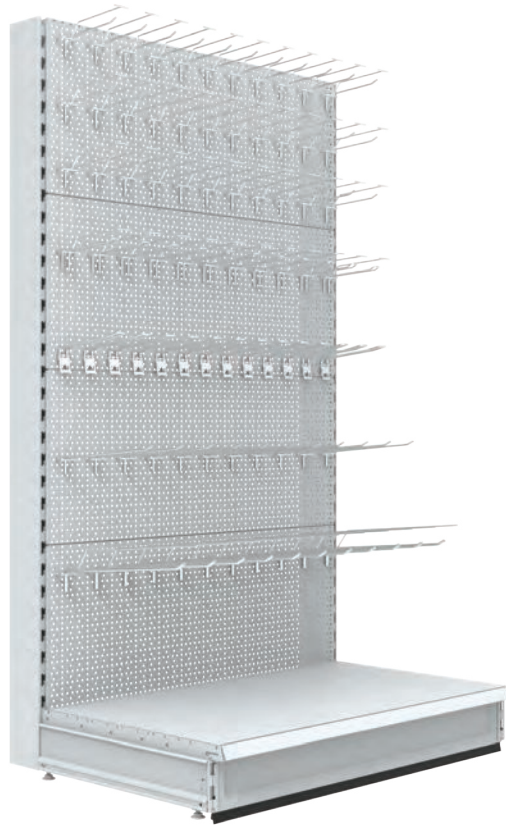

H- 1700

L- 1000 (3x)

D-570



Hooks

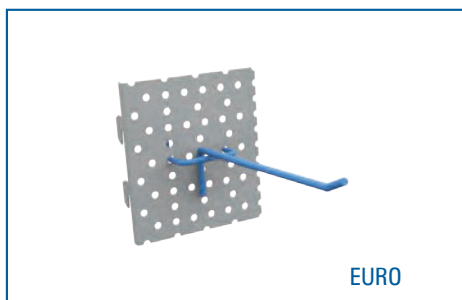

EURO

1 Wieszak • Hook • Broche • Halter • Haak

∅	D	Code
4	120	EM-P56040120-00
4	180	EM-P56040180-00
5	200	WT-N00105200-00
5	300	WT-N00105300-00
6	300	WT-N00106300-00
6	400	WT-N00106400-00

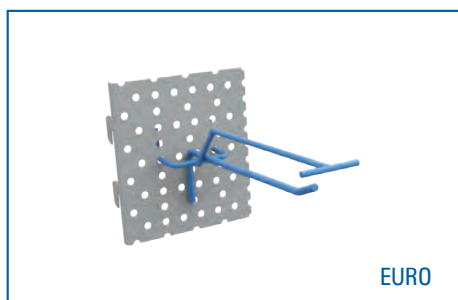

EURO

2 Wieszak • Hook • Broche • Halter • Haak

∅	D	Code
5	140	EM-P56150140-00
5	180	EM-P56150180-00

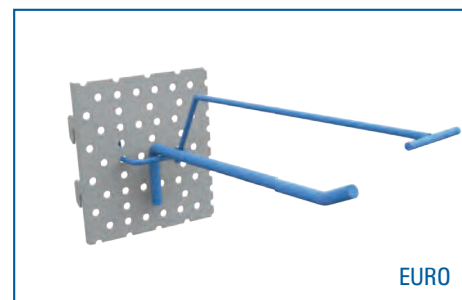

EURO

3 Wieszak • Hook • Broche • Halter • Haak

∅	D	Code
6	200	WT-N00906200-00
6	300	WT-N00906300-00
8	300	WT-N00908300-00
8	400	WT-N00908400-00

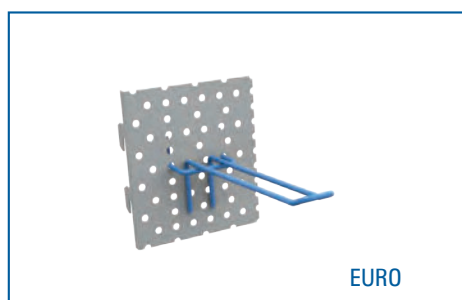

EURO

4 Wieszak • Hook • Broche • Halter • Haak

∅	D	Code
4	120	EM-P57040120-00
4	180	EM-P57040180-00
5	100	WT-N00205100-00
5	150	WT-N00205150-00
5	200	WT-N00205200-00
5	300	WT-N00205300-00

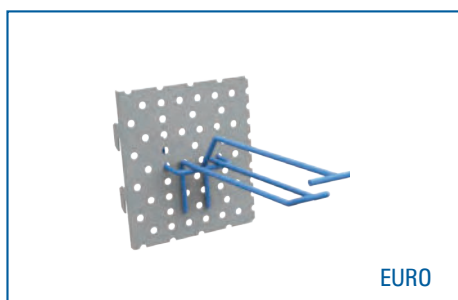

EURO

5 Wieszak • Hook • Broche • Halter • Haak

∅	D	Code
4	140	EM-P57140140-00
4	180	EM-P57140180-00

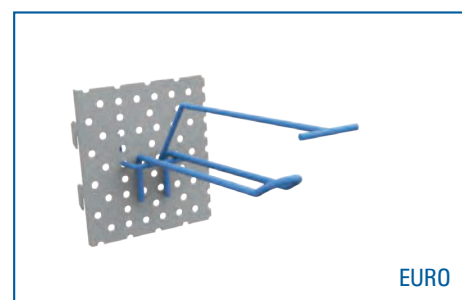

EURO

6 Wieszak • Hook • Broche • Halter • Haak

∅	D	Code
5	200	WT-N02005200-00
5	300	WT-N02005300-00

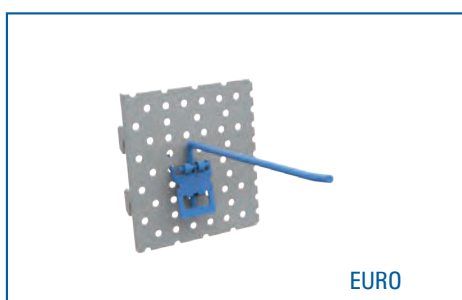

EURO

7 Wieszak • Hook • Broche • Halter • Haak

∅	D	Code
5	150	WT-N21405150-00
5	200	WT-N21405200-00
5	300	WT-N21405300-00
5	400	WT-N21405400-00

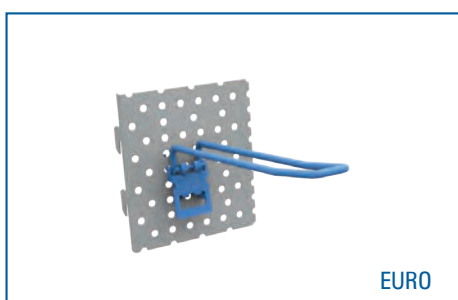

EURO

8 Wieszak • Hook • Broche • Halter • Haak

∅	D	Code
5	80	WT-N21005080-00
5	200	WT-N21005200-00

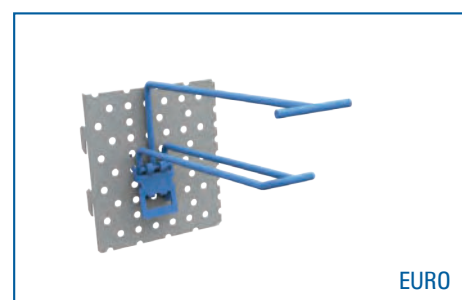

EURO

9 Wieszak • Hook • Broche • Halter • Haak

∅	D	Code
5	100	WT-N21105100-00
5	200	WT-N21105200-00
5	300	WT-N21105300-00

H- 1700

L- 1000

D-570

Hooks (For Panel & Spacewall back panels)



H- 1700

L- 1000 (3x)

D-570

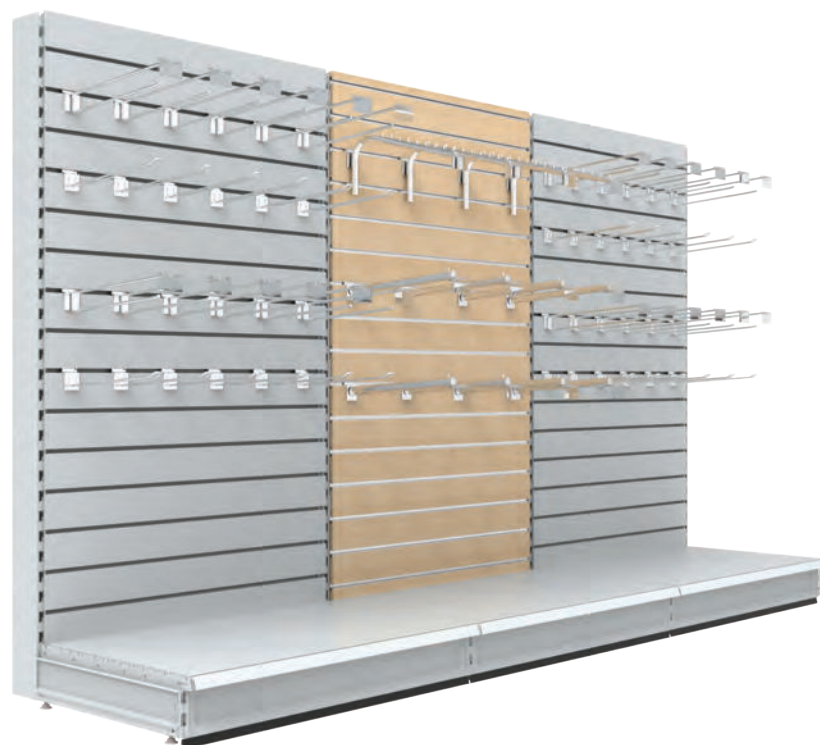

Akcesoria

Accessories

Accessoires

Zubehör

Accessoires

Hooks

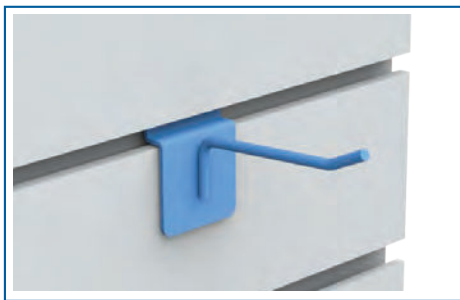

1 Wieszak • Hook • Broche • Halter • Haak

∅	D	Code
5	100	WP-A02105100-00
5	200	WP-A02105200-00
5	300	WP-A02105300-00

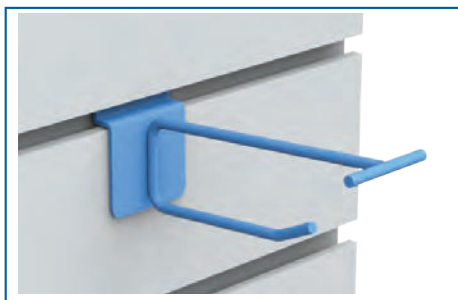

2 Wieszak • Hook • Broche • Halter • Haak

∅	D	Code
5	100	WP-A02205100-00
5	150	WP-A02205150-00
5	200	WP-A02205200-00



3 Wieszak • Hook • Broche • Halter • Haak

∅	D	Code
6	160	WP-A07106160-00



4 Wieszak • Hook • Broche • Halter • Haak

∅	D	Code
5	100	WP-A07405100-00
5	150	WP-A07405150-00
5	200	WP-A07405200-00

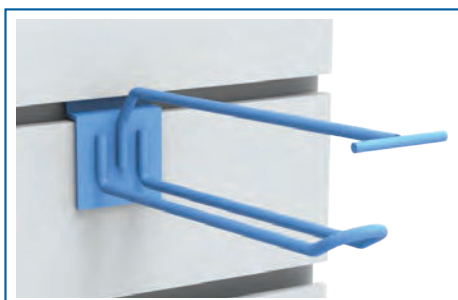

5 Wieszak • Hook • Broche • Halter • Haak

∅	D	Code
5	150	WP-A07305150-00
5	200	WP-A07305200-00



6 Wieszak • Hook • Broche • Halter • Haak

∅	D	Code
20	400	WP-A08720400-00

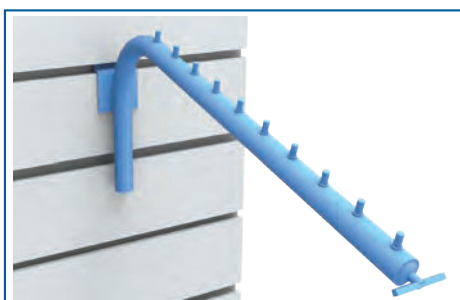

7 Wieszak • Hook • Broche • Halter • Kledinghaak

D	Code
400	WP-A08520400-00



8 Wieszak • Hook • Broche • Halter • Kledinghaak

H	D	Code
200	400	WP-A08620400-00

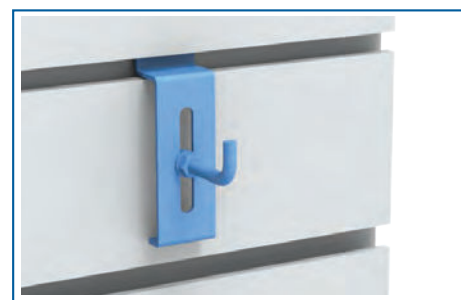

9 Wieszak • Hook • Broche • Halter • Haak

D	Diameter	Code
130	80	WP-A02706050-00

H- 1700

L- 900

D-570

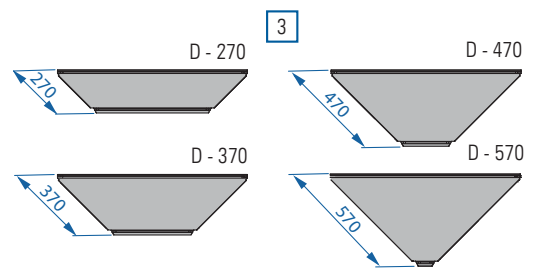
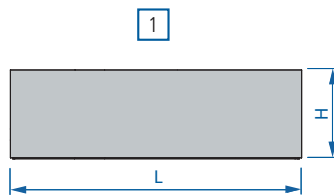
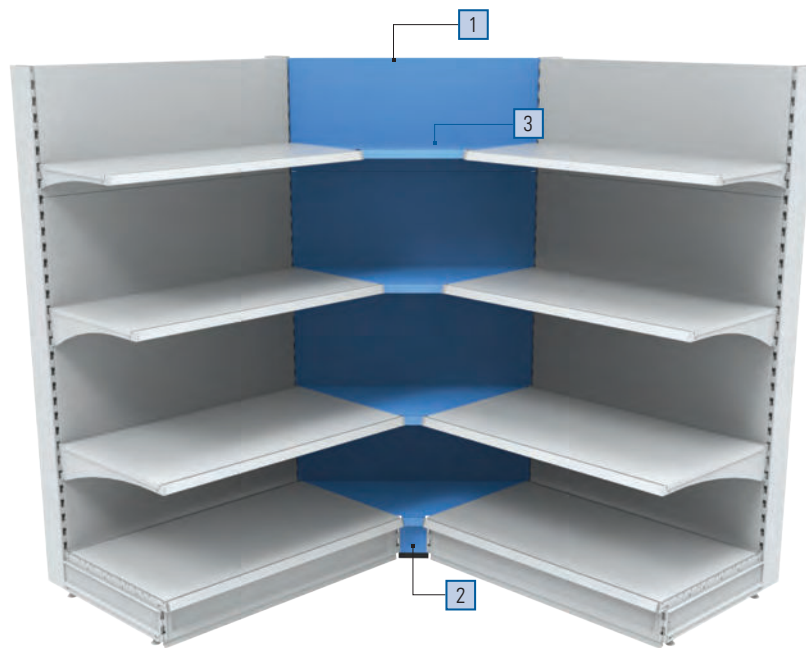
Corners
Plain Inner

1 Tyły • Back panels
Fonds • Rückwände • Achterwand

H	Code
100	ME-T02100900-00
200	ME-T02200900-00
300	ME-T02300900-00
400	ME-T02400900-00

2 Ostrona dolna • Plinth
Plinthe • Sockelblende • Plint

D	Code
270	OS-D87150270-00
370	OS-D87150370-00
470	OS-D87150470-00
570	OS-D87150570-00

3 Półka • Shelf
Tablette • Fachboden • Schap

D	Code
270	NE-P02270860-00
370	NE-P02370860-00
470	NE-P02470860-00
570	NE-P02570860-00

! For bracket selection see page 12-13

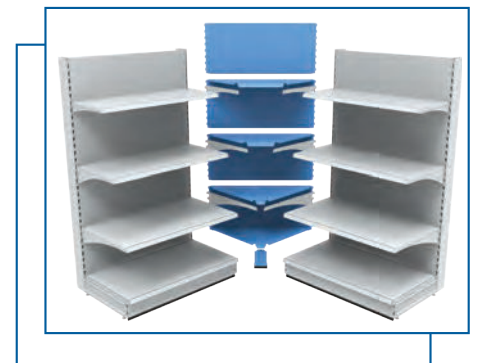

H- 1700

L- 180

D-570

**Corners
Plain Outer**

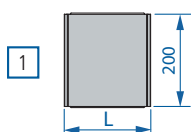
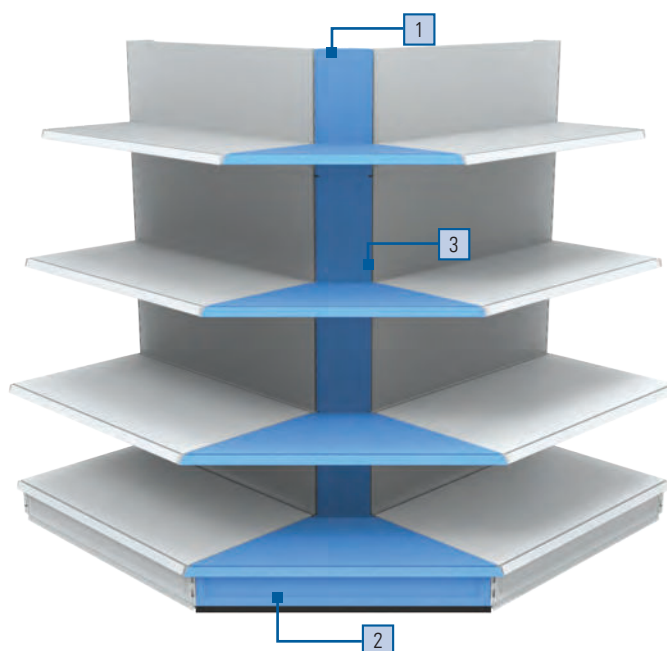

3

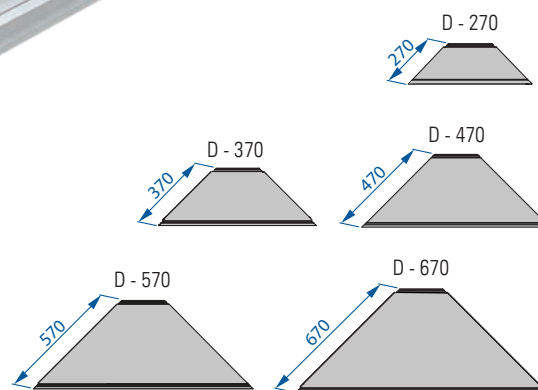

1 tyły • Back panels
Fonds • Rückwände • Achterwand

H	Code
100	ME-T03100200-00
200	ME-T03200200-00
300	ME-T03300200-00
400	ME-T03400200-00

2 Oslona dolna • Plinth
Plinthe • Sockelblende • Plint

D	Code
270	OS-D89150270-00
370	OS-D89150370-00
470	OS-D89150470-00
570	OS-D89150570-00
670	OS-D89150670-00

3 Półka • Shelf
Tablette • Fachboden • Schap

D	Code
270	NE-P03270200-00
370	NE-P03370200-00
470	NE-P03470200-00
570	NE-P03570200-00
670	NE-P03670200-00

! For bracket selection see page 12-13

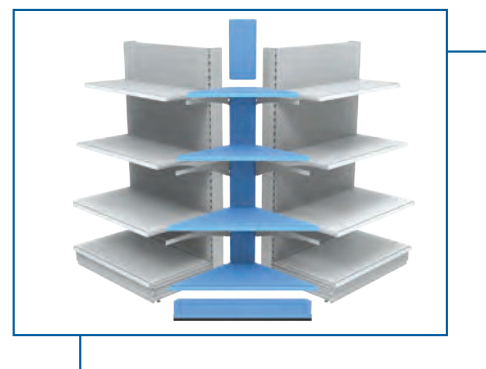

H- 900

L- 670

D-570

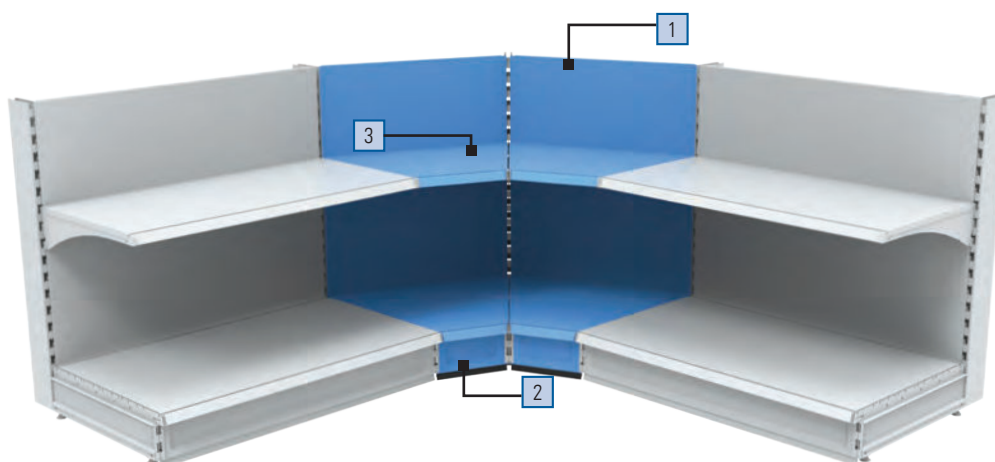
Corners
45° Inner

1

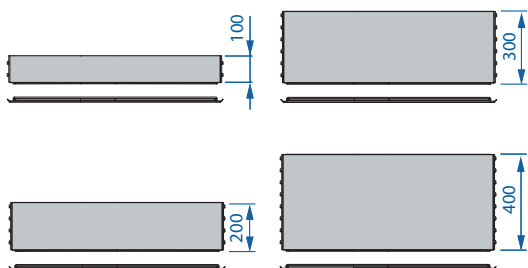

3

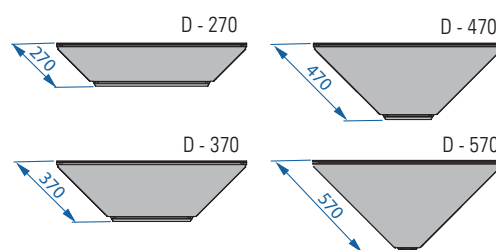
1 Tyl • Back panels
 Fonds • Rückwände • Achterwand

H	Code
100	TE-T02100670-00
200	TE-T02200670-00
300	TE-T02300670-00
400	TE-T02400670-00

2 Oslona dolna • Plinth
 Plinthe • Sockelblende • Plint

D	Code
270	OS-D77150270-00
370	OS-D77150370-00
470	OS-D77150470-00
570	OS-D77150570-00
670	OS-D77150670-00

3 Pólka • Shelf
 Tablette • Fachboden • Schap

D	Code
270	TE-P02270670-00
370	TE-P02370670-00
470	TE-P02470670-00
570	TE-P02570670-00

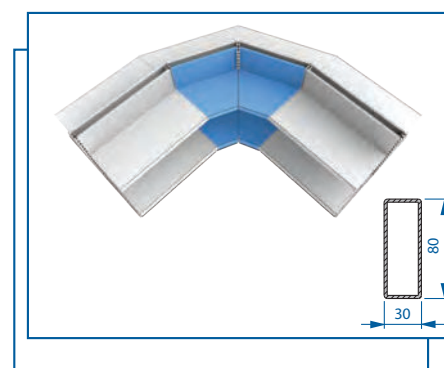
! For bracket selection see page 12-13

! Wall units: 30×60 30×80 30×110
 Gondola units: 30×80

H- 900

L- 730

D-570

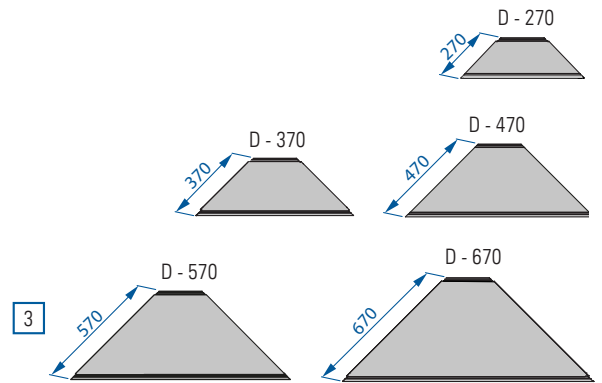
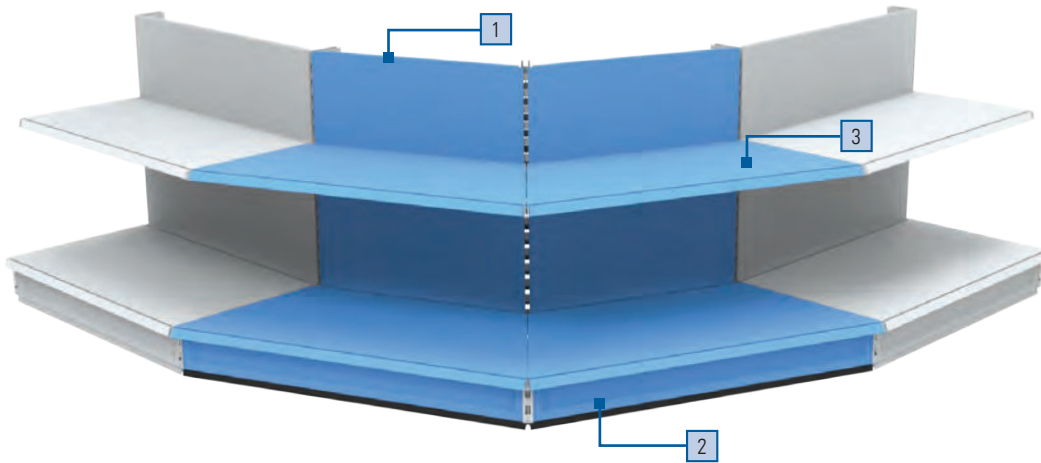
Corners
45° Outer



1 Tyły • Back panels
Fonds • Rückwände • Achterwand

H	Code
100	TE-T03100730-00
200	TE-T03200730-00
300	TE-T03300730-00
400	TE-T03400730-00

2 Oslona dolna • Plinth
Plinthe • Sockelblende • Plint

D	Code
270	OS-D83150270-00
370	OS-D83150370-00
470	OS-D83150470-00
570	OS-D83150570-00
670	OS-D83150670-00

3 Półka • Shelf
Tablette • Fachboden • Schap

D	Code
270	TE-P03270730-00
370	TE-P03370730-00
470	TE-P03470730-00
570	TE-P03570730-00
670	TE-P03670730-00

! For bracket selection see page 12-13

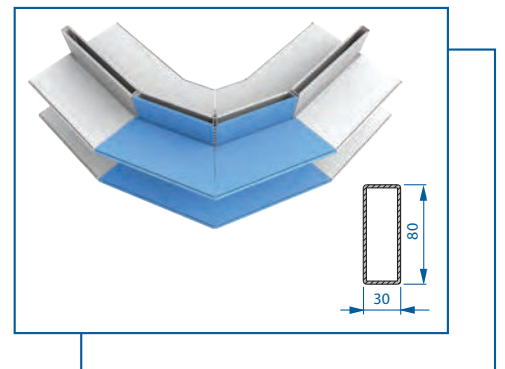

! Wall units: 30×60 30×80 30×110
Gondola units: 30×80

H- 1700 L- 670 D-570

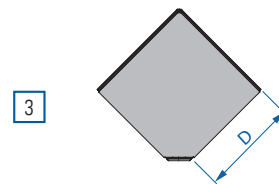
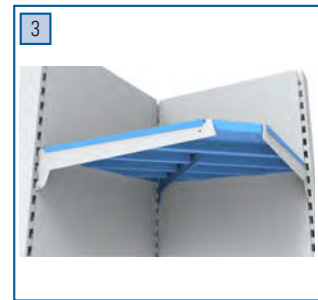
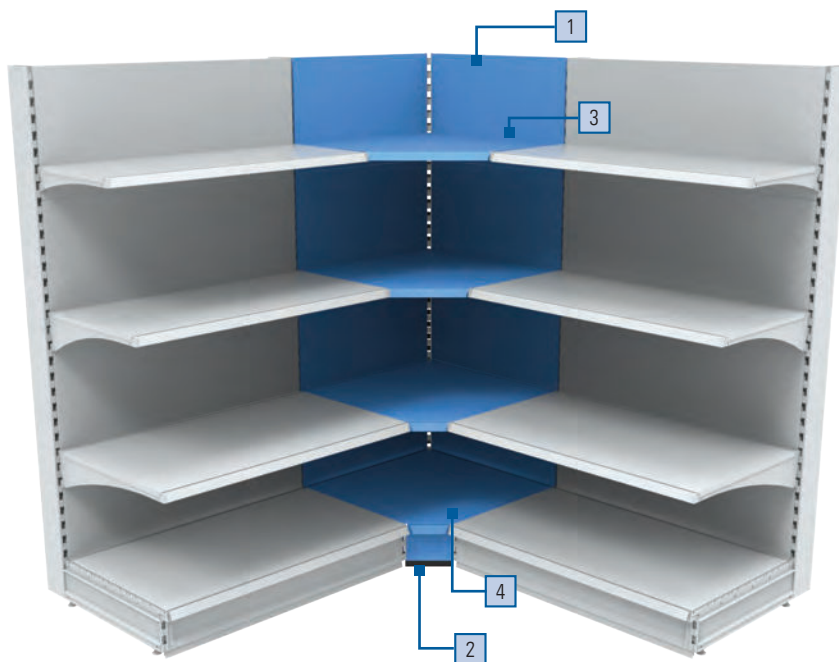
Corners
 90°

1 Tyla • Back panels
 Fonds • Rückwände • Achterwand

H	◀ Code	Code ▶
100	TE-T08100670-00	TE-T09100670-00
200	TE-T08200670-00	TE-T09200670-00
300	TE-T08300670-00	TE-T09300670-00
400	TE-T08400670-00	TE-T09400670-00

2 Oslona dolna • Plinth
 Plinthe • Sockelblende • Plint

D	Code
270	OS-D75150270-00
370	OS-D75150370-00
470	OS-D75150470-00
570	OS-D75150570-00

3 Pólka • Shelf
 Tablette • Fachboden • Schap

G	Kod	(i)
270	TE-P09270670	X
370	TE-P09370670	X
470	TE-P09470670	X
570	TE-P09570670	X

4 Pólka bazowa • Base shelf
 Étagère de base • Grundplatte • Basis schap

G	Kod	(i)
270	TE-P08270670	X
370	TE-P08370670	X
470	TE-P08470670	X
570	TE-P08570670	X



! For bracket selection see page 12-13

H- 1700

L- 800

D-570

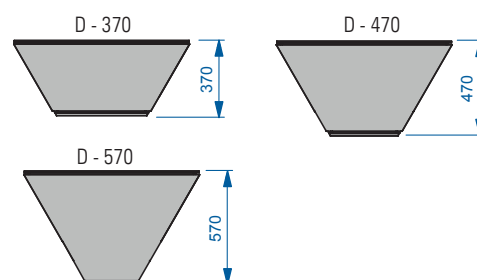
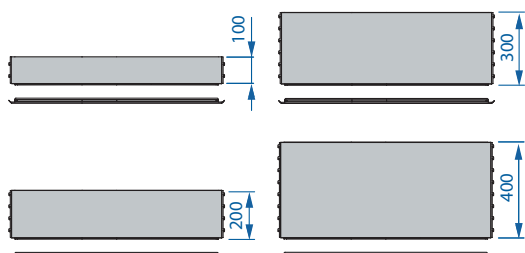
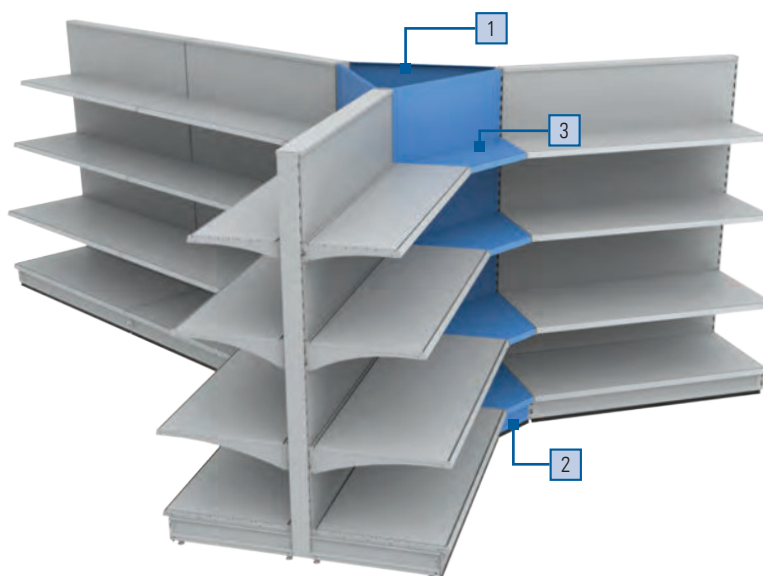
**Corners
Special**



1 Tyły • Back panels
Fonds • Rückwände • Achterwand

H	Code
100	MM-T79100800-00
200	MM-T79200800-00
300	MM-T79300800-00
400	MM-T79400800-00

2 Oslona dolna • Plinth
Plinthe • Sockelblende • Plint

D	Code
370	OS-D91150370-00
470	OS-D91150470-00
570	OS-D91150570-00

3 Półka • Shelf
Tablette • Fachboden • Schap

D	Code
370	MM-P79370800-00
470	MM-P79470800-00
570	MM-P79570800-00

! For bracket selection see page 12-13

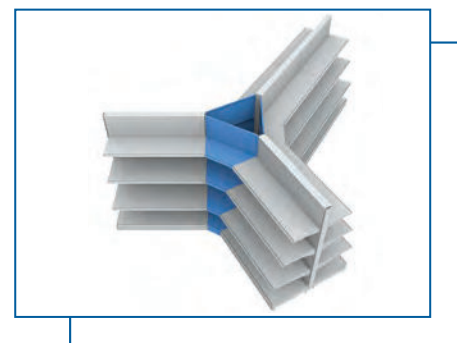

H- 2200

L- 1000

D-570

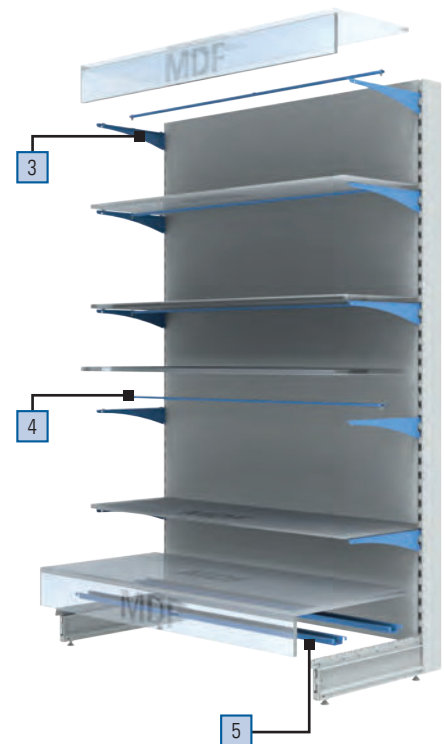
Dedicated Solutions
(for MDF, BOARDS)

For above presented solution 80×30 Drilled Uprights must be used !!

1 TIE BAR (required shelving reinforcement) • Belka Bar •
Barre de renfort • Verstärkung • Verstevigingsprofiel

L	Code
600	TE-B00020600-00
665	TE-B00020665-00
800	TE-B00020800-00
1000	TE-B00021000-00
1250	TE-B00021250-00
1330	TE-B00021333-00

2 MDF FIX • Uchwyt • Fixing
Fixation • Befestigung •

Fixation	Code
Left	CE-A00650100-00
Right	CE-A00660100-00

4 Wzmocnienie • Reinforcement Reinforcement •
Verstärkung • Verstevigingsprofiel

L	Code
600	ME-A43620600-00
665	ME-A43620665-00
800	ME-A43620800-00
1000	ME-A43621000-00
1250	ME-A43621250-00
1330	ME-A43621330-00

5 Wzmocnienie • Reinforcement Reinforcement •
Verstärkung • Verstevigingsprofiel

L	Code
600	ME-A50700600-00
665	ME-A50700665-00
800	ME-A50700800-00
1000	ME-A50701000-00
1250	ME-A50701250-00
1330	ME-A50701330-00

3 Wspornik • Bracket • Console
Konsole • Console

D	Left	Right
170	ME-W10060170-00	ME-W10070170-00
220	ME-W10060220-00	ME-W10070220-00
270	ME-W10060270-00	ME-W10070270-00
370	ME-W10060370-00	ME-W10070370-00
470	ME-W10060470-00	ME-W10070470-00

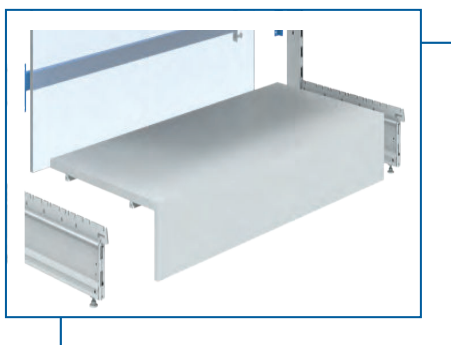

H- 2200

L- 1000

D-570

Dedicated Solutions
(for MDF, BOARDS)

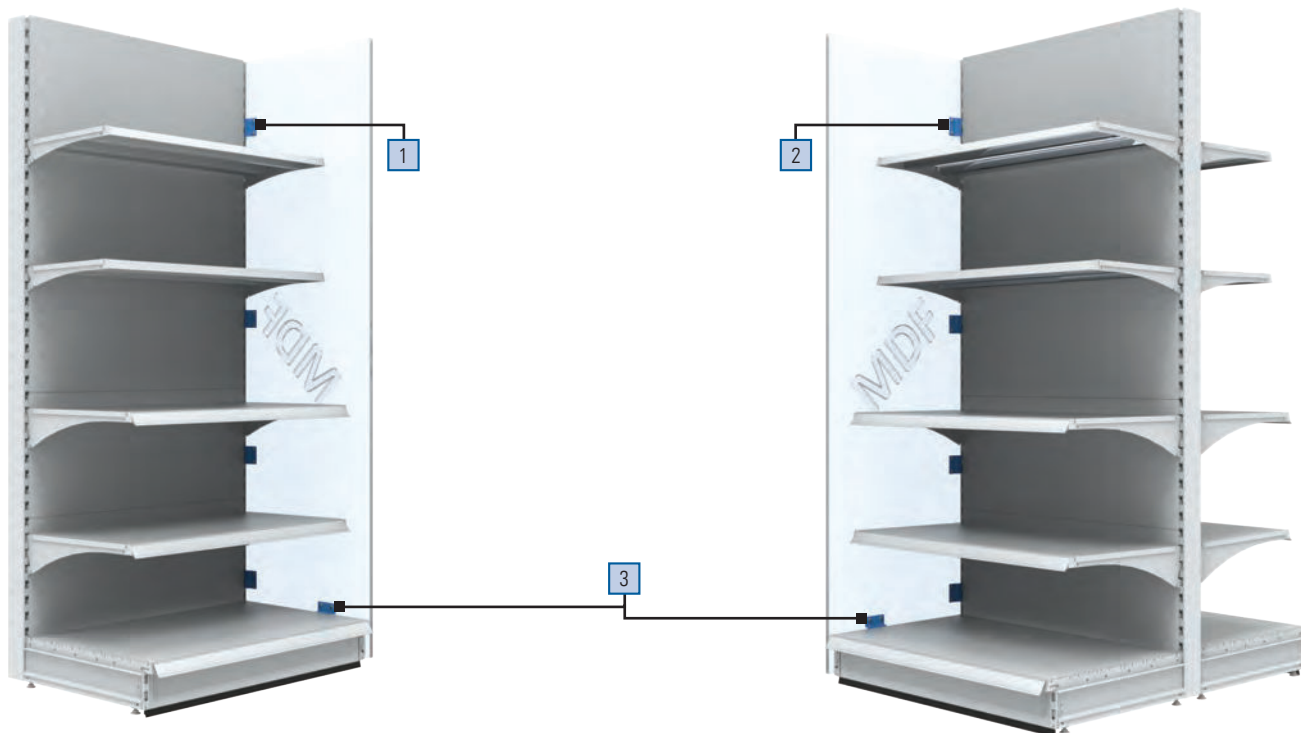

L - LEFT

R - RIGHT

B - BOTTOM



1 Uchwyt lewy • Fixing left Fixation • Befestigung
• zijwandhaak links

L	Code
L	CB-A40190065-00

2 Uchwyt prawy • Fixing right Fixation • Befestigung • Zijwandhaak rechts

L	Code
R	CB-A40200065-00

3 Uchwyt dolny • Fixing bottom Fixation • Befestigung
• Zijwandhaak bodem

L	Code
B	ME-A40330080-00



Other Elements

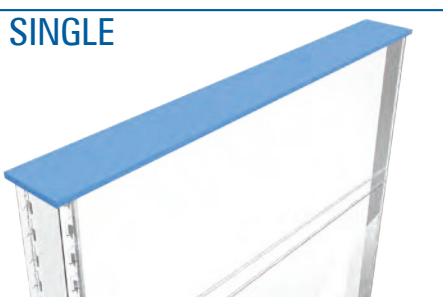
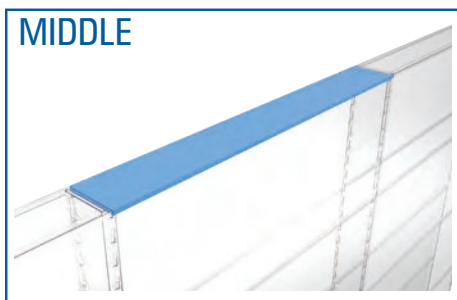

1 Oslona środkowa • Middle top cover • Cache de milieu
Abschlußabdeckung mittig • Afdekkap midden

L	Code	Code
600	OS-G03220600-00	OS-G03320600-00
665	OS-G03220665-00	OS-G03320665-00
800	OS-G03220800-00	OS-G03320800-00
1000	OS-G03221000-00	OS-G03321000-00
1200	OS-G03221200-00	OS-G03321200-00
1250	OS-G03221250-00	OS-G03321250-00
1330	OS-G03221330-00	OS-G03321330-00

a × b	60 × 30	80 × 30

2 Oslona pojedyncza • Single top cover • Cache simple
Abschlußabdeckung einfach • Afdekkap enkel

L	Code	Code
600	OS-G01220600-00	OS-G01320600-00
665	OS-G01220665-00	OS-G01320665-00
800	OS-G01220800-00	OS-G01320800-00
1000	OS-G01221000-00	OS-G01321000-00
1200	OS-G01221200-00	OS-G01321200-00
1250	OS-G01221250-00	OS-G01321250-00
1330	OS-G01221330-00	OS-G01321330-00

a × b	60 × 30	80 × 30

3 PLASTIC • Záslepka do profila • Upright Plug • Embout
de montant Deckkappe für Säule • Afdekkap stijl

a × b	Code	Code
30 × 30	BLACK	NO-Z00030030-81
	WHITE	NO-Z00030030-80
	GRAY	NO-Z00030030-87
60 × 30	BLACK	NO-Z00030060-81
	WHITE	NO-Z00030060-80
	GRAY	NO-Z00030060-87
80 × 30	BLACK	NO-Z00030080-81
	WHITE	NO-Z00030080-80
	GRAY	NO-Z00030080-87
110 × 30	BLACK	NO-Z00030110-87
	WHITE	NO-Z00030110-81
	GRAY	NO-Z00030110-87

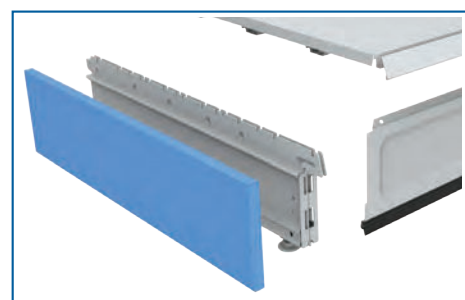
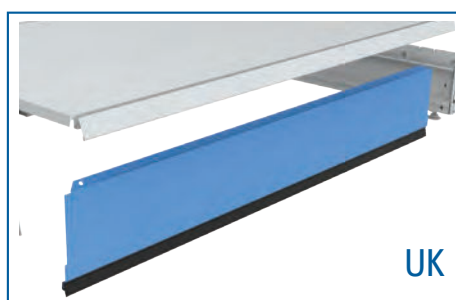
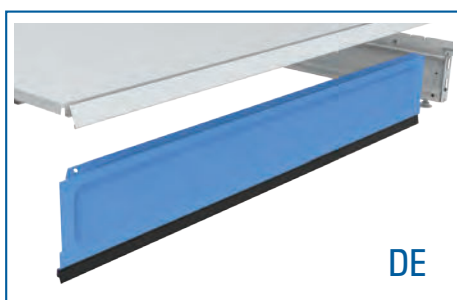

4 DE • Oslona dolna • Plinth • Plinthe
Sockelblende • Plint

L	Code
600	OS-D71150600-00
665	OS-D71150665-00
800	OS-D71150800-00
1000	OS-D71151000-00
1250	OS-D71151250-00
1330	OS-D71151330-00

5 UK • Oslona dolna • Plinth • Plinthe
Sockelblende • Plint glad

L	Code
600	OS-D73150600-00
665	OS-D73150665-00
800	OS-D73150800-00
1000	OS-D73151000-00
1200	OS-D73151200-00
1250	OS-D73151250-00
1330	OS-D73151330-00

6 Oslona stopy • Foot cover • Cache pied
Sockelverkleidung • Afdekkap voet

D	<- Code	Code ->
370	TE-A01130370-00	TE-A01140370-00
470	TE-A01130470-00	TE-A01140470-00
570	TE-A01130570-00	TE-A01140570-00
670	TE-A01130670-00	TE-A01140670-00
770	TE-A01130770-00	TE-A01140770-00

Other Elements



1 Mocowanie (do ściany) • Wall fix • Fixation (au mur)
Befestigung (an die Wand) • Wandbevestiging

L	H	Code
20	60	TE-A69402060-00

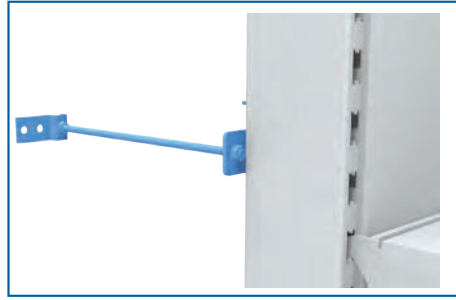

2 Mocowanie (do ściany) • Wall fix • Fixation (au mur)
Befestigung (an die Wand) • Wandbevestiging

L	Code
200	CE-A00340200-50
300	CE-A00340300-50
400	CE-A00340400-50

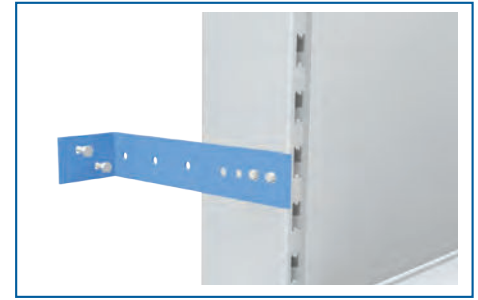

3 Mocowanie (do ściany) • Wall fix • Fixation (au mur)
Befestigung (an die Wand) • Wandbevestiging

L	Code
200	ME-A03710200-00
300	ME-A03710300-00
400	ME-A03710400-00



5 Stopka • Adjusting screw
Vérin • Fußsteller • Stelvoet

Code
ME-A00000005-50

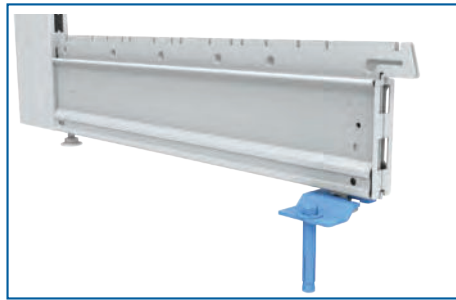

4 Mocowanie • Anchoring set • Fixation • Befestigung • Anker

Code
ME-A28010060-00



7 Wkładka • Insert • Insert • Rohreinsatz • Inslagdop stelvoet

Element	Size	Code
Insert	30x30	VV-A01700030-50
Insert	60x30	VV-A01700060-50
Insert	80x30	VV-A01700080-50
Insert	110x30	VV-A01700110-50

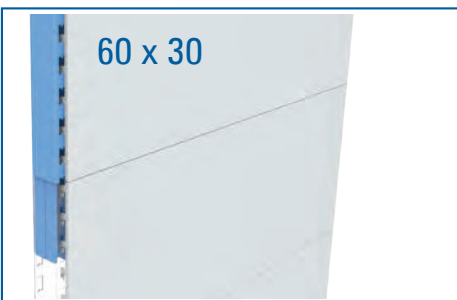

5 Przedłużka • Extension
Réhausse • Verlängerung • Opzetdeel stijl verlengstuk

Upright	L	Code
60x30	100	ME-A69906010-00
60x30	200	ME-A69906020-00
60x30	400	ME-A69906040-00
60x30	600	ME-A69906060-00

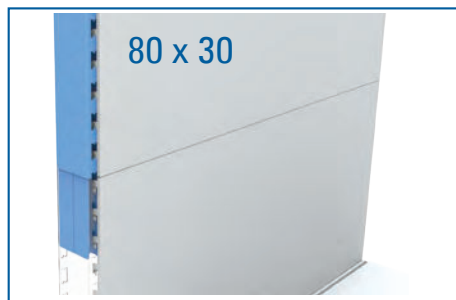

5 Przedłużka • Extension
Réhausse • Verlängerung • Opzetdeel stijl verlengstuk

Upright	L	Code
80x30	100	ME-A69908010-00
80x30	200	ME-A69908020-00
80x30	400	ME-A69908040-00
80x30	600	ME-A69908060-00



5 Przedłużka • Extension
Réhausse • Verlängerung • Opzetdeel stijl verlengstuk

Upright	L	Code
110x30	100	ME-A69901010-00
110x30	200	ME-A69901020-00
110x30	400	ME-A69901040-00
110x30	600	ME-A69901060-00

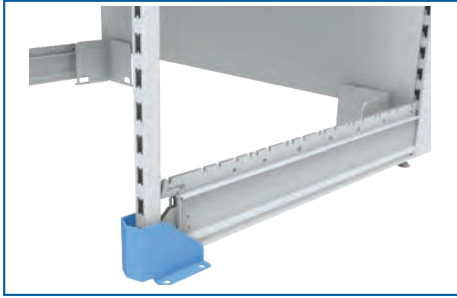

1 Odbojnik palety
Pallet guard • Butée • Abweiser • Voetbeschermer

	Code
Front	ME-A36990140-00

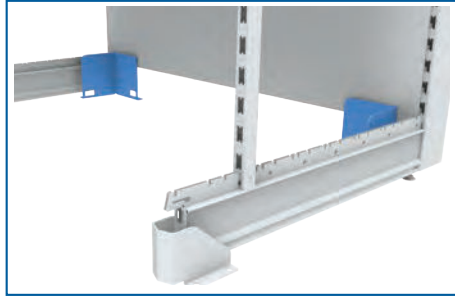

2 Odbojnik palety
Pallet guard • Butée • Abweiser • Voetbeschermer

	Code
Rear	ME-A36940150-00



3 Kotek • Peg
Cheville • Hochleistungsanker • Fixeeranker

screw	sleeve	Code
10x60	20x56	NO-000000120-50







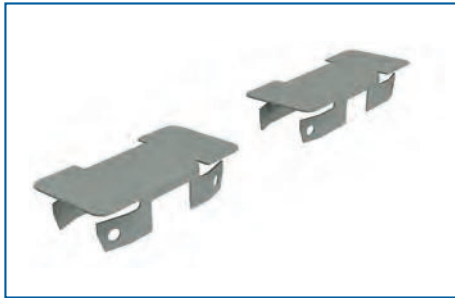



4 Mocowanie (do ściany) • Wall fix • Fixation (au mur)
Befestigung (an die Wand) • Wandbevestiging

	Code
30 × 90 ∅9	ME-A03970090-00



5 Zaślepka metalowa • Metal cap • Deckkappe Metall
Embout métallique • Afdekkap stijl

	Code
30 × 60	NO-Z08130060-00
30 × 80	NO-Z08130080-00

	RAL 9016 SHM STD		RAL 7035 SHM STD
	RAL 9005 SRU STD		RAL 9006 METALICZNY EXT
	TIGER 09/80170 G EXT		RAL 9001 SHM STD
	RAL 9010 G STD		RAL 7016 G STD
	RAL 9007 Metaliczny EXT		



Symbole: G – polysk; M – mat; SM – gladki, matowy; SHM – gladki, półmatowy;
SRU – strukturalny; HSRU – mlotkowy, strukturalny; STD – farba standardowa; EXT – farba specjalna

Symbols: G – gloss; M – mat; SM – smooth mat; SHM – smooth, half-mat;
SRU – structural; HSRU – hammer paint; STD – standard paint; EXT – special paint

Symboles: G – brillant; M – opaque; SM – lisse, opaque; SHM – lisse, demi-opaque;
SRU – structural; HSRU – de marteau, structural; STD – peinture standard; EXT – peinture spéciale

Symbole: G – glanz; M – matt; SM – glatt, matt; SHM – glatt, halbmatt;
SRU – strukturiert; HSRU – hammergeffekt, strukturiert; STD – Standardfarbe; EXT – Sonderfarbe

Symbolen: G – glans; M – mat; SM – gladde mat; SHM – glad, halfmat;
SRU – structureel; HSRU – hamerverf; STD – standaard verf; EXT – speciale verf

Product's TAG

CODE	TAG	CODE	TAG	CODE	TAG
CE-W10290150-00	W.OEYD	TE-N07003150-00	S.03N1M0	TE-N40600190-00	S.03N1M0
ME-A05070050-50	Z.M	TE-N07003180-00	S.03N1M0	TE-N40600200-00	S.03N1M0
ME-W00430390-00	W.M2B0	TE-N07003190-00	S.03N1M0	TE-N40600210-00	S.03N1M0
ME-W00430470-00	W.M2C0	TE-N07003200-00	S.03N1M0	TE-N40600220-00	S.03N1M0
ME-W00430570-00	W.M2D0	TE-N07003210-00	S.03N1M0	TE-N40600230-00	S.03N1M0
ME-W10010200-00	W.M2YU	TE-N07003220-00	S.03N1M0	TE-N40600240-00	S.03N1M0
ME-W10010270-00	W.M2AU	TE-N07003230-00	S.03N1M0	TE-N40600250-00	S.03N1M0
ME-W10010300-00	W.M2ZU	TE-N07003240-00	S.03N1M0	TE-N40600260-00	S.03N1M0
ME-W10010370-00	W.M2BU	TE-N07003250-00	S.03N1M0	TE-N40600300-00	S.03N1M0
ME-W10010470-00	W.M3CU	TE-N07003260-00	S.03N1M0	TE-N96337011-00	L.L11W2B
ME-W10010570-00	W.M3DU	TE-N07003300-00	S.03N1M0	TE-N96347011-00	L.L11W2B
ME-W10020570-00	W.M4DM	TE-N07006110-00	S.06W2M0	TE-N96357011-00	L.L11W2B
ME-W10020670-00	W.M4EM	TE-N07006120-00	S.06W2M0	TE-N96367011-00	L.L11W2B
ME-W10020770-00	W.M4FM	TE-N07006140-00	S.06W2M0	TE-N96377011-00	L.L11W2B
ME-W10030470-00	W.M3CM	TE-N07006160-00	S.06W2M0	TE-T20100600-00	T.M10G
ME-W10030570-00	W.M3DM	TE-N07006180-00	S.06W2M0	TE-T20100665-00	T.M10G
ME-W10030670-00	W.M3ES	TE-N07006200-00	S.06W2M0	TE-T20100800-00	T.M10G
ME-W12240470-00	W.M2CU	TE-N07006210-00	S.06W2M0	TE-T20101000-00	T.M10G
NE-P00200665-00	P.2NY006	TE-N07006220-00	S.06W2M0	TE-T20101250-00	T.M10G
NE-P00201000-00	P.2NY010	TE-N07006240-00	S.06W2M0	TE-T20101330-00	T.M10G
NE-P00201250-00	P.2NY012	TE-N07006260-00	S.06W2M0	TE-T20200600-00	T.M20G
NE-P00201330-00	P.2NY013	TE-N07006280-00	S.06W2M0	TE-T20200665-00	T.M20G
NE-P00270665-00	P.2NA106	TE-N07006300-00	S.06W2M0	TE-T20200800-00	T.M20G
NE-P00271000-00	P.2NA110	TE-N07008140-00	S.08W2M0	TE-T20201000-00	T.M20G
NE-P00271250-00	P.2NA112	TE-N07008160-00	S.08W2M0	TE-T20201250-00	T.M20G
NE-P00271330-00	P.2NA113	TE-N07008180-00	S.08W2M0	TE-T20201330-00	T.M20G
NE-P00370665-00	P.2NB206	TE-N07008200-00	S.08W2M0	TE-T20300600-00	T.M30G
NE-P00371000-00	P.2NB210	TE-N07008210-00	S.08W2M0	TE-T20300665-00	T.M30G
NE-P00371250-00	P.2NB212	TE-N07008220-00	S.08W2M0	TE-T20300800-00	T.M30G
NE-P00371330-00	P.2NB213	TE-N07008240-00	S.08W2M0	TE-T20301000-00	T.M30G
NE-P00470665-00	P.2NC206	TE-N07008260-00	S.08W2M0	TE-T20301250-00	T.M30G
NE-P00471000-00	P.2NC210	TE-N07008280-00	S.08W2M0	TE-T20301330-00	T.M30G
NE-P00471250-00	P.2NC312	TE-N07008300-00	S.08W2M0	TE-T20400600-00	T.M40G
NE-P00471330-00	P.2NC313	TE-N07011180-00	S.11W2M0	TE-T20400665-00	T.M40G
NE-P00570665-00	P.2ND306	TE-N07011200-00	S.11W2M0	TE-T20400800-00	T.M40G
NE-P00571000-00	P.2ND310	TE-N07011220-00	S.11W2M0	TE-T20401000-00	T.M40G
NE-P00571250-00	P.2ND312	TE-N07011240-00	S.11W2M0	TE-T20401250-00	T.M40G
NE-P00571330-00	P.2ND313	TE-N17006110-00	S.06W2M0	TE-T20401330-00	T.M40G
NE-P00670665-00	P.2NE306	TE-N17006120-00	S.06W2M0	TE-T20500600-00	T.M50G
NE-P00671000-00	P.2NE310	TE-N17006140-00	S.06W2M0	TE-T20500665-00	T.M50G
NE-P00671250-00	P.2NE312	TE-N17006160-00	S.06W2M0	TE-T20500800-00	T.M50G
NE-P00671330-00	P.2NE313	TE-N17006180-00	S.06W2M0	TE-T20501000-00	T.M50G
NE-P00770665-00	P.2NF406	TE-N17006200-00	S.06W2M0	TE-T20501250-00	T.M50G
NE-P00771000-00	P.2NF410	TE-N17006210-00	S.06W2M0	TE-T20501330-00	T.M50G
NE-P00771250-00	P.2NF412	TE-N17006220-00	S.06W2M0	TE-T21400665-00	T.M10P
NE-P00771330-00	P.2NF413	TE-N17008140-00	S.08W2M0	TE-T21401000-00	T.M20P
NE-P61210665-00	P.0NY106	TE-N17008160-00	S.08W2M0	TE-T21401250-00	T.M30P
NE-P61211000-00	P.0NY110	TE-N17008180-00	S.08W2M0	TE-T21401330-00	T.M40P
NE-P61211250-00	P.0NY112	TE-N17008200-00	S.08W2M0	TE-T22400665-00	T.M10P
NE-P61211330-00	P.0NY113	TE-N17008210-00	S.08W2M0	TE-T22401000-00	T.M20P
TE-B00020665-00	E.2B066	TE-N17008220-00	S.08W2M0	TE-T22401250-00	T.M30P
TE-B00021000-00	E.2B100	TE-N40600120-00	S.03N1M0	TE-T22401330-00	T.M40P
TE-B00021250-00	E.2B125	TE-N40600130-00	S.03N1M0	TE-W04030370-00	W.M2B0
TE-B00021333-00	E.2B133	TE-N40600140-00	S.03N1M0	TE-W04030470-00	W.M2C0
TE-N07003130-00	S.03N1M0	TE-N40600150-00	S.03N1M0	TE-W04030570-00	W.M2D0
TE-N07003160-00	S.03N1M0	TE-N40600170-00	S.03N1M0	TE-W04030670-00	W.M2EO
TE-N07003170-00	S.03N1M0	TE-N40600180-00	S.03N1M0	TE-W04030770-00	W.M2FO

Product's TAG

TAG	CODE	TAG	CODE	TAG	CODE
E.2B066	TE-B00020665-00	S.03N1M0	TE-N40600140-00	T.M10G	TE-T20101250-00
E.2B100	TE-B00021000-00	S.03N1M0	TE-N40600150-00	T.M10G	TE-T20101330-00
E.2B125	TE-B00021250-00	S.03N1M0	TE-N40600160-00	T.M10P	TE-T21400665-00
E.2B133	TE-B00021333-00	S.03N1M0	TE-N40600170-00	T.M10P	TE-T22400665-00
L.L11W2B	TE-N96337011-00	S.03N1M0	TE-N40600180-00	T.M20G	TE-T20200600-00
L.L11W2B	TE-N96347011-00	S.03N1M0	TE-N40600190-00	T.M20G	TE-T20200665-00
L.L11W2B	TE-N96357011-00	S.03N1M0	TE-N40600200-00	T.M20G	TE-T20200800-00
L.L11W2B	TE-N96367011-00	S.03N1M0	TE-N40600210-00	T.M20G	TE-T20201000-00
L.L11W2B	TE-N96377011-00	S.03N1M0	TE-N40600220-00	T.M20G	TE-T20201250-00
P.0NY106	NE-P61210665-00	S.03N1M0	TE-N40600230-00	T.M20G	TE-T20201330-00
P.0NY110	NE-P61211000-00	S.03N1M0	TE-N40600240-00	T.M20P	TE-T21401000-00
P.0NY112	NE-P61211250-00	S.03N1M0	TE-N40600250-00	T.M20P	TE-T22401000-00
P.0NY113	NE-P61211330-00	S.03N1M0	TE-N40600260-00	T.M30G	TE-T20300600-00
P.2NA106	NE-P00270665-00	S.03N1M0	TE-N40600300-00	T.M30G	TE-T20300665-00
P.2NA110	NE-P00271000-00	S.06W2M0	TE-N07006110-00	T.M30G	TE-T20300800-00
P.2NA112	NE-P00271250-00	S.06W2M0	TE-N07006120-00	T.M30G	TE-T20301000-00
P.2NA113	NE-P00271330-00	S.06W2M0	TE-N07006140-00	T.M30G	TE-T20301250-00
P.2NB206	NE-P00370665-00	S.06W2M0	TE-N07006160-00	T.M30G	TE-T20301330-00
P.2NB210	NE-P00371000-00	S.06W2M0	TE-N07006180-00	T.M30P	TE-T21401250-00
P.2NB212	NE-P00371250-00	S.06W2M0	TE-N07006200-00	T.M30P	TE-T22401250-00
P.2NB213	NE-P00371330-00	S.06W2M0	TE-N07006210-00	T.M40G	TE-T20400600-00
P.2NC206	NE-P00470665-00	S.06W2M0	TE-N07006220-00	T.M40G	TE-T20400665-00
P.2NC210	NE-P00471000-00	S.06W2M0	TE-N07006240-00	T.M40G	TE-T20400800-00
P.2NC312	NE-P00471250-00	S.06W2M0	TE-N07006260-00	T.M40G	TE-T20401000-00
P.2NC313	NE-P00471330-00	S.06W2M0	TE-N07006280-00	T.M40G	TE-T20401250-00
P.2ND306	NE-P00570665-00	S.06W2M0	TE-N07006300-00	T.M40G	TE-T20401330-00
P.2ND310	NE-P00571000-00	S.06W2M0	TE-N17006110-00	T.M40P	TE-T21401330-00
P.2ND312	NE-P00571250-00	S.06W2M0	TE-N17006120-00	T.M40P	TE-T22401330-00
P.2ND313	NE-P00571330-00	S.06W2M0	TE-N17006140-00	T.M50G	TE-T20500600-00
P.2NE306	NE-P00670665-00	S.06W2M0	TE-N17006160-00	T.M50G	TE-T20500665-00
P.2NE310	NE-P00671000-00	S.06W2M0	TE-N17006180-00	T.M50G	TE-T20500800-00
P.2NE312	NE-P00671250-00	S.06W2M0	TE-N17006200-00	T.M50G	TE-T20501000-00
P.2NE313	NE-P00671330-00	S.06W2M0	TE-N17006210-00	T.M50G	TE-T20501250-00
P.2NF406	NE-P00770665-00	S.06W2M0	TE-N17006220-00	T.M50G	TE-T20501330-00
P.2NF410	NE-P00771000-00	S.08W2M0	TE-N07008140-00	W.M2AU	ME-W10010270-00
P.2NF412	NE-P00771250-00	S.08W2M0	TE-N07008160-00	W.M2BO	ME-W00430390-00
P.2NF413	NE-P00771330-00	S.08W2M0	TE-N07008180-00	W.M2BO	TE-W04030370-00
P.2NY006	NE-P00200665-00	S.08W2M0	TE-N07008200-00	W.M2BU	ME-W10010370-00
P.2NY010	NE-P00201000-00	S.08W2M0	TE-N07008210-00	W.M2CO	ME-W00430470-00
P.2NY012	NE-P00201250-00	S.08W2M0	TE-N07008220-00	W.M2CO	TE-W04030470-00
P.2NY013	NE-P00201330-00	S.08W2M0	TE-N07008240-00	W.M2CU	ME-W12240470-00
S.03N1M0	TE-N07003130-00	S.08W2M0	TE-N07008260-00	W.M2DO	ME-W00430570-00
S.03N1M0	TE-N07003140-00	S.08W2M0	TE-N07008280-00	W.M2DO	TE-W04030570-00
S.03N1M0	TE-N07003150-00	S.08W2M0	TE-N07008300-00	W.M2EO	TE-W04030670-00
S.03N1M0	TE-N07003160-00	S.08W2M0	TE-N17008140-00	W.M2FO	TE-W04030770-00
S.03N1M0	TE-N07003170-00	S.08W2M0	TE-N17008160-00	W.M2YU	ME-W10010200-00
S.03N1M0	TE-N07003180-00	S.08W2M0	TE-N17008180-00	W.M2ZU	ME-W10010300-00
S.03N1M0	TE-N07003190-00	S.08W2M0	TE-N17008200-00	W.M3CU	ME-W10010470-00
S.03N1M0	TE-N07003200-00	S.08W2M0	TE-N17008210-00	W.M3DM	ME-W10030570-00
S.03N1M0	TE-N07003210-00	S.08W2M0	TE-N17008220-00	W.M3DU	ME-W10010570-00
S.03N1M0	TE-N07003220-00	S.11W2M0	TE-N07011180-00	W.M3ES	ME-W10030670-00
S.03N1M0	TE-N07003230-00	S.11W2M0	TE-N07011200-00	W.M3CM	ME-W10030470-00
S.03N1M0	TE-N07003240-00	S.11W2M0	TE-N07011220-00	W.M4DM	ME-W10020570-00
S.03N1M0	TE-N07003250-00	S.11W2M0	TE-N07011240-00	W.M4EM	ME-W10020670-00
S.03N1M0	TE-N07003260-00	T.M10G	TE-T20100600-00	W.M4FM	ME-W10020770-00
S.03N1M0	TE-N07003300-00	T.M10G	TE-T20100665-00	W.OEYD	CE-W10290150-00
S.03N1M0	TE-N40600120-00	T.M10G	TE-T20100800-00	Z.M	ME-A05070050-50

SMARTLINE

WINKELINTERIEUR

Imboslaan 130

6951 KC Dieren

info@smartline.sale

www.smartline.sale