

High storage system HX

SMARTLINE
WINKELINTERIEUR



Table of Contents

GENERAL INFORMATION

Structural features	4
Types of pillars, frames and bracings	5
Dimensions	6
Warehouse stands	8
Levelling shims	12
Crossbeams - structural features	14
Types and cross-sections of crossbeams	15
Numbering of rows	18
Pallet safeguard	19
Crossbeams	21
Articulation	22
Rack guards	23
Shelves	24
Platform grating	26
Mesh shelves	27

INTEGRATION OF STORE AND WAREHOUSE RACKS

Single integration with rack reduced depth	29
Double integration	30
Two-sided integration	31
Single integration	32
Integration brackets	37
Pallet safeguard	38

INTEGRATION DIY SOLUTIONS

Dividers	41
Hangers	45
Perforated door	49
Panel holder	50
Rack with reduced depth	53

CASH & CARRY SOLUTIONS

Lighting	56
Dividers and front strips	57
Baskets	58
Promotional stands	59



The idea of a rack system consists in offering a possibility to arrange rack alleys comprising one, two and multiple segments, with a possibility to provide various storage levels in each one of them.

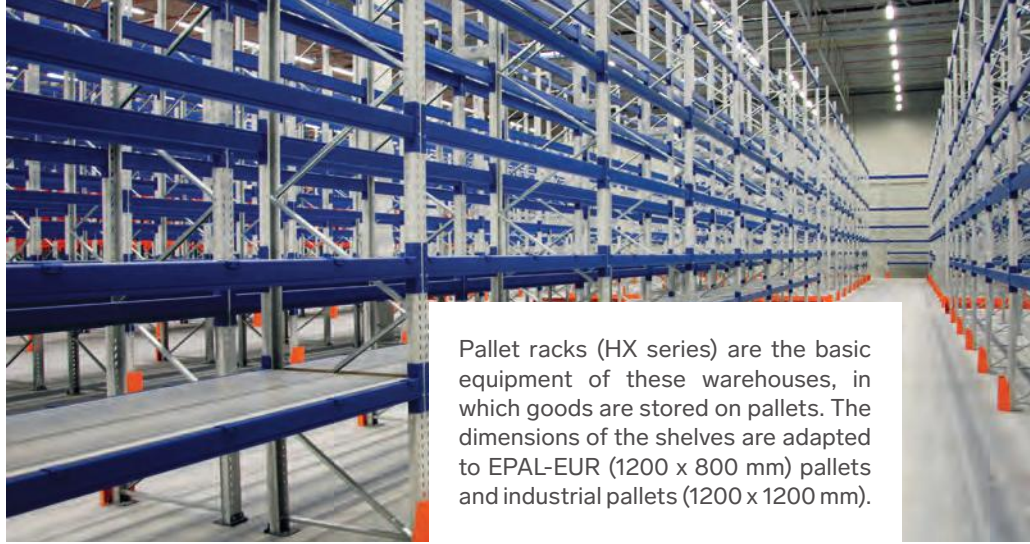

Pallet racks (HX series) are the basic equipment of these warehouses, in which goods are stored on pallets. The dimensions of the shelves are adapted to EPAL-EUR (1200 x 800 mm) pallets and industrial pallets (1200 x 1200 mm).

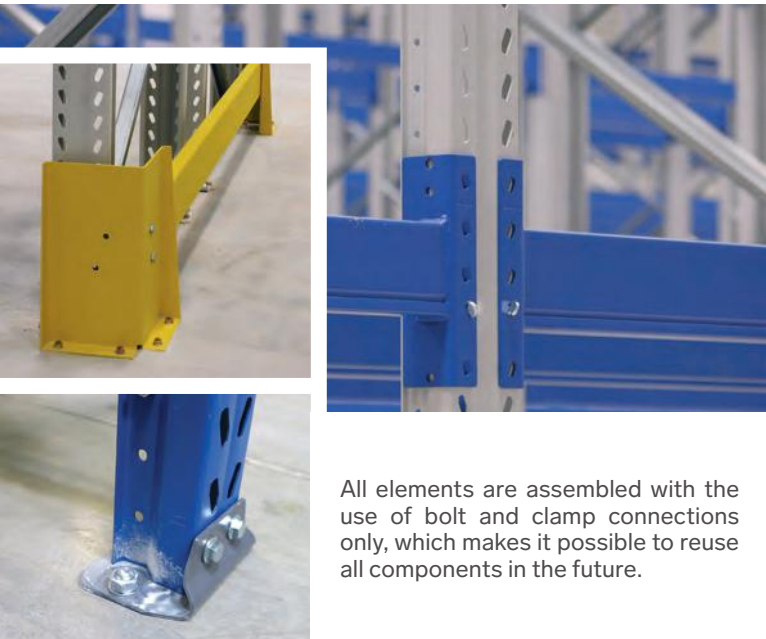

All elements are assembled with the use of bolt and clamp connections only, which makes it possible to reuse all components in the future.

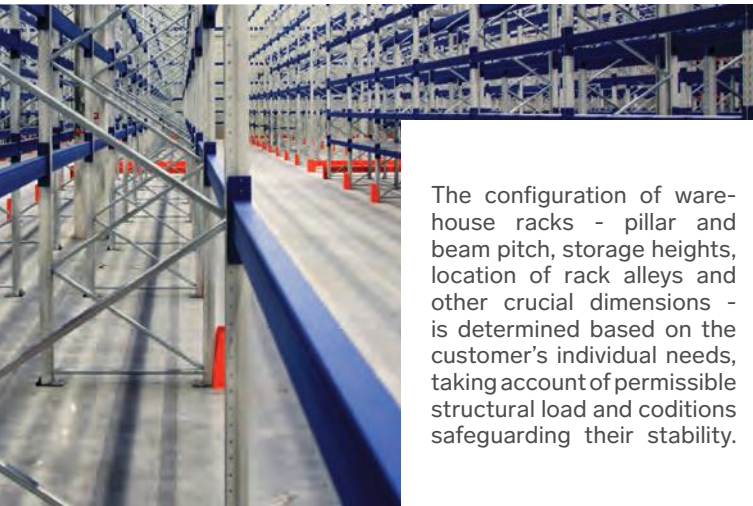

The configuration of warehouse racks - pillar and beam pitch, storage heights, location of rack alleys and other crucial dimensions - is determined based on the customer's individual needs, taking account of permissible structural load and conditions safeguarding their stability.

The HX warehouse shelving system is designed and manufactured in accordance with international construction standards. When it comes to the quality of the product itself, it is worth noting that the shelves for the MAGO brand store have a GS safety certificate, issued by the German institute TUV Rheinland. This certificate is a confirmation that the shelves have been evaluated and tested for quality and safety according to strict German and European regulations.

Important note!

Mago S.A. is an owner of design of a system of HX warehouse racks. Components of racks are manufactured by MGL Sp. z o.o.

TECHNICAL INFORMATION

HIGH STORAGE SYSTEM HX

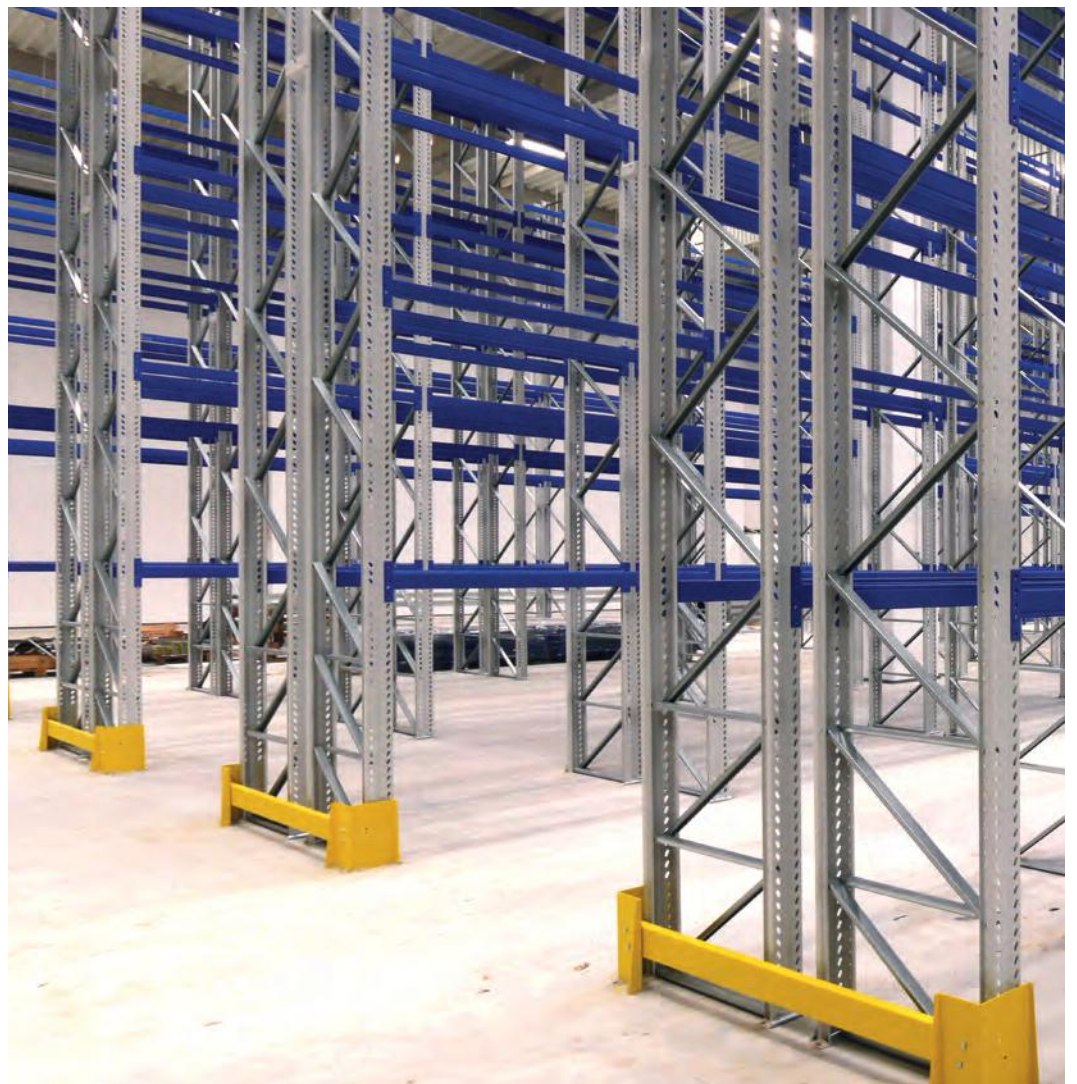

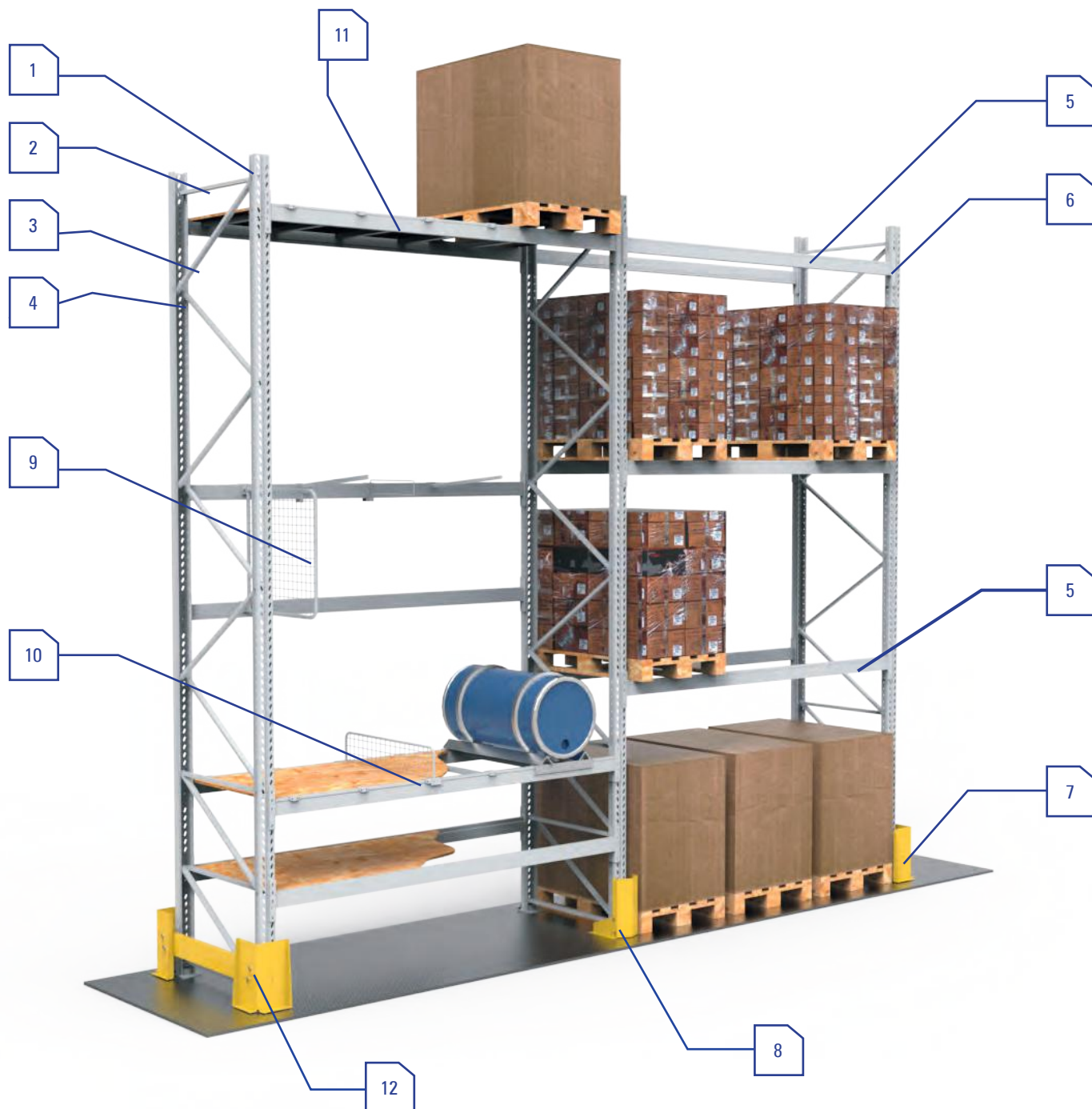

Basic components:

1 - pillar (profile, foot, screws with nuts); 2 - horizontal bracing;
3 - diagonal bracing; 4 - screw, nut, spacer sleeve; [elements 1-4
form the frame (stand) of a rack]; 5 - crossbeam; 6 - safeguard

Additional components: 7 - corner rack guard; 8 - front rack
guard; 12 - fender beam

Accessories: 9, 10 - separators; 11 - crossbeam

TYPES OF FRAME PILLARS

The HX system provides for a truss structure composed of two pillars joined by bracings. Pillars are made of perforated, steel open profiles with external dimensions of 82 × 70, 102 × 70 and 122 × 70 mm. The pillars include two rows of assembly openings positioned vertically every 50 mm.

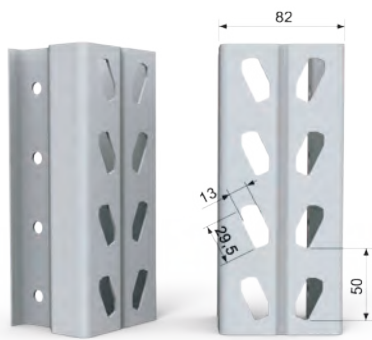

HX82 PILLAR PROFILE

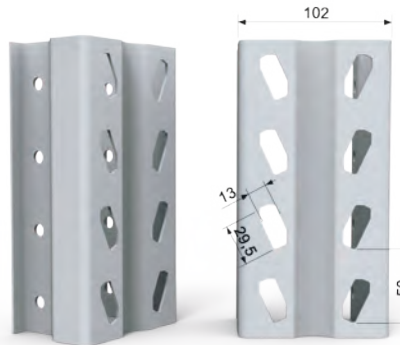

HX102 PILLAR PROFILE

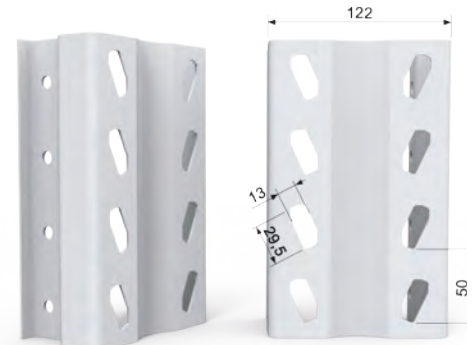

HX122 PILLAR PROFILE

FRAME BRACING SYSTEMS

The foot, which forms the frame's basis, provides appropriate distribution of load to the floor and anchorage of the rack to the ground.

Bracings serve the purpose of joining two pillars into a frame. When it comes to a mounting method, we can distinguish two types of bracings:

- horizontal, mounted perpendicularly to pillars
- diagonal, mounted between two consecutive horizontal bracings.

The HX(S) system provides for mounting of frames with two bracing systems, labelled as "S" and "ZZS".

The "ZZS" system allows distributing slightly greater loads than the "S" system.

The "ZZS" system considerably enhances resistance of the lower part of the pillar to destruction as a result of being hit by a forklift.

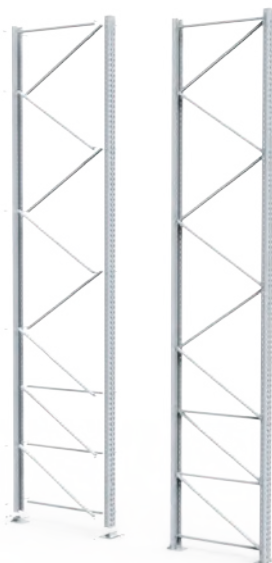

HX FRAME WITH A "ZZS" BRACING SYSTEM



HX FRAME WITH AN "S" BRACING SYSTEM

CROSSBEAM DIMENSIONS

FOR CROSSBEAMS WITH A WIDTH OF 40 MM

Frame Gh	Gz [mm] Gz=Gh-30	Gw [mm]	Gr [mm]
750	720	640	627
1050	1020	940	927
1130	1100	1020	1007

FOR CROSSBEAMS WITH A WIDTH OF 50 MM

Frame Gh	Gz [mm] Gz=Gh-30	Gw [mm]	Gr [mm]
750	720	620	607
1050	1020	920	907
1130	1100	1000	987

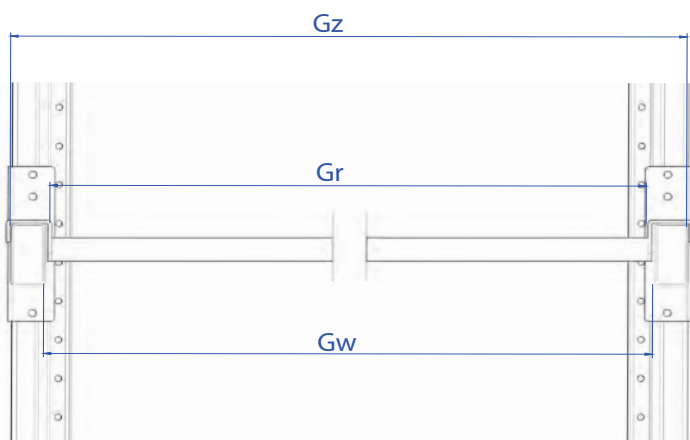

LONGITUDINAL DIMENSIONS

FOR HX 82 FRAME

Profile width A [mm]	Foot width B [mm]	T [mm]	L [mm]	Lr [mm]	Commercial dimensions
82	144	1882	1800	1792	1800
		2782	2700	2692	2700
		3682	3600	3592	3600

FOR HX 102 FRAME

Profile width A [mm]	Foot width B [mm]	T [mm]	L [mm]	Lr [mm]	Commercial dimensions
102	164	1902	1800	1792	1800
		2802	2700	2692	2700
		3702	3600	3592	3600

FOR HX 122 FRAME

Profile width A [mm]	Foot width B [mm]	T [mm]	L [mm]	Lr [mm]	Commercial dimensions
122	184	1922	1800	1792	1800
		2822	2700	2692	2700
		3622	3600	3592	3600

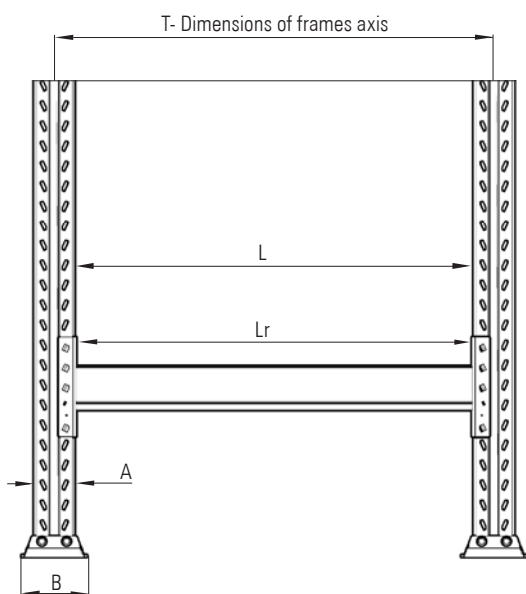

Pursuant to the requirements of applicable EN 15512 standard, it is necessary to individually check the resistance of each rack configuration. It results from the fact that utilization of carrying capacity of structural elements of the rack (frames and beams) largely depends on an individual configuration. Thorough assessment needs to be performed individually for a verified structure, taking account of details of its configuration, warehousing conditions, carrying capacity of the ground, setting of racks, etc.

In order to facilitate initial selection of elements and provide for labelling of components with nominal load values, below you will find a set of results that represent permissible values in the best possible way.

These values are called **reference values** and they were obtained as a result of calculation of reference structures, in accordance with requirements laid down in the standard. Therefore, these **values have been confirmed 100% only with regard to a specific reference structure** (see "HX racks assembly and operating instructions", page 59 and 62). As regards a specific, real-life rack, permissible values may differ slightly from reference values.

Every effort has been made so that the presented reference values represented permissible loads of real structures in the best possible way. Experience and number of verified configurations have confirmed the appropriateness of the applied method and presented values. **Nevertheless, in order to safeguard compliance with the requirements of EN15512 standard, we need to remember that the set of "reference values" presented below does not lift the need for comprehensive verification of the structure..**

PERMISSIBLE LOAD OF FRAMES AND CROSSBEAMS [KG]

Nest height h [mm]	Load Q [kg]							
	HX 82 „S“	HX 82 „ZZS“	HX 102 0185 „S“	HX 102 0185 „ZZS“	HX 102 0220 „S“	HX 102 0220 „ZZS“	HX 122 „S“	HX 122 „ZZS“
800	11700	12450	13800	14550	16380	17280	19620	20880
1000	11160	12240	13560	14280	16200	16950	19200	20100
1200	10890	11970	13320	13860	16080	16560	19080	19680
1400	10575	11325	13050	13350	15646	15750	18690	18900
1600	10050	10500	12525	12825	15120	15120	18000	18000
1800	9300	9600	12000	12360	14400	14400	17325	17325
2000	8520	8820	11520	11520	13500	13575	16425	16425
2200	7740	7740	10935	10935	12840	12840	15600	15600
2400	7200	7200	10170	10170	11760	11760	14580	14580

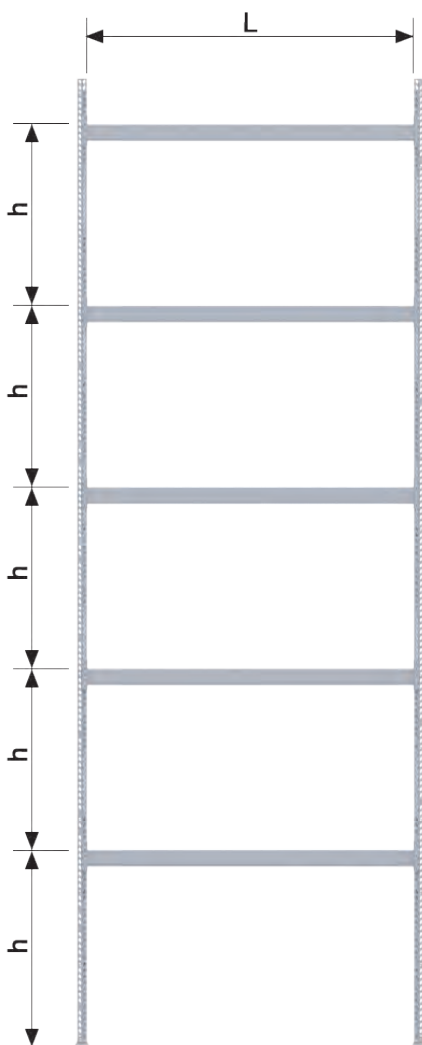

PERMISSIBLE LOAD OF A PAIR OF CROSSBEAMS (ONE SHELF) [KG]

Cross section	Length of (Crossbeam) beams L [mm]									
	1200	1500	1800	2100	2400	2700	3000	3300	3600	3900
5N060	1600	1350	1180	1050	880	720	600	505	435	370
5N080	2320	1940	1680	1500	1340	1220	1050	900	770	670
5N100	3250	2740	2360	2100	1880	1715	1580	1455	1330	1160
5N125	5350	4400	3750	3270	2920	2655	2420	2250	2090	1950
4S060	2080	1760	1530	1310	1060	855	720	610	525	450
4S080	2500	2080	1800	1600	1440	1305	1080	920	790	690
4S100	4000	3300	2860	2510	2260	2070	1890	1760	1500	1320
4S120	5120	4180	3580	3160	2840	2550	2340	2175	2010	1890
4S140	6000	5250	4430	3860	3440	3120	2850	2625	2420	2280
4C100	5200	4250	3610	3200	2820	2500				
4C120	5900	4900	4100	3600	3160	2835				
5C100	6000	5100	4350	3800	3400	3000	2500	2100	1800	
5C110	6000	5700	4900	4300	3800	3400	2970	2500	2130	
5C120	6000	6000	5500	4800	4200	3800	3450	3000	2550	
5C130	6000	6000	5900	5150	4600	4050	3660	3350	3000	
5C140	6000	6000	6000	5950	5300	4800	4250	3850	3500	
5S100	6000	5800	5000	4400	3450	2800	2300	1950	1680	1450
5S120	6000	6000	6000	5500	4900	4200	3400	2850	2430	2100
5S140	6000	6000	6000	6000	6000	6000	5400	4500	3750	3250
5S150	6000	6000	6000	6000	6000	6000	6000	5250	4500	3800

BRACING LAYOUT „S”

BRACING LAYOUT „ZZS”

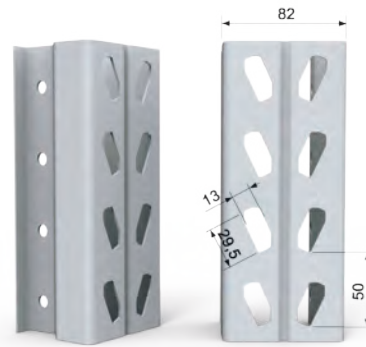
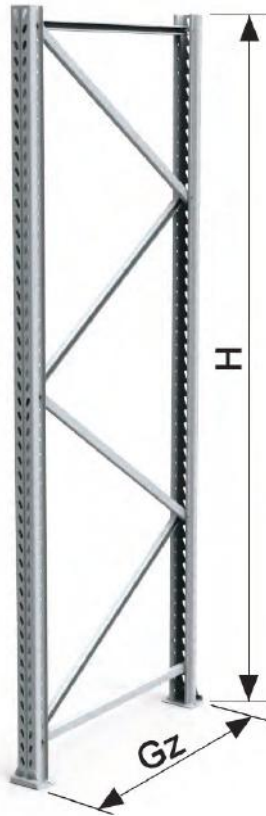

HX 82 PILLAR PROFILE

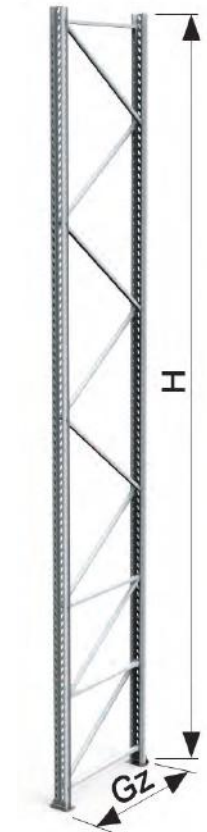

WAREHOUSE STAND: HX82 0185 BRACING LAYOUT „S”

WAREHOUSE STAND: HX82 0185 BRACING LAYOUT „ZZS”

Commercial depth Gh	Depth Gz [mm]	Height H [mm]	Product code
750	720	1000	HX-N25150100
		1200	HX-N25150120
		stroke per 200mm	HX-N2515...
		11800	HX-N25151180
		12000	HX-N25151200
1050	1020	1000	HX-N25330100
		1200	HX-N25330120
		stroke per 200mm	HX-N2533...
		11800	HX-N25331180
		12000	HX-N25331200
1130	1100	1000	HX-N25380100
		1200	HX-N25380120
		stroke per 200mm	HX-N2538...
		11800	HX-N25381180
		12000	HX-N25381200

Commercial depth Gh	Depth Gz [mm]	Height H [mm]	Product code
750	720	1000	HX-N14150100
		1200	HX-N14150120
		stroke per 200mm	HX-N1415...
		11800	HX-N14151180
		12000	HX-N14151200
1050	1020	1000	HX-N14330100
		1200	HX-N14330120
		stroke per 200mm	HX-N1433...
		11800	HX-N14331180
		12000	HX-N14331200
1130	1100	1000	HX-N14380100
		1200	HX-N14380120
		stroke per 200mm	HX-N1438...
		11800	HX-N14381180
		12000	HX-N14381200

BRACING LAYOUT „S”

BRACING LAYOUT „ZZS”

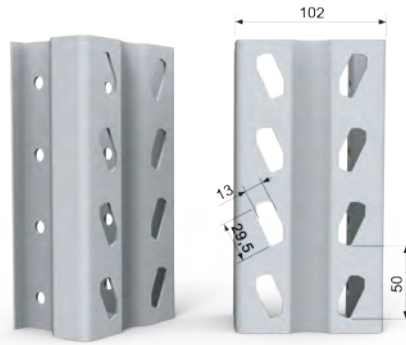
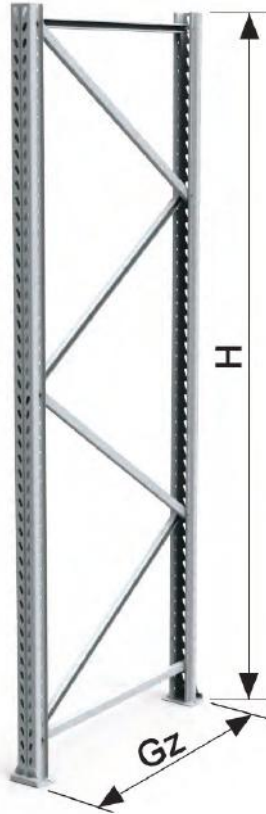

HX 102 PILLAR PROFILE

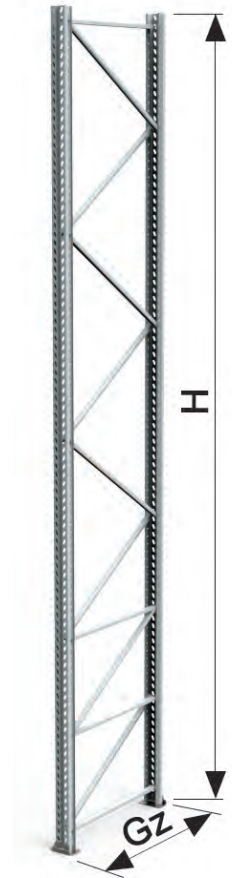

WAREHOUSE STAND: HX102 0185 BRACING LAYOUT „S”

WAREHOUSE STAND: HX102 0185 BRACING LAYOUT „ZZS”

Commercial depth Gh	Depth Gz [mm]	Height H [mm]	Product code
750	720	1000	HX-N26150100
		1200	HX-N26150120
		stroke per 200mm	HX-N2615...
		11800	HX-N26151180
		12000	HX-N26151200
1050	1020	1000	HX-N26330100
		1200	HX-N26330120
		stroke per 200mm	HX-N2633...
		11800	HX-N26331180
		12000	HX-N26331200
1130	1100	1000	HX-N26380100
		1200	HX-N26380120
		stroke per 200mm	HX-N2638...
		11800	HX-N26381180
		12000	HX-N26381200

Commercial depth Gh	Depth Gz [mm]	Height H [mm]	Product code
750	720	1000	HX-N15150100
		1200	HX-N15150120
		stroke per 200mm	HX-N1515...
		11800	HX-N15151180
		12000	HX-N15151200
1050	1020	1000	HX-N15330100
		1200	HX-N15330120
		stroke per 200mm	HX-N1533...
		11800	HX-N15331180
		12000	HX-N15331200
1130	1100	1000	HX-N15380100
		1200	HX-N15380120
		stroke per 200mm	HX-N1538...
		11800	HX-N15381180
		12000	HX-N15381200

BRACING LAYOUT „S”

BRACING LAYOUT „ZZS”

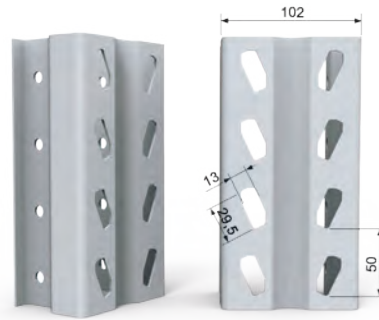
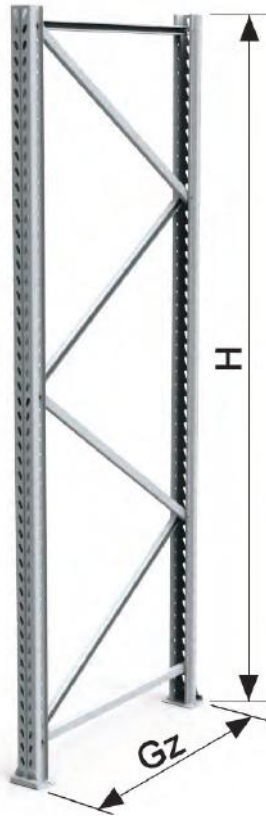

HX 102 PILLAR PROFILE

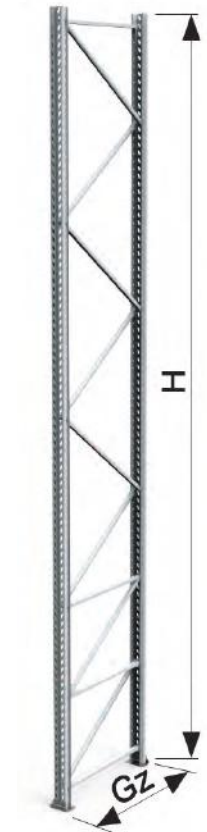

WAREHOUSE STAND: HX102 0220 BRACING LAYOUT „S”

WAREHOUSE STAND: HX102 0220 BRACING LAYOUT „ZZS”

Commercial depth Gh	Depth Gz [mm]	Height H [mm]	Product code
750	720	1000	HX-N21150100
		1200	HX-N21150120
		stroke per 200mm	HX-N2115...
		11800	HX-N21151180
		12000	HX-N21151200
1050	1020	1000	HX-N21330100
		1200	HX-N21330120
		stroke per 200mm	HX-N2133...
		11800	HX-N21331180
		12000	HX-N21331200
1130	1100	1000	HX-N21380100
		1200	HX-N21380120
		stroke per 200mm	HX-N2138...
		11800	HX-N21381180
		12000	HX-N21381200

Commercial depth Gh	Depth Gz [mm]	Height H [mm]	Product code
750	720	1000	HX-N10150100
		1200	HX-N10150120
		stroke per 200mm	HX-N1015...
		11800	HX-N10151180
		12000	HX-N10151200
1050	1020	1000	HX-N10330100
		1200	HX-N10330120
		stroke per 200mm	HX-N1033...
		11800	HX-N10331180
		12000	HX-N10331200
1130	1100	1000	HX-N10380100
		1200	HX-N10380120
		stroke per 200mm	HX-N1038...
		11800	HX-N10381180
		12000	HX-N10381200

BRACING LAYOUT „S”

BRACING LAYOUT „ZZS”

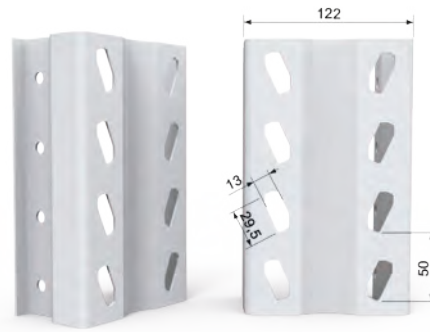
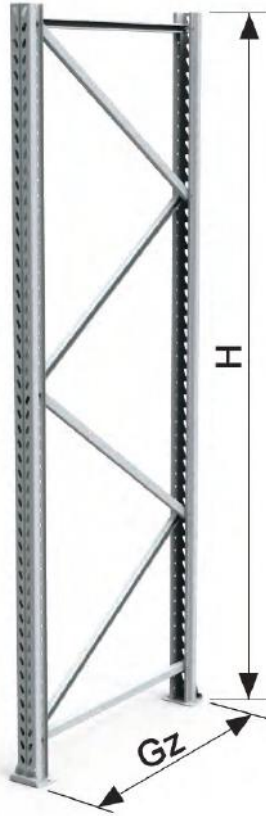

HX 122 PILLAR PROFILE

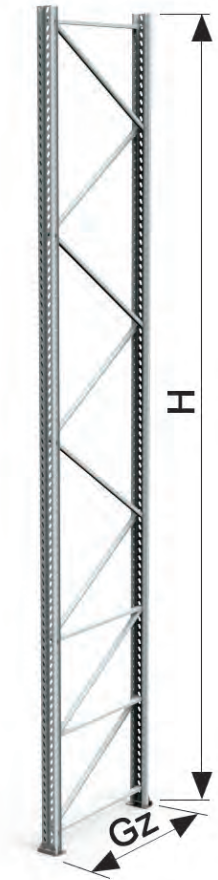

WAREHOUSE STAND: HX122 0220 BRACING LAYOUT „S”

WAREHOUSE STAND: HX122 0220 BRACING LAYOUT „ZZS”

Commercial depth Gh	Depth Gz [mm]	Height H [mm]	Product code
750	720	1000	HX-N22150100
		1200	HX-N22150120
		stroke per 200mm	HX-N2215...
		11800	HX-N22151180
		12000	HX-N22151200
1050	1020	1000	HX-N22330100
		1200	HX-N22330120
		stroke per 200mm	HX-N2233...
		11800	HX-N22331180
		12000	HX-N22331200
1130	1100	1000	HX-N22380100
		1200	HX-N22380120
		stroke per 200mm	HX-N2238...
		11800	HX-N22381180
		12000	HX-N22381200

Commercial depth Gh	Depth Gz [mm]	Height H [mm]	Product code
750	720	1000	HX-N11150100
		1200	HX-N11150120
		stroke per 200mm	HX-N1115...
		11800	HX-N11151180
		12000	HX-N11151200
1050	1020	1000	HX-N11330100
		1200	HX-N11330120
		stroke per 200mm	HX-N1133...
		11800	HX-N11331180
		12000	HX-N11331200
1130	1100	1000	HX-N11380100
		1200	HX-N11380120
		stroke per 200mm	HX-N1138...
		11800	HX-N11381180
		12000	HX-N11381200

LEVELLING SHIM UNDER THE FRAME'S FOOT

FOOT SCREWED TO THE UPRIGHT



Product code - foot	Upright
HX-A00020082	HX82
HX-A00020102	HX102
HX-A00020122	HX122

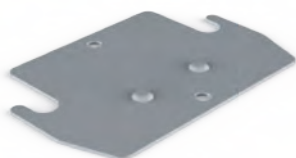

MOUNTED UNDER THE HX (82) FRAME

Component code	Thickness [mm]
HX-A00090012	1,2
HX-A00090020	2,0



MOUNTED UNDER THE HX (102) FRAME

Component code	Thickness [mm]
HX-A00100012	1,0
HX-A00100013	3,0



MOUNTED UNDER THE HX (122) FRAME

Component code	Thickness [mm]
HX-A00110012	1,0
HX-A00110020	2,0



UPRIGHT PLUG

	For frame HX82	For frame HX102	For frame HX122
Upright plug	HX-A00790082	HX-A00790102	HX-A00790122
Screw M8x...	NO-A03008065	NO-A03008085	NO-A03008105
Nut M8	NO-A20008000	NO-A20008000	NO-A20008000



ANCHOR

Component code
NO-000000105-50

WAREHOUSE STAND TO BOTTOM CROSSBEAM



STAND TO BOTTOM CROSSBEAM HX102
0220 BRACING LAYOUT „ZZS“

Commercial depth Gh	Depth Gz [mm]	Height H [mm]	Product code
600	570	3000	HX-N33060300
		stroke per 200mm	HX-N33060...
		6000	HX-N33060600
		6400	HX-N33060640
750	720	3000	HX-N33150300
		stroke per 200mm	HX-N3315....
		6000	HX-N33150600
		6400	HX-N33150640
1050	1020	3000	HX-N33330300
		stroke per 200mm	HX-N3333....
		6000	HX-N33330600
		6400	HX-N33330640



SHIM UNDER THE PILLAR STAND HX82

Component code	Thickness [mm]
HX-A00041182	1,0
HX-A00041282	2,0

STAND TO BOTTOM CROSSBEAM : HX82 BRACING LAYOUT „S“

Commercial depth Gh	Depth Gz [mm]	Height H [mm]	Product code
600	570	1000	HX-N31060100
		1200	HX-N31060120
		stroke per 200mm	HX-N3106...
		4800	HX-N31060480
		5000	HX-N31060500
750	720	1000	HX-N31150100
		1200	HX-N31150120
		stroke per 200mm	HX-N3115...
		4800	HX-N31150480
		5000	HX-N31150500
800	770	1000	HX-N31180100
		1200	HX-N31180120
		stroke per 200mm	HX-N3118...
		4800	HX-N31180480
		5000	HX-N31180500
1050	1020	1000	HX-N31330100
		1200	HX-N31330120
		stroke per 200mm	HX-N3133...
		5800	HX-N31330580
		6000	HX-N31330600

STAND TO BOTTOM CROSSBEAM: HX82
BRACING LAYOUT „ZZS“

Commercial depth Gh	Depth Gz [mm]	Height H [mm]	Product code
1050	1020	1000	HX-N32330100
		1200	HX-N32330120
		stroke per 200mm	HX-N3233...
		5800	HX-N32330580
		6000	HX-N32330600

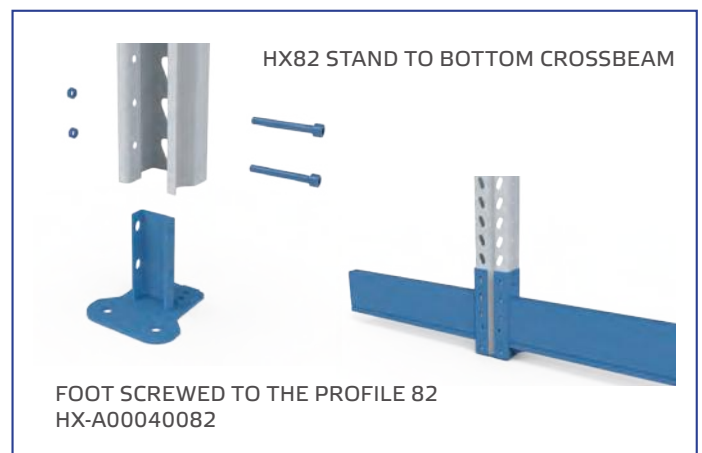

CROSSBEAMS STRUCTURAL FEATURES

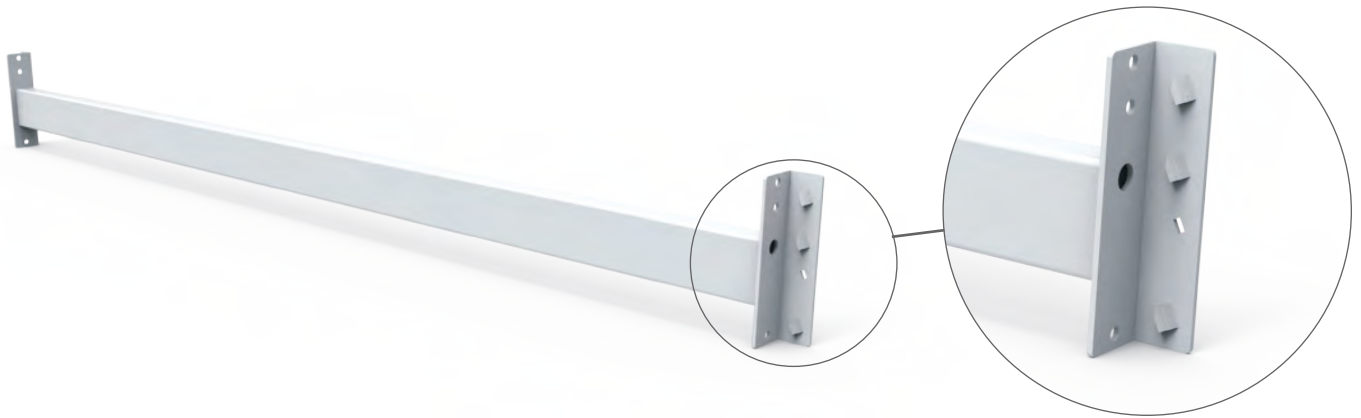

Crossbeams are profiled steel elements dedicated to mounting on rack stands to form the basis of a shelf. Depending on required usable properties, we are offering various dimensions and shapes of carrying beam section. Each crossbeam terminates in clamping grips that allow wedgetype mounting to the frame pillar's perforation. Additionally, owing to high rigidity of crossbeams pillar clamping, longitudinal stability of racks has been provided. Along with an increasing load on a pair of crossbeams, rigidity of crossbeams pillar clamping is enhanced.

Depending on dimensions of a section of an applied beam profile, joints (claws) with a height of 199 mm or 249 mm are used, labelled respectively as "200" or "250".

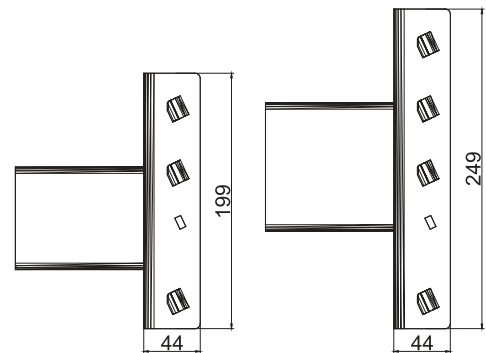

In order to prevent accidental pull-up and extension of crossbeams by transporting devices, protective elements are obligatorily used. MX-A00010053.

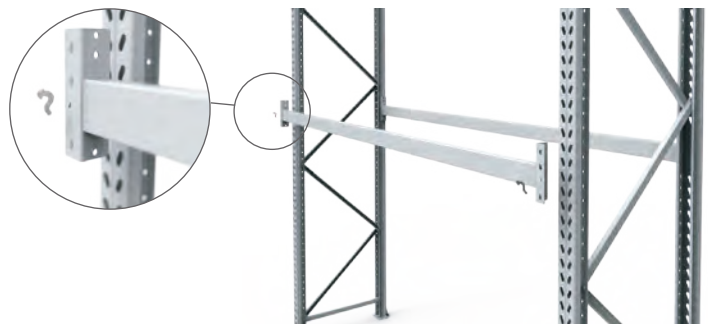



Depending on required usable properties, we are offering various dimensions and shapes of carrying beam section.

Labelling of crossbeam types, e.g.: **5N060**

- the first digit means the width of a crossbeam [cm]
- the subsequent letter marks the type of a crossbeam (N - stepped section, S - rectangular, standard section, C - complex beam)
- the subsequent number marks the height of a crossbeam [mm]

CROSSBEAMS WITH A CLOSED SECTION „S”

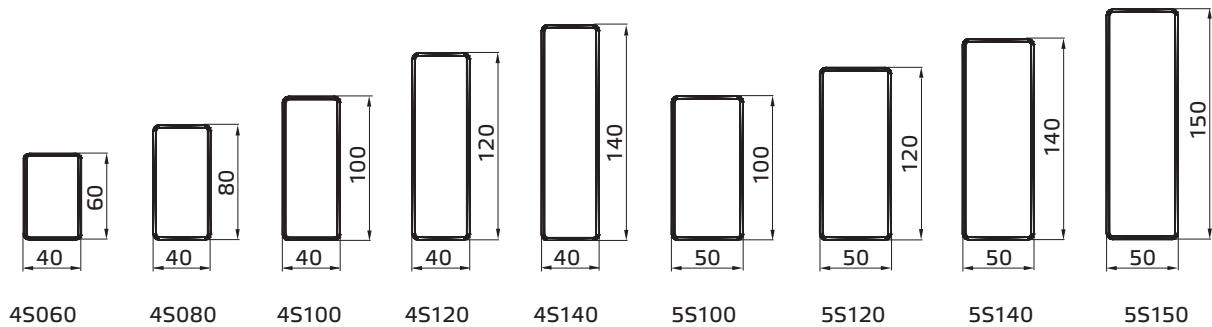

CROSSBEAMS WITH A BUILT-UP PROFILE „C”

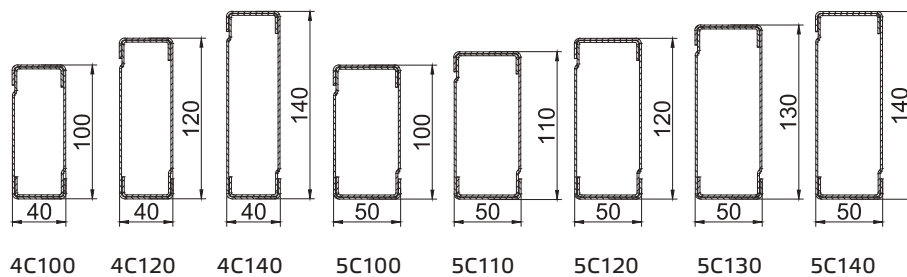

CROSSBEAMS WITH A STEPPED SECTION „N”

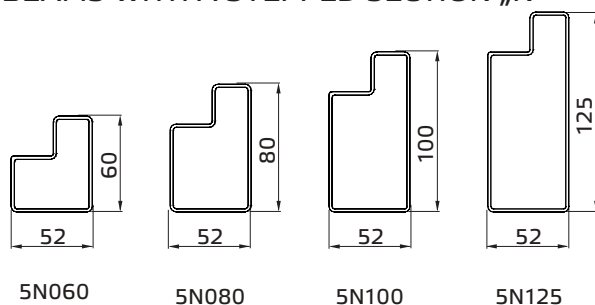

CENTRAL CROSSBEAMS

Type of crossbeam	Upright	Grip height [mm]	Commercial length	Component code	Available coatings
STORAGE OF 2 EUROPALLETS					
4S060	60x40	200	L-1800	HX-T02011800	Power coating, hotdip galvanization
4S080	80x40	200		HX-T02021800	
4S100	100x40	250		HX-T03041800	
4S120	120x40	250		HX-T03051800	
4S140	140x40	250		HX-T03061800	
4C100	100x40	250		HX-T03231800	Powder coating
4C120	120x40	250		HX-T03241800	
5C100	100x50	250		HX-T03521800	
5C110	110x50	250		HX-T03531800	
5C120	120x50	250		HX-T03541800	
5C130	130x50	250		HX-T03551800	
5C140	140x50	250		HX-T03561800	
5N060	60x52	200		HX-T02411800	Power coating, hotdip galvanization
5N080	80x52	200		HX-T02421800	
5N125	125x52	250		HX-T03441800	
STORAGE OF 3 EUROPALLETS					
4S060	60x40	200	L-2700	HX-T02012700	Power coating, hotdip galvanization
4S080	80x40	200		HX-T02022700	
4S100	100x40	250		HX-T03042700	
4S120	120x40	250		HX-T03052700	
4S140	140x40	250		HX-T03062700	
5S140	140x50	250		HX-T03302700	Powder coating
5S150	150x50	250		HX-T03312700	
4C100	100x40	250		HX-T03232700	
4C120	120x40	250		HX-T03242700	
5C100	100x50	250		HX-T03522700	
5C110	110x50	250		HX-T03532700	
5C120	120x50	250		HX-T03542700	
5C130	130x50	250		HX-T03552700	
5C140	140x50	250		HX-T03562700	
5N060	60x52	200		HX-T02412700	Power coating, hotdip galvanization
5N080	80x52	200	HX-T02422700		
5N125	125x52	250	HX-T03442700		
STORAGE OF 4 EUROPALLETS					
4S060	60x40	200	L-3600	HX-T02013600	Power coating, hotdip galvanization
4S080	80x40	200		HX-T02023600	
4S100	100x40	250		HX-T03043600	
4S120	120x40	250		HX-T03053600	
4S140	140x40	250		HX-T03063600	
5S140	140x50	250		HX-T03303600	Powder coating
5S150	150x50	250		HX-T03313600	
4C100	100x40	250		HX-T03233600	
4C120	120x40	250		HX-T03243600	
5C100	100x50	250		HX-T03523600	
5C110	110x50	250		HX-T03533600	
5C120	120x50	250		HX-T03543600	
5C130	130x50	250		HX-T03553600	
5C140	140x50	250		HX-T03563600	
5N060	60x52	200		HX-T02413600	Power coating, hotdip galvanization
5N080	80x52	200	HX-T02423600		
5N125	125x52	250	HX-T03443600		

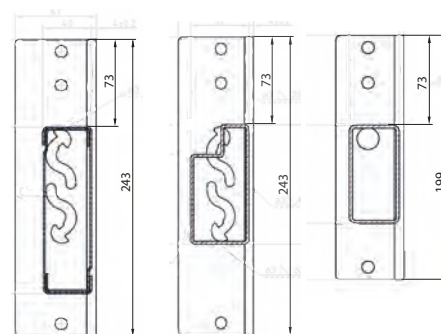

Important note!

It is necessary to order two safeguards MX-A00010053 per one crossbeam (one per each claw).

BOTTOM CROSSBEAM

Type of crossbeam	Upright	Grip height [mm]	Commercial length	Component code	Available coatings
STORAGE OF 2 EUROPALLETS					
4S060	60x40	200	L-1800	HX-T04011800	Power coating, hotdip galvanization
4S080	80x40	200		HX-T04021800	
4S100	100x40	250		HX-T05041800	
4C100	100x40	250		HX-T05231800	Powder coating
5C100	100x50	250		HX-T05521800	
5C140	140x50	250		HX-T05561800	
5N060	60x52	200		HX-T04411800	Power coating, hotdip galvanization
5N080	80x52	200		HX-T04421800	
5N125	125x52	250		HX-T05441800	
STORAGE OF 3 EUROPALLETS					
4S060	60x40	200	L-2700	HX-T04012700	Power coating, hotdip galvanization
4S080	80x40	200		HX-T04022700	
4S100	100x40	250		HX-T05042700	
4C100	100x40	250		HX-T05232700	Powder coating
4C120	120x40	250		HX-T05242700	
5C100	100x50	250		HX-T05522700	
5C110	110x50	250		HX-T05532700	
5C120	120x50	250		HX-T05542700	
5C130	130x50	250		HX-T05552700	
5C140	140x50	250		HX-T05562700	
5N060	60x52	200	HX-T04412700	Power coating, hotdip galvanization	
5N080	80x52	200	HX-T04422700		
5N125	125x52	250	HX-T05442700		
STORAGE OF 4 EUROPALLETS					
4S060	60x40	200	L-3600	HX-T04013600	Power coating, hotdip galvanization
4S080	80x40	200		HX-T04023600	
4S100	100x40	250		HX-T05043600	
4S120	120x40	250		HX-T05053600	
4S140	140x40	250		HX-T05063600	
5S150	150x50	250		HX-T05313600	
4C100	100x40	250		HX-T05233600	Powder coating
4C120	120x40	250		HX-T05243600	
5C100	100x50	250		HX-T05523600	
5C110	110x50	250		HX-T05533600	
5C120	120x50	250	HX-T05543600		
5C130	130x50	250	HX-T05553600		
5C140	140x50	250	HX-T05563600		

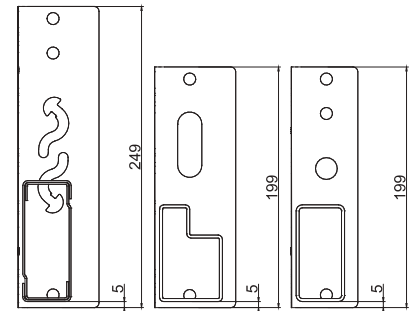

Important note!

It is necessary to order two safeguards MX-A00010053 per one Crossbeam (one per each claw).



NUMBERING OF RACK ROWS AND RACKS

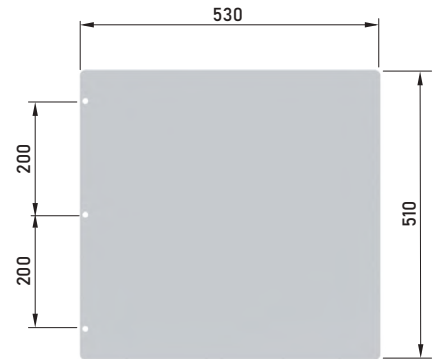

SHEET FOR MARKING RACK ROWS 500X500 WITH SCREWS

Dimension [mm]	Component code
500 x 500	HX-A03435050



SHEET FOR MARKING RACK ROWS FOR HX G-1130

Dimension H [mm]	Component code
400	HX-A03401130

PALLET SAFETY BACK STOP

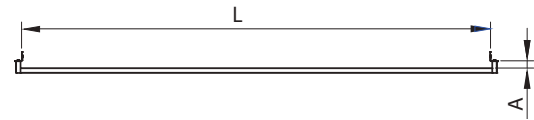

PALLET SAFETY BACK STOP

Commercial depth Gh	Dimension A [mm]	Length L [mm]	Component code
PALLET SAFETY BACK STOP Gh=750			
750	40	1800	MX-Z00021800
		2700	MX-Z00022700
		3600	MX-Z00023600
PALLET SAFETY BACK STOP Gh=1050			
1050	97	1800	MX-Z00011800
		2700	MX-Z00012700
		3600	MX-Z00013600
PALLET SAFETY BACK STOP Gh=1130			
1130	50	1800	MX-Z00071800
		2700	MX-Z00072700
		3600	MX-Z00073600

PALLET SAFETY SIDE STOP H-500

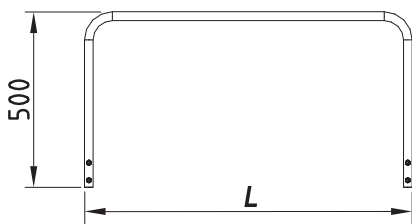

Commercial depth Gh	Dimension L [mm]	Component code	Screw
HX82 PALLET SAFETY SIDE STOP Gh=...			
750	635	HX-Z00030750	M8x90
1050	935	HX-Z00031050	M8x90
1130	1015	HX-Z00031130	M8x90
HX102 PALLET SAFETY SIDE STOP Gh=...			
750	635	HX-Z00040750	M8x110
1050	935	HX-Z00041050	M8x110
1130	1015	HX-Z00041130	M8x110
HX122 PALLET SAFETY SIDE STOP Gh=...			
750	635	HX-Z00050750	M8x140
1050	935	HX-Z00051050	M8x140
1130	1015	HX-Z00051130	M8x140

HX 82 BRACKET FOR PROTECTIVE GRATE UNIVERSAL (LEFT/RIGHT)

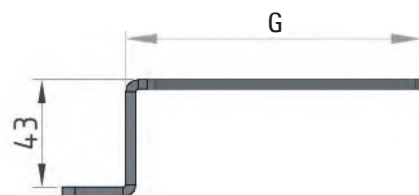

Dimension G [mm]	Component code
79	HX-A02250080
119	HX-A02250120

HX 102 BRACKET FOR PROTECTIVE GRATE UNIVERSAL (LEFT/RIGHT)

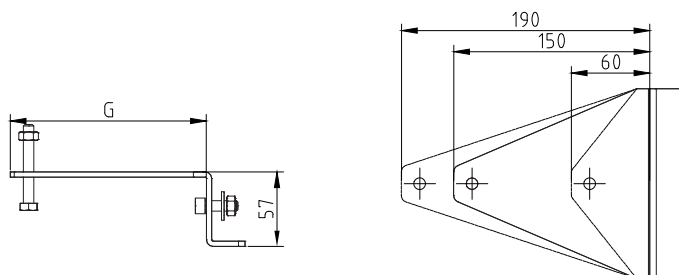

Dimension G [mm]	Component code
60	MX-A01030060
150	MX-A01030150
190	MX-A01030190

PROTECTIVE GRATE HX 102 H-500 L=...

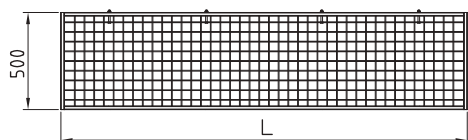
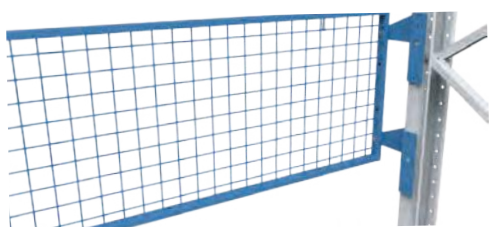

Commercial length Gh	Dimension LK (mm)	H grate (mm)	Component code
HX 82			
1800	1875	600	HX-A02211875
2700	2775	600	HX-A02212775
3600	3675	600	HX-A02213675
HX 102			
1800	1890	500	MX-A01001800
2700	2790	500	MX-A01002700
3600	3690	500	MX-A01003600

CROSSBARS

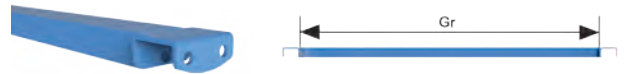

BAR FOR 4S AND 4C CROSSBEAMS

BAR FOR 5S AND 5C CROSSBEAMS

Frame Gh	Beam Gr [mm]	Component code
750	627	MR-B00010750
1050	927	MR-B00011050
1130	1007	MR-B00011130

Frame Gh	Beam Gr [mm]	Component code
750	607	MR-B00110750
1050	907	MR-B00111050
1130	987	MR-B00111130

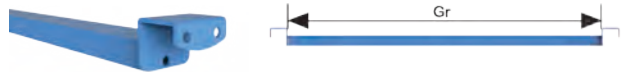

BAR UNDER AN 18 MM SLAB FOR 4S AND 4C CROSSBEAMS

BAR UNDER AN 18 MM SLAB FOR 5C CROSSBEAMS

Frame Gh	Beam Gr [mm]	Component code
G-750	L-627	MR-B00050750
G-1050	L-927	MR-B00051050
G-1130	L-1007	MR-B00051130

Frame Gh	Beam Gr [mm]	Component code
G-750	L-607	MR-B00150750
G-1050	L-907	MR-B00151050
G-1130	L-987	MR-B00151130

BRACING OF PARALLEL ALLEYS

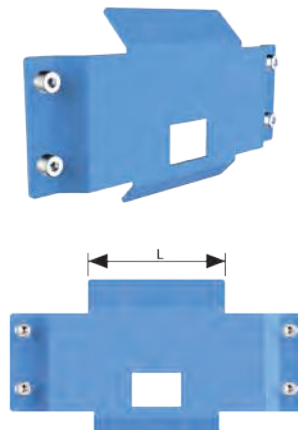

Dimension [mm]	Component code
L-50	HX-S0100050
L-100	HX-S01000100
L-120	HX-S01000120
L-200	HX-S01000200
L-300	HX-S01000300
L-500	HX-S01000500
L-700	HX-S01000700
L-1000	HX-S01001000

A spine bracing consists of two tension members attached to two adjacent frames in a plane perpendicular to the floor. The spine braces should intersect at an angle as close to 90° as possible. They must grip the frames at 60% of the frame height or higher, which means that a segment can need more than one pair of spine braces. The need for spine bracing and the bracing design and installation methods are specified in each instance in the design.

VERTICAL REINFORCE

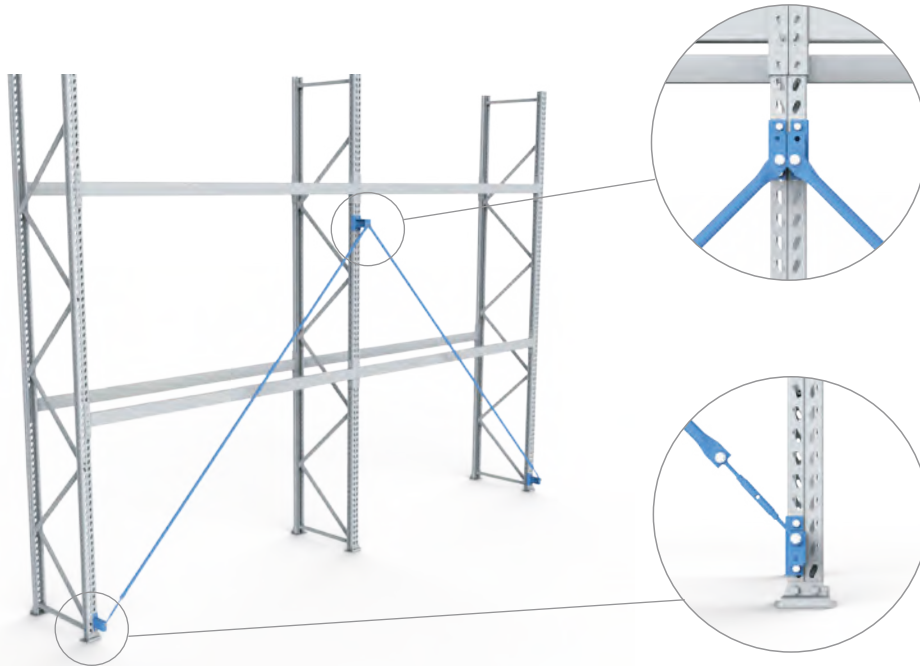

FOR A RACK WITH AN HX FRAME (82)

Module length [mm]	Component code
L-1800	HX-A02801800
L-2700	HX-A02802700
L-3600	HX-A02803600

FOR A RACK WITH AN HX FRAME (102)

Module length [mm]	Component code
L-1800	HX-A02901800
L-2700	HX-A02902700
L-3600	HX-A02903600

HORIZONTAL REINFORCE

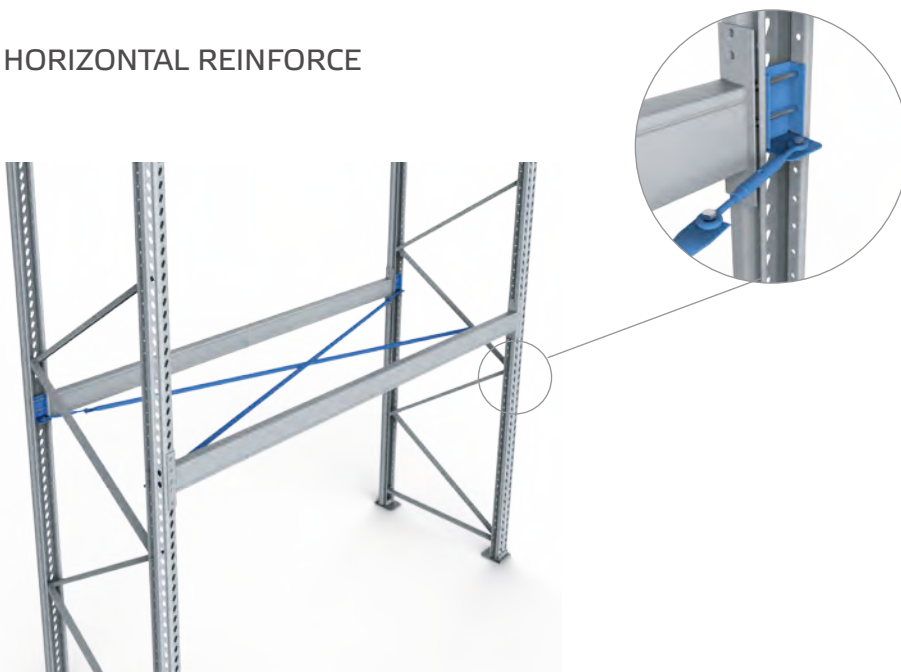

FOR A RACK WITH AN HX(82) FRAME

Frame depth [mm]	Module length [mm]	Component code
G-1130	L-1800	HX-A14381800
G-1130	L-2700	HX-A14382700
G-1130	L-3600	HX-A14383600

FOR A RACK WITH AN HX(102) FRAME

Frame depth [mm]	Module length [mm]	Component code
G-1130	L-1800	HX-A10391800
G-1130	L-2700	HX-A10392700
G-1130	L-3600	HX-A10393600

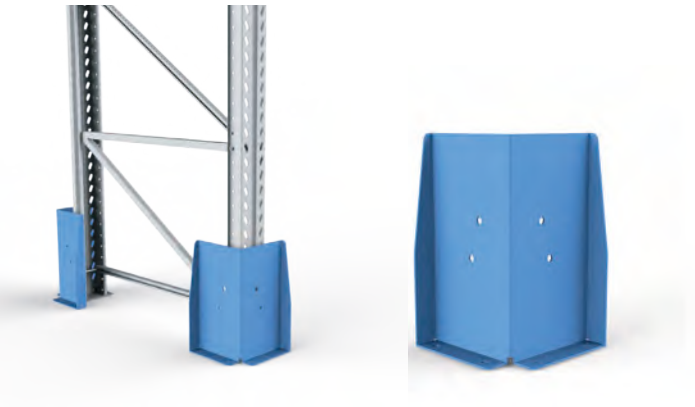

FRONT UPRIGHT GUARD

CORNER UPRIGHT GUARD

Dimension [mm]	Frame	Component code
H - 400	82	HX-A16130082
H - 400	102	HX-A16130102
H - 400	122	HX-A16130122

Dimension [mm]	Component code
H - 400	HX-A01580400



Fender beam with a 140x40 mm profile for a front guard, HX-A1624....

Fender beam with a 140x40 mm profile for a corner guard, MR-A0334...

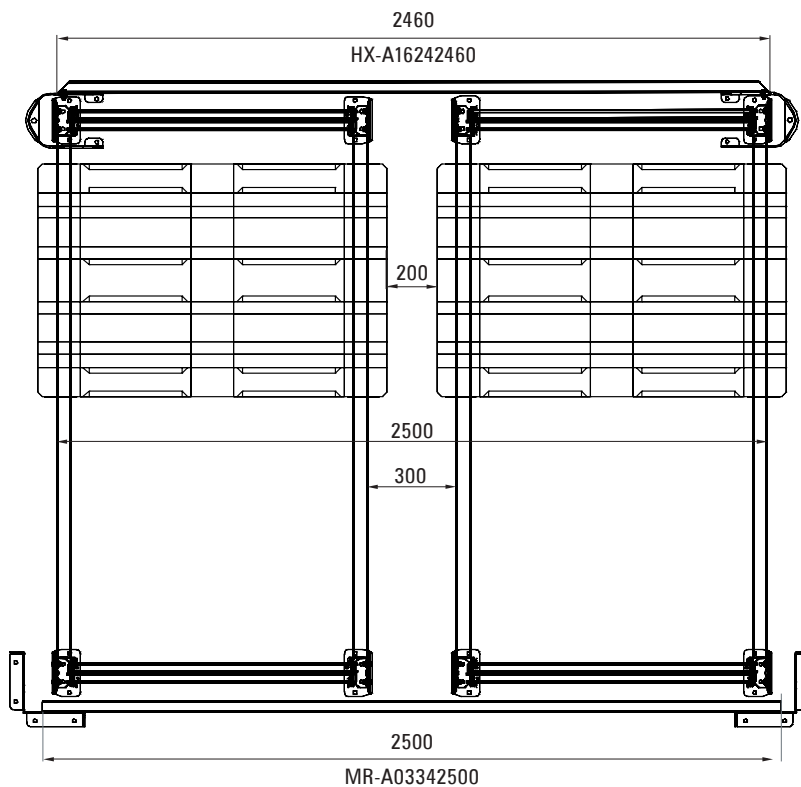

Example of using corner and front guard with fender beams

LATERAL SHELF REINFORCED

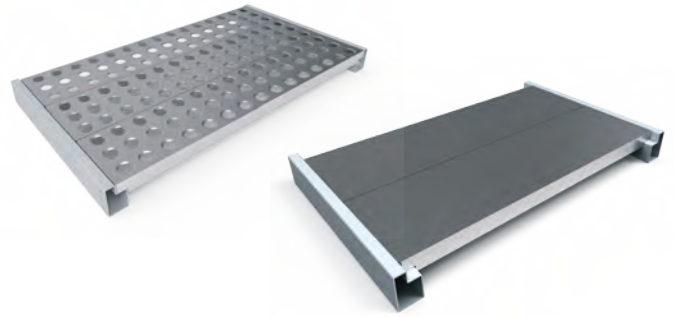
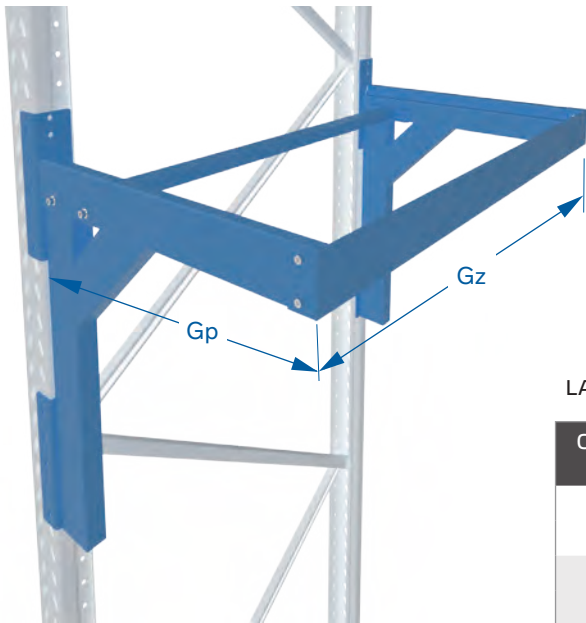

LATERAL SHELF | PERFORATED PANELS

Commercial depth Gh	Dimension Gz [mm]	Lenght Gp [mm]	Component code H [mm]	Code
630	600	440	1 pcs: Frame	MX-A05252440-....
			2 pcs: Perf. Panel 217	MR-P40220630-50
930	900	440	1 pcs: Frame	MX-A05251440-....
			2 pcs: Perf. Panel 217	MR-P40220930-50
1050	1020	570	1 pcs: Frame	MX-A05250570-....
			3pcs: Perf. Panel 186	MR-P40191050-50

LATERAL SHELF | PLAIN PANELS

630	600	440	1 pcs: Frame	MX-A05252440-...
			2 pcs: Plain Panel 217	MR-P42220630-...
930	900	440	1 pcs: Frame	MX-A05251440-...
			2 pcs: Plain Panel 217	MR-P42220930-...
1050	1020	570	1 pcs : Frame	MX-A05250570-...
			3pcs: Plain Panel 186	MR-P42191050- ...



PALLET TERMINAL

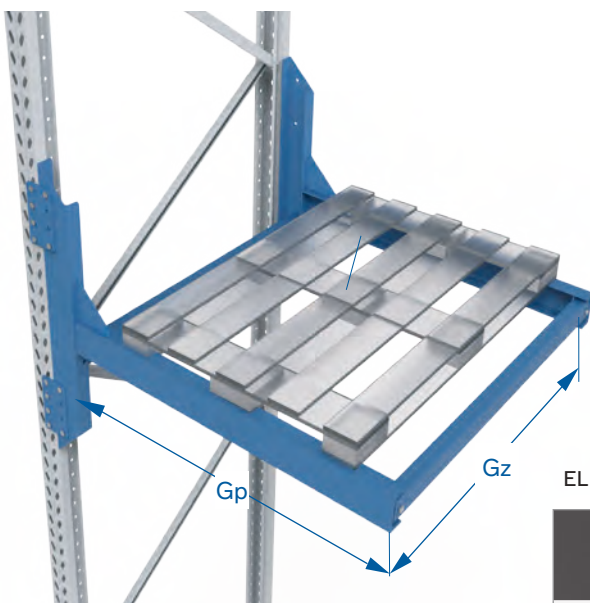

ELEMENTS UNDER FRAME HX (82)

Commercial depth Gh	Dimension Gz [mm]	Lenght Gp [mm]	Component code	Code
1130	1100	1000	1 pcs: Frame	HX-A06253800

* terminal load affects global stability, therefore the configuration should be recalculated each time

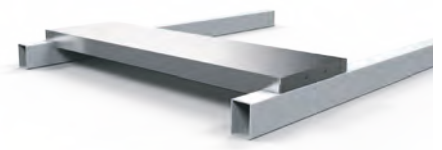
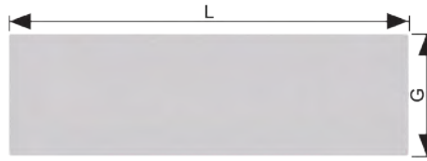

PLAIN PANEL SHELF FOR A 50X... RECTANGULAR CROSSBEAM

PLAIN PANEL SHELF FOR A 40X... RECTANGULAR CROSSBEAM

Commercial depth	Shelf length L [mp]	Shelf load max [kg]	Shelf width G [mm]	Component code
750	718	70	186	MR-P38190750
			217	MR-P38220750
1050	1018	40	186	MR-P38191050
			217	MR-P38221050
1130	1098	40	186	MR-P38191130
			217	MR-P38221130

Commercial depth	Shelf length L [mp]	Shelf load max [kg]	Shelf width G [mm]	Component code
750	718	70	217	MR-P02220750
			186	MR-P02190750
1050	1018	40	217	MR-P02221050
			186	MR-P02191050
1130	1098	40	217	MR-P02221130
			186	MR-P02191130

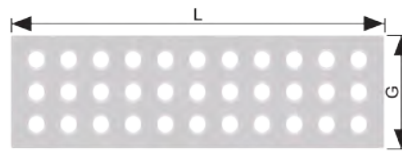

PERF. PANEL SHELF FOR A 50X...RECTANGULAR CROSSBEAM

PERF. PANEL SHELF FOR A 40X... RECTANGULAR CROSSBEAM

Commercial depth	Shelf length L [mp]	Shelf load max [kg]	Shelf width G [mm]	Component code
750	718	70	217	MR-P39220750
			186	MR-P39190750
1050	1018	40	217	MR-P39221050
			186	MR-P39191050
1130	1098	40	217	MR-P39221130
			186	MR-P39191130

Commercial depth	Shelf length L [mp]	Shelf load max [kg]	Shelf width G [mm]	Component code
750	718	70	217	MR-P41220750
			186	MR-P41190750
1050	1018	40	217	MR-P41221050
			186	MR-P41191050
1130	1098	40	217	MR-P41221130
			186	MR-P41191130



PLAIN PANEL SHELF FOR A 52X... STEPPED CROSSBEAM

PERFORATED PANEL SHELF FOR A 2X... STEPPED CROSSBEAM

Commercial depth	Shelf length L [mp]	Shelf load max [kg]	Shelf width G [mm]	Component code
750	668.5	80	217	MR-P42220750
			186	MR-P42190750
1050	965	50	217	MR-P42221050
			186	MR-P42191050
1130	1045	40	217	MR-P42221130
			186	MR-P42191130

Commercial depth	Shelf length L [mp]	Shelf load max [kg]	Shelf width G [mm]	Component code
750	668.5	80	217	MR-P40220750
			186	MR-P40190750
1050	965	50	217	MR-P40221050
			186	MR-P40191050
1130	1045	40	217	MR-P40221130
			186	MR-P40191130

METHOD OF SELECTING A NUMBER OF PANEL SHELVES TO CROSSBEAMS OF A CORRESPONDING LENGTH

Crossbeam lengths L	A 186 mm wide shelf	A 217 mm wide shelf
1800	6	3
2700	12	2
3600	11	7

PLATFORM GRATING

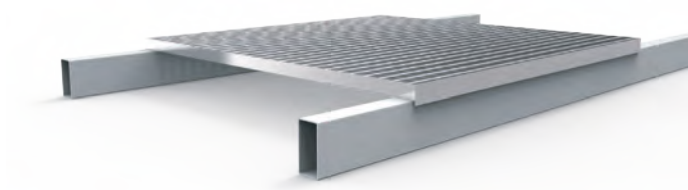
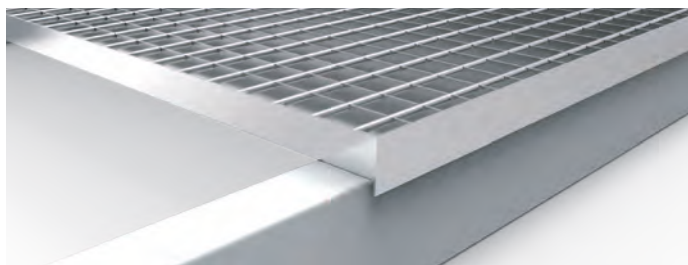
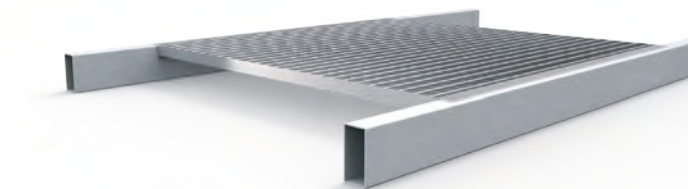

PLATFORM GRATING WITH AN ANGLE FOR 50X... CROSSBEAMS

Crossbeam length	Number of items necessary for shelving	Load on a single grate per [kg/m ²]	Component code
G - 750			
1800	2	1500	AA-000490203-52
2700	3		
3600	4		
G - 1050			
1800	2	1200	AA-000490202-52
2700	3		
3600	4		
G - 1130			
1800	2	1094	AA-000490201-52
2700	3		
3600	4		

PLATFORM GRATING WITH A FLAT BAR EDGE FOR 50X... CROSSBEAMS

Crossbeam lengths	Number of items necessary for shelving	Load on a single grate per [kg/m ²]	Component code
G - 750			
1800	2	1500	AA-000490104-52
2700	3		
3600	4		
G - 1050			
1800	2	1200	AA-000490072-52
2700	3		
3600	4		
G - 1130			
1800	2	1094	AA-000490070-52
2700	3		
3600	4		

MESH SHELVES FOR A RECTANGULAR CROSSBEAM

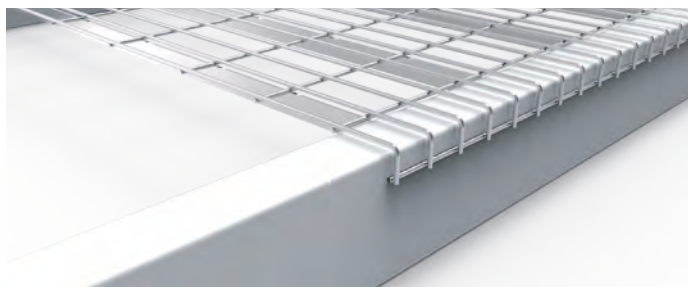

FOR 50X... RECTANGULAR CROSSBEAMS

Crossbeam lengths	Number of items necessary for shelving	Load on a single grate per [kg/m ²]	Component code
G - 750			
1800	2	400	MR-PS0000143-50
2700	3		
3600	4		
G - 1050			
1800	2	400	MR-PS0000144-50
2700	3		
3600	4		
G - 1130			
1800	2	400	MR-PS0000145-50
2700	3		
3600	4		

MESH SHELVES FOR A STEPPED CROSSBEAM

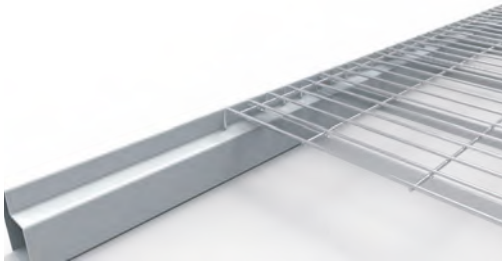

FOR STEPPED CROSSBEAMS

Crossbeam length	Number of items necessary for shelving	Load on a single grate per [kg/m ²]	Component code
G - 750			
1800	2	400	MR-PS0000146-50
2700	3		
3600	4		
G - 1050			
1800	2	400	MR-PS0000147-50
2700	3		
3600	4		
G - 1130			
1800	2	400	MR-PS0000148-50
2700	3		
3600	4		

PERFORATED SHELF

PERFORATED PANEL SHELF FOR CROSSBEAMS WITH A 40X... PROFILE AND A LENGTH L OF 890 MM



Cross-beam length	Number of items necessary for shelving	Load on a single grate	Component code for 40x...	Component code for 50x...
G - 750				
1800	2	760 kg	MR-P24890750	MR-P25890750
2700	3			
3600	4			
G - 1050				
1800	2	490 kg	MR-P24891050	MR-P25891050
2700	3			
3600	4			
G - 1130				
1800	2	420 kg	MR-P24891130	MR-P25891130
2700	3			
3600	4			

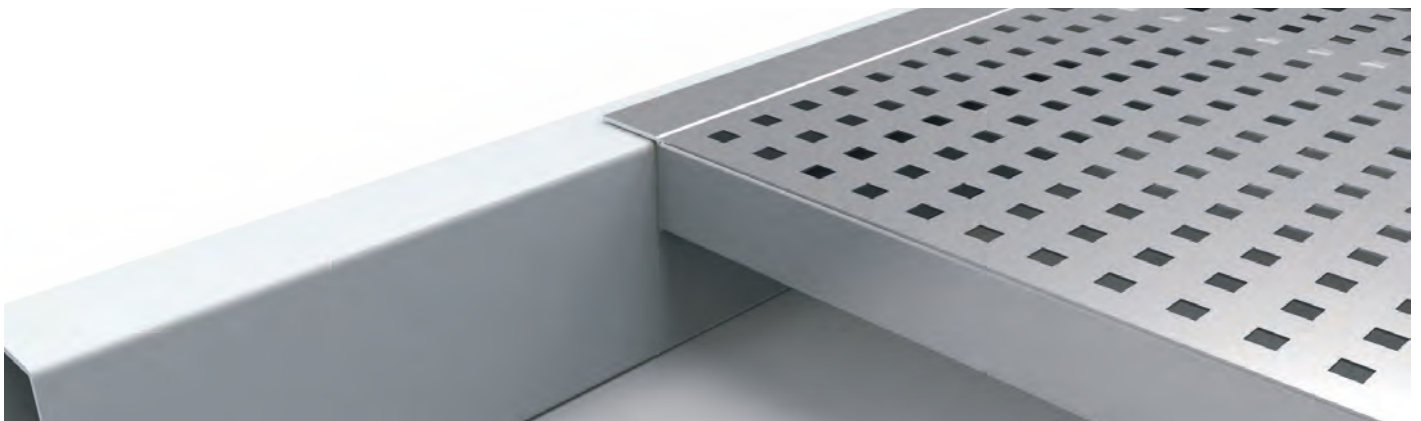

INTEGRATION OF STORE AND WAREHOUSE RACKS

A series of HX racks, mainly used for fitting high storage warehouses, can also be used to arrange sales areas. Application of relevant series of types of frames and traverses allows building structures that constitute a functional reflection of racks used by DIY concepts or DIY discount stores. Application of a group of accessories presented further in the catalogue perfectly meets expectations concerning exposure and sales in the abovementioned facilities.

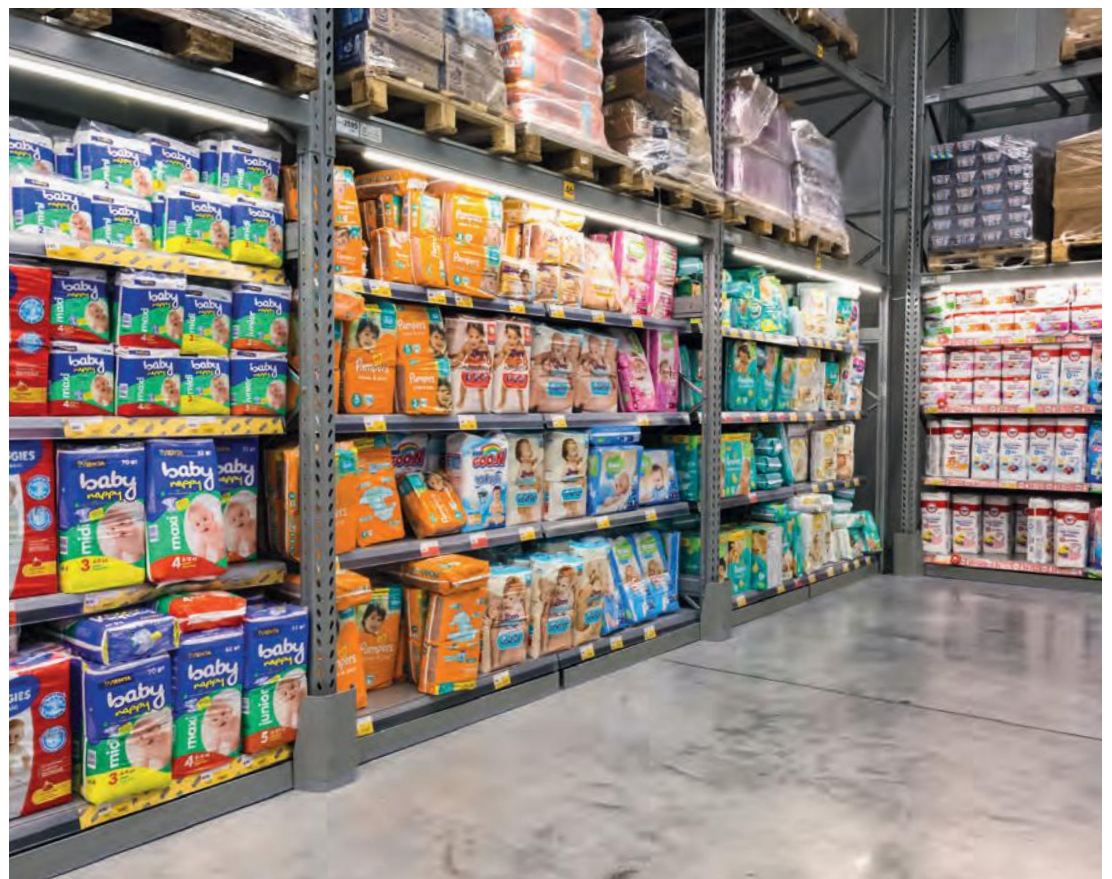

SINGLE INTEGRATION WITH REDUCE DEPTH

SINGLE INTEGRATION - FRAME 82 0185 (S) FOOTPLATE LOWER TRAVERSE

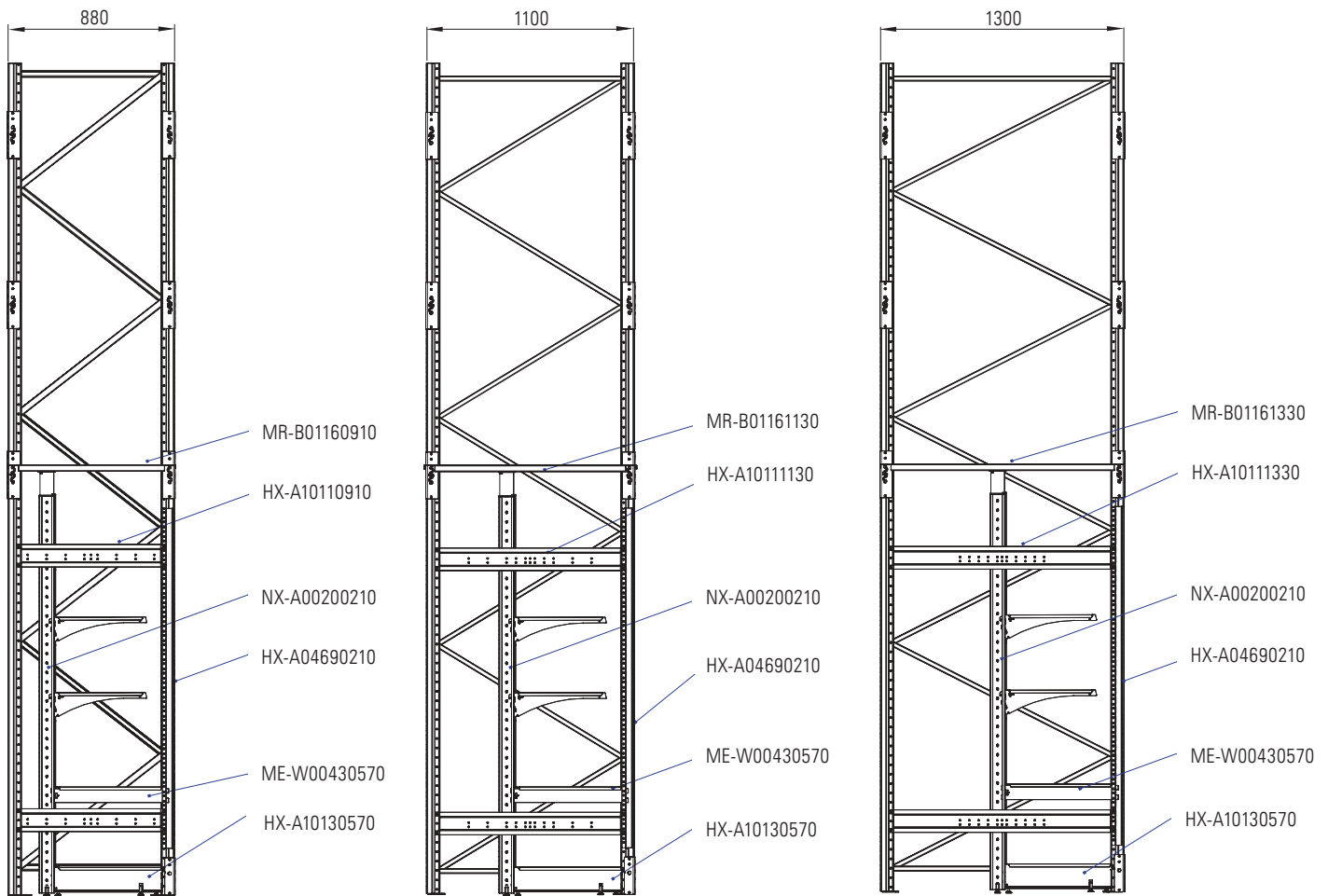

Commercial depth G	Depth Gz [mm]	Integration Gh shelf	Height H [mm]	Component code
510	480	max. 370	4400	HX-N31810440
			4600	HX-N31810460
			4800	HX-N31810480
610	580	max. 470	3400	HX-N31820340
			4400	HX-N31820440
			4600	HX-N31820460
710	680	max. 570	4800	HX-N31820480
			4400	HX-N31830440
			4600	HX-N31830460
810	780	max. 670	4800	HX-N31830480
			800	HX-N31840080
			2600	HX-N31840260
910	880	max. 770	4400	HX-N31840440
			4600	HX-N31840460
			4800	HX-N31840480
			4400	HX-N31850440
			4600	HX-N31850460

DOUBLE INTEGRATION

DOUBLE INTEGRATION 25MM – FRAME 102 0220 (ZZS) FOOTPLATE LOWER TRAVERSE

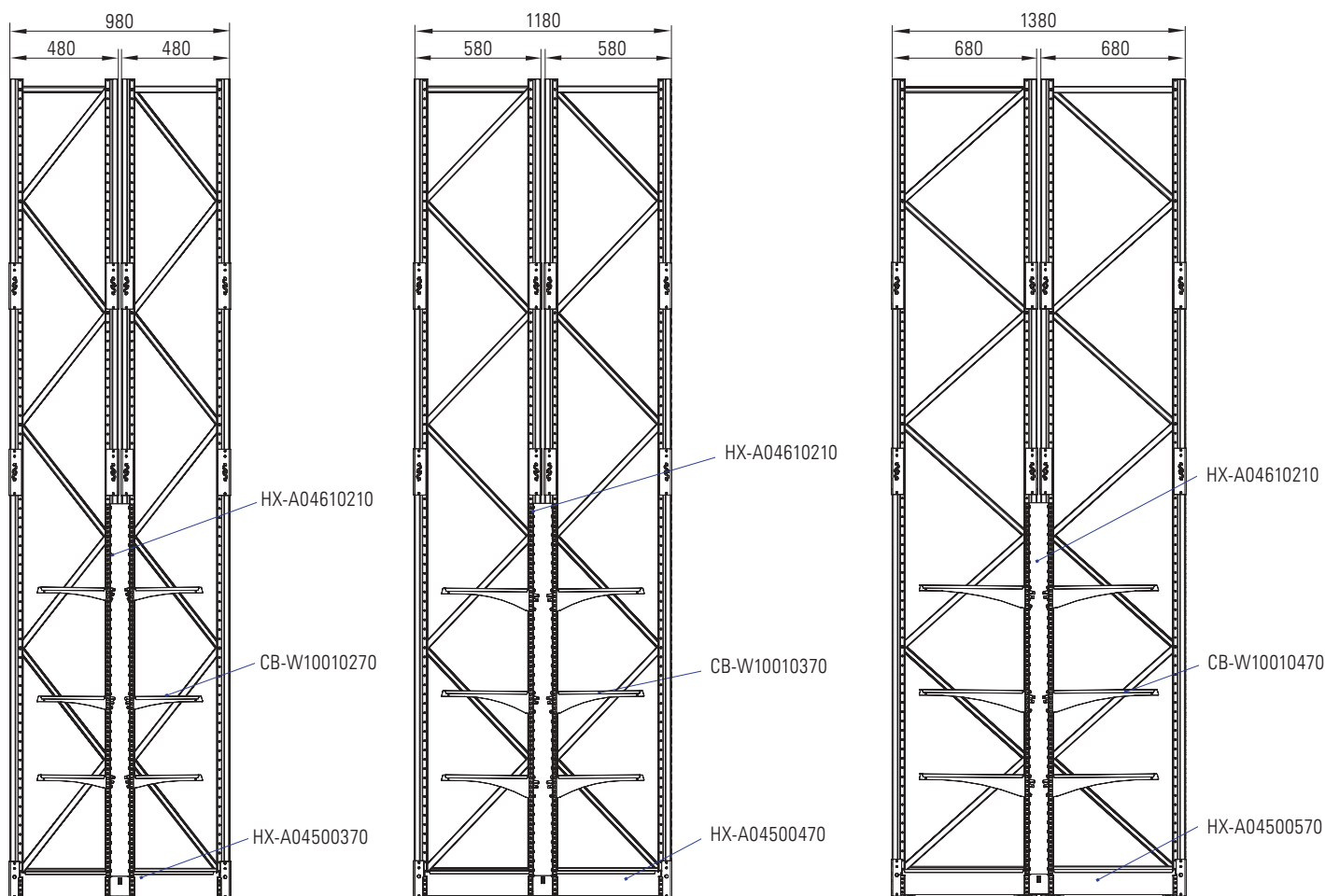

Commercial depth Gh	Depth Gz [mm]	Integration Gh shelf	Height H [mm]	Component code
510	480	max. 370	4400	HX-N33810440
610	580	max. 470	4400	HX-N33820440
710	680	max. 570	4400	HX-N33830440
810	780	max. 670	4400	HX-N33840440
910	880	max. 770	4400	HX-N33850440

TWO-SIDED INTEGRATION

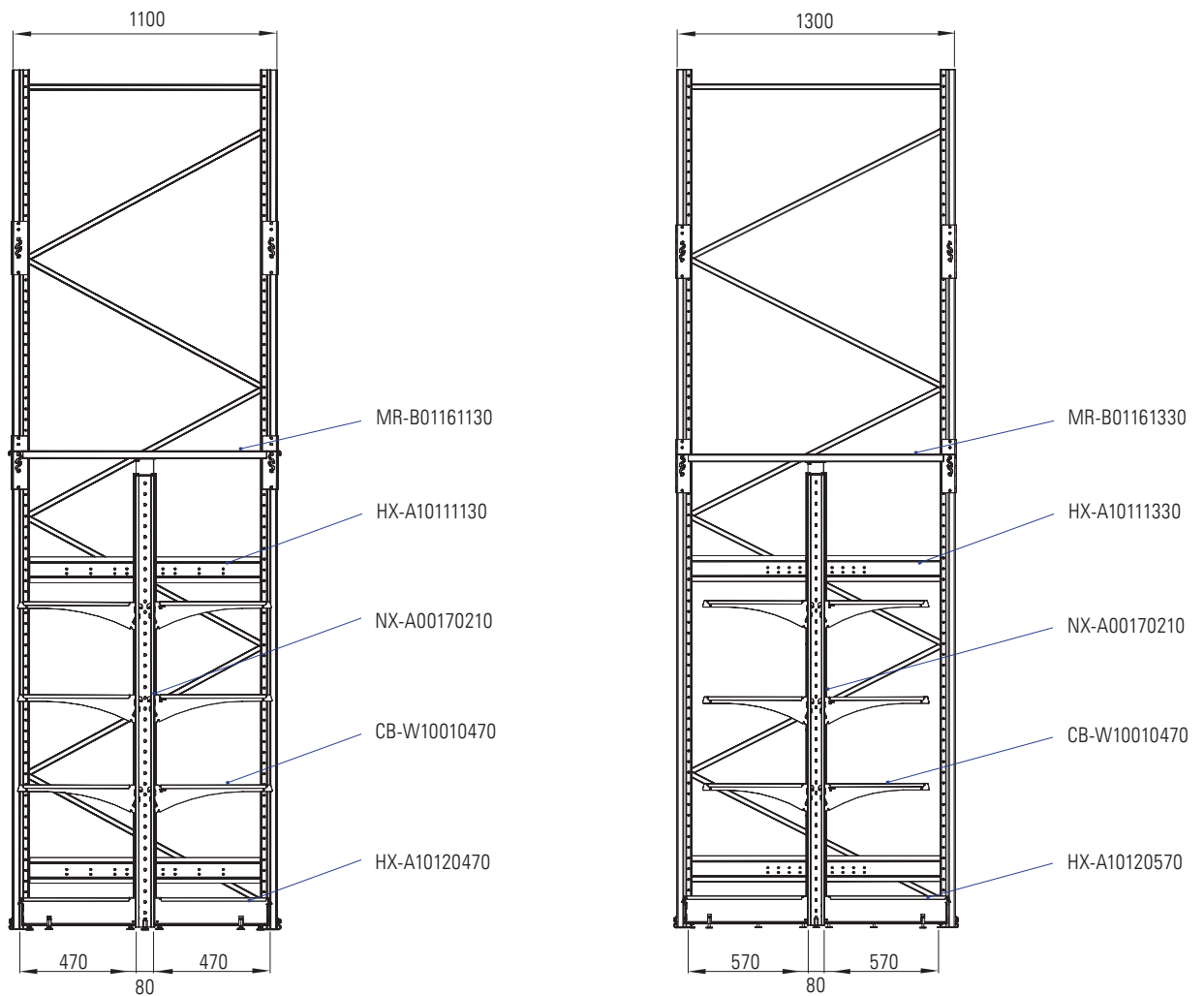

Commercial depth Gh	Depth Gz [mm]	Integration Gh shelf	Height H [mm]	Component code
HX 82 0185 (S)				
930	900	2 x 370	4000	HX-N31250400
1130	1100	2 x 470	4000	HX-N31380400
1330	1300	2 x 570	4000	HX-N31490400
HX 102 0185 (S)				
930	900	2 x 370	4200	HX-N29250420
1130	1100	2 x 470	4200	HX-N29380420
1330	1300	2 x 570	4200	HX-N29490420
HX 102 0220 (ZZS)				
930	900	2 x 370	4600	HX-N33250460
1130	1100	2 x 470	4600	HX-N33380460
1330	1300	2 x 570	4600	HX-N33490460

SINGLE INTEGRATION

FRAME WITH A REDUCE DEPTH 82 0185 (S) LOWER TRAVERSE

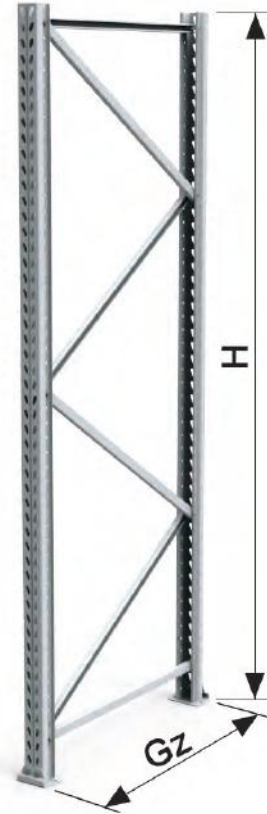

Commercial depth Gh	Depth Gz [mm]	Integration Gh shelf	Height H [mm]	Component code
HX 82 0185 (S)				
810	780	max. 670	4000	HX-N31840400
830	800	max. 670	4000	HX-N31190400
910	880	max. 570+210	4000	HX-N31850400
1050	1020	max. 670+210	4000	HX-N31330400
1130	1100	max. 670+210	4000	HX-N31380400
HX 102 0220 (ZZ5)				
810	780	max. 670	4000	HX-N33840400
830	800	max. 670	4000	HX-N33190400
910	880	max. 570+210	4000	HX-N33850400
1050	1020	max. 670+210	4000	HX-N33330400
1130	1100	max. 670+210	4000	HX-N33380400



FRAME 82 0185 (S) DOUBLE INTEGRATION 2 FRAMES

FRAME 102 0220 (ZZS) DOUBLE INTEGRATION 2 FRAMES

Commercial depth Gh	Depth Gz	Integration Gh shelf	Height H [mm]	Component code
510	480	max. 370	4400	HX-N31810440
			4600	HX-N31810460
610	580	max. 470	4400	HX-N31820440
			4600	HX-N31820460
710	680	max. 570	4400	HX-N31830440
			4600	HX-N31830460
810	780	max. 670	4400	HX-N31840440
			4600	HX-N31840460
910	880	max. 770	4400	HX-N31850440
			4600	HX-N31850460

Commercial depth Gh	Depth Gz [mm]	Integration Gh shelf	Height H [mm]	Component code
510	480	max. 370	4400	HX-N33810440
610	580	max. 470	4400	HX-N33820440
710	680	max. 570	4400	HX-N33830440
810	780	max. 670	4400	HX-N33840440
910	880	max. 770	4400	HX-N33850440

TWO-SIDED INTEGRATION

TWO-SIDED INTEGRATION - GONDOLA IN ONE FRAME



Commercial depth Gh	Depth Gz	Integration Gh shelf	Height H [mm]	Component code
HX 82 0185				
930	900	2 x 370	4000	HX-N31250400
930	900	2 x 370	4200	HX-N31250420
1130	1100	2 x 470	4000	HX-N31380400
1130	1100	2 x 470	4200	HX-N31380420
1330	1300	2 x 570	4000	HX-N31490400
1330	1300	2 x 570	4200	HX-N31490420
HX 102 0185 (S)				
930	900	2 x 370	4200	HX-N29250420
930	900	2 x 370	4800	HX-N29250480
1130	1100	2 x 470	4000	HX-N29380400
1130	1100	2 x 470	4200	HX-N29380420
1330	1300	2 x 570	4000	HX-N29490400
HX 102 0220 (ZZS)				
930	900	2 x 370	4600	HX-N33250460
930	900	2 x 370	5000	HX-N33250500
1130	1100	2 x 470	4600	HX-N33380460
1130	1100	2 x 470	4800	HX-N33380480
1330	1300	2 x 570	4600	HX-N33490460
1330	1300	2 x 570	4800	HX-N33490480

BEAMS FOR REDUCED DEPTH

SINGLE INTEGRATION WITH REDUCED DEPTH OR TWO-SIDED SYMMETRICAL

- use 2 pcs to H = 2300
- use 3 pcs from H = 2300 to 2500

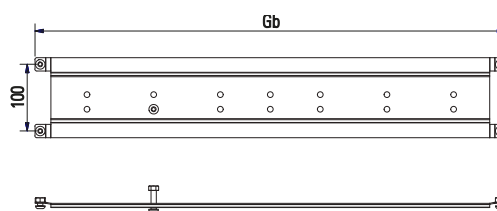
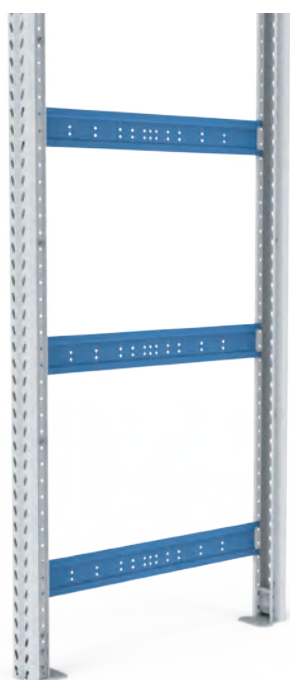

Commercial depth Gh	Depth Gb [mm]	Component code
810	686	HX-A10110810
830	706	HX-A10110830
910	786	HX-A10110910
930	806	HX-A10110930
1010	886	HX-A10111010
1050	926	HX-A10111050
1130	1006	HX-A10111130
1150	1026	HX-A10111150
1330	1206	HX-A10111330

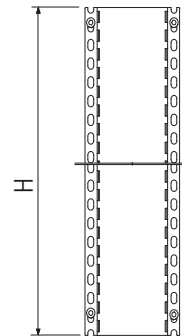
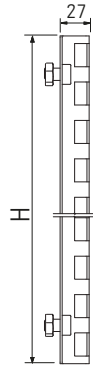

SINGLE

Height H [mm]	Component code
500	HX-A04660050
600	HX-A04660060
700	HX-A04660070
800	HX-A04660080
900	HX-A04660090
1000	HX-A04660100
1100	HX-A04660110
1200	HX-A04660120
1300	HX-A04660130
1400	HX-A04660140
1500	HX-A04660150
1600	HX-A04660160
1700	HX-A04660170
1800	HX-A04660180
1900	HX-A04660190
2000	HX-A04660200
2100	HX-A04660210
2200	HX-A04660220
2300	HX-A04660230
2400	HX-A04660240
2500	HX-A04660250

TWO-SIDED

Height H [mm]	Component code
900	HX-A04610090
1000	HX-A04610100
1100	HX-A04610110
1200	HX-A04610120
1300	HX-A04610130
1400	HX-A04610140
1500	HX-A04610150
1600	HX-A04610160
1700	HX-A04610170
1800	HX-A04610180
1900	HX-A04610190
2000	HX-A04610200
2100	HX-A04610210
2200	HX-A04610220
2300	HX-A04610230
2400	HX-A04610240
2500	HX-A04610250

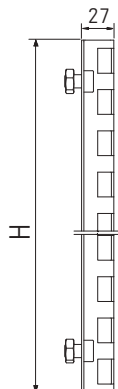

SINGLE

Height H [mm]	Component code
500	HX-A04690050
600	HX-A04690060
700	HX-A04690070
800	HX-A04690080
900	HX-A04690090
1000	HX-A04690100
1100	HX-A04690110
1200	HX-A04690120
1300	HX-A04690130
1400	HX-A04690140
1500	HX-A04690150
1600	HX-A04690160
1700	HX-A04690170
1800	HX-A04690180
1900	HX-A04690190
2000	HX-A04690200
2100	HX-A04690210
2200	HX-A04690220
2300	HX-A04690230

TWO-SIDED

Height H [mm]	Component code
900	HX-A04710090
1000	HX-A04710100
1100	HX-A04710110
1200	HX-A04710120
1300	HX-A04710130
1400	HX-A04710140
1500	HX-A04710150
1600	HX-A04710160
1700	HX-A04710170
1800	HX-A04710180
1900	HX-A04710190
2000	HX-A04710200
2100	HX-A04710210
2200	HX-A04710220
2300	HX-A04710230
2400	HX-A04710240
2500	HX-A04710250

LOWER BRACKET FOR INTEGRATION

DOUBLE INTEGRATION 2 FRAMES

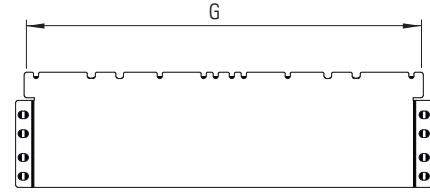
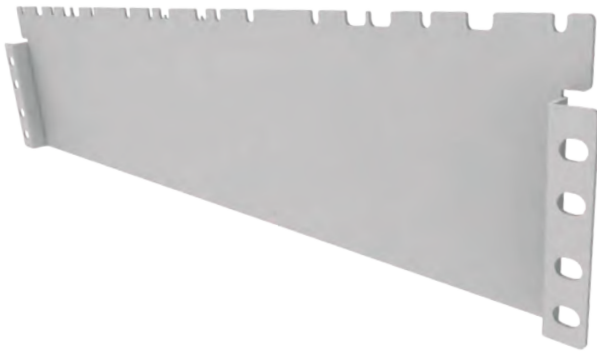

Commercial depth Gh	Bracket depth G [mm]	Commercial depth shelf	Component code
510	388	370	HX-A04500370
610	488	470	HX-A04500470
710	588	570	HX-A04500570
810	688	670	HX-A04500670
910	788	570 + 210	HX-A04500770

BASELEG FOR INTEGRATION

DOUBLE INTEGRATION IN ONE FRAME FOR PERFORATION 50 MM

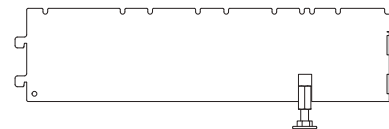
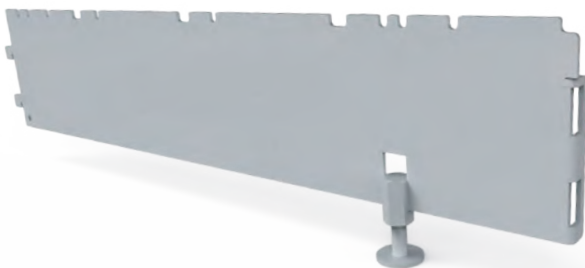

Commercial depth Gh	Component code/right	Component code/left
370	HX-A10120370	HX-A10130370
470	HX-A10120470	HX-A10130470
570	HX-A10120570	HX-A10130570
670	HX-A10120670	HX-A10130670
770	HX-A10120770	HX-A10130770

PALLET SAFETY SIDE STOP

PALLET SAFETY SIDE STOP BRACKET

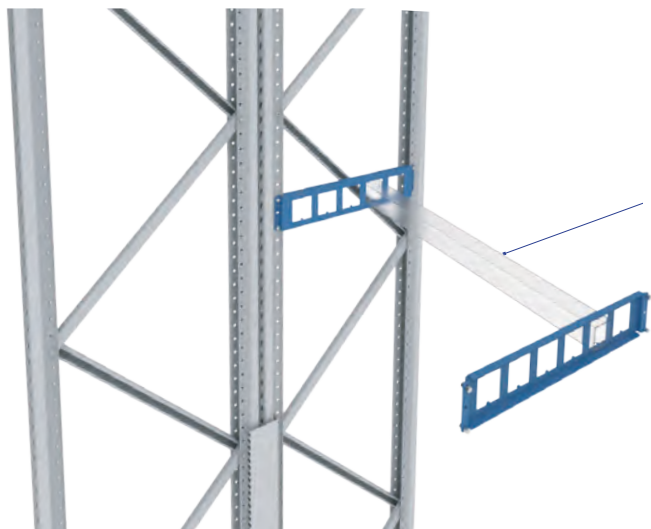

HX-Z01122730
for crossbeam
LH-2700

Commercial depth Gh	Depth Gb [mm]	Component code
510	390	HX-Z01100510
610	490	HX-Z01100610
710	590	HX-Z01100710
810	690	HX-Z01100810
910	790	HX-Z01100910
1010	890	HX-Z01101010

SAFETY TUBE

Length L	Lh crossbeam	Component code
2018	1998	HX-Z01122028
2528	2498	HX-Z01122528
2693	2663	HX-Z01122693
2730	2700	HX-Z01122730

END CAP

BAR FOR END CAP



Commercial depth Gh	Depth Gb [mm]	Component code
510	338	HX-A04900510
600	428	HX-A04900600
610	438	HX-A04900610
630	458	HX-A04900630
650	478	HX-A04900650
710	538	HX-A04900710
1000	828	HX-A04901000
1050	878	HX-A04901050
1130	958	HX-A04901130
1230	1058	HX-A04901230

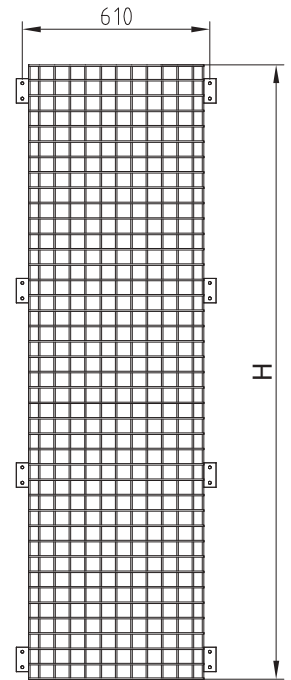
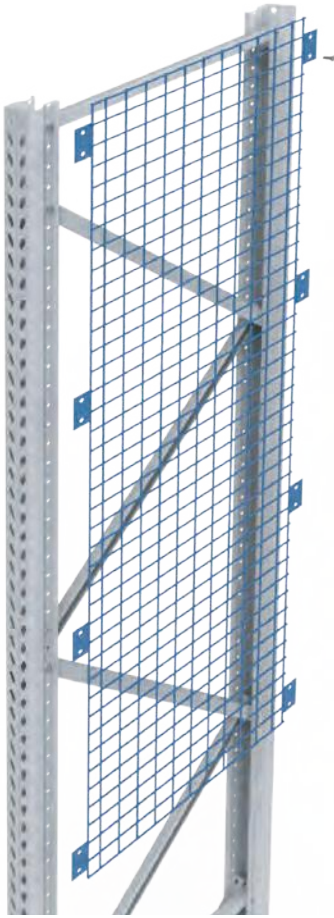

GRATE ON FRAME HX (82, 102, 122)

Frame Gh	Gz [mm] Gz=Gh-30	Gk [mm]	Height grate H [mm]	Code
750	720	610	2000	HX-A02192000
			2600	HX-A02192600
			3000	HX-A02193000
1050	1020	910	1800	HX-A02151800
			2000	HX-A02152000
			2100	HX-A02152100
			2500	HX-A02152500
			2800	HX-A02152800
			3000	HX-A02153000
1130	1100	990	2000	HX-A02682000
			2500	HX-A02682500
			2800	HX-A02682800
			3000	HX-A02683000

INTEGRATION - DIY SOLUTIONS





DIVIDER

Divider (prof. 18x30) on crossbeam 40x60, 80 L-... a set.

Dimension [mm]	Product code
L - 400	SP-T03700400
L - 500	SP-T03700500
L - 600	SP-T03700600
L - 700	SP-T03700700
L - 800	SP-T03700800
L - 900	SP-T03700900
L - 1000	SP-T03701000

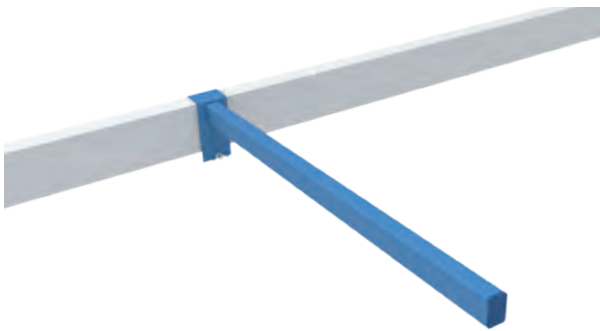

DIVIDER

Divider (prof.. 27x40) on crossbeam 40X100 a set.

Dimensions [mm]	Product code
L - 500	SP-T00430500
L - 600	SP-T00430600
L - 700	SP-T00430700
L - 800	SP-T00430800
L - 900	SP-T00430900

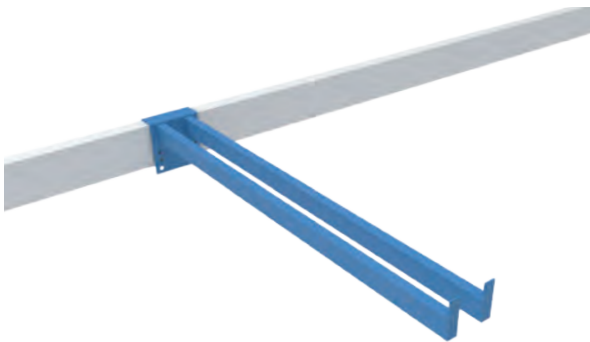

DUAL DIVIDER

Double divider 20x40 on crossbeam 40x...

Dimensions [mm]	Product code
L - 600	SP-T33000600
L - 900	SP-T33000900

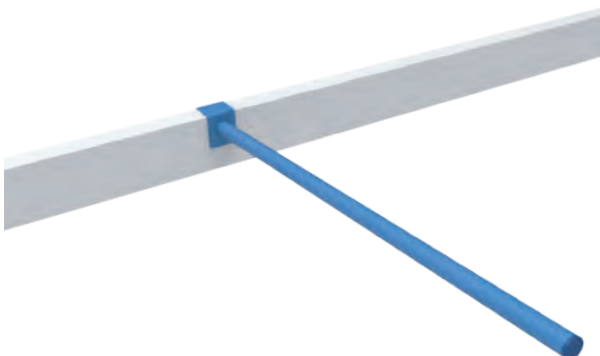

DIVIDER

Hanger / Divider on crossbeam 40x60

Dimensions [mm]	Product code
G-300, D-25	SP-T00110300
G-400, D-25	SP-T00110400
G-550, D-25	SP-T00110550
G-650, D-25	SP-T00110650
G-750, D-25	SP-T00110750
G-950, D-25	SP-T00110950
G-1050, D-25	SP-T00111050

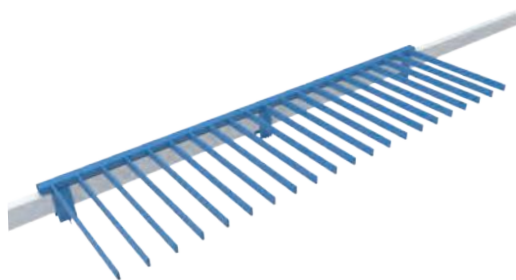

COMB DIVIDER

Comb Divider G-540
on crossbeam 40x60/80/100 L-...

Dimension [mm]	Product code
L - 1000	SP-T10531000
L - 1300	SP-T10531300
L - 2000	SP-T10532000
L - 2300	SP-T10532300
L - 2500	SP-T10532500
L - 2700	SP-T10532700
L - 3600	SP-T10533600
L - 3700	SP-T10533700

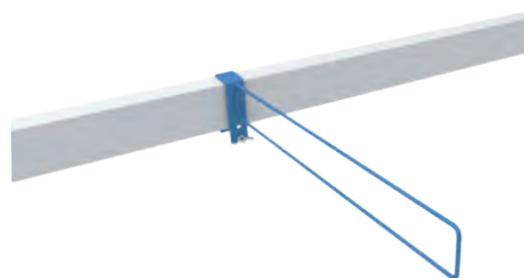

DOUBLE WIRE DIVIDER

Double wire divider
100x40, a set

Dimension [mm]	Product code
L - 350	SP-T03520350
L - 400	SP-T03520400
L - 500	SP-T03520500
L - 590	SP-T03520590
L - 600	SP-T03520600
L - 650	SP-T03520650
L - 800	SP-T03520800
L - 900	SP-T03520900

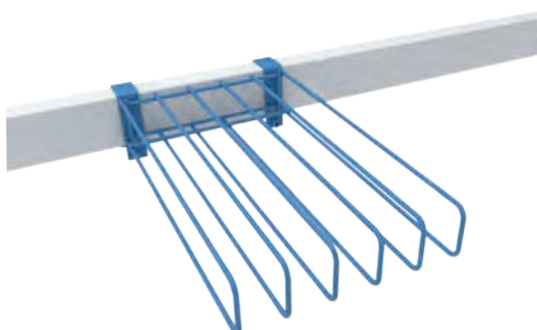

DIVIDER FOR CURTAIN RAILS

Divider for curtain rails (5 partition)
G-440 L-256 crossbeam 40x80
with screw-a set

Dimension [mm]	Product code
L - 256, G-440	SP-T46300440

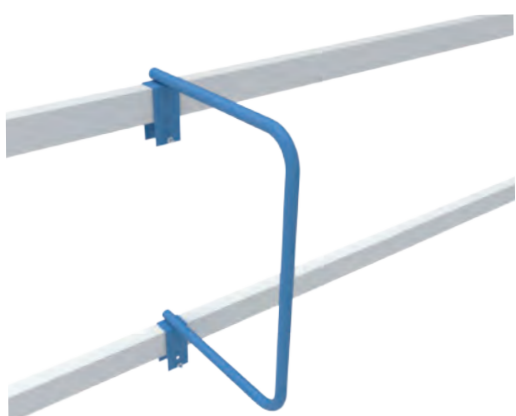

SEPARATOR

Divider H-600 i 700 D-25 mm
crossbeam 40x...-a set

Dimension [mm]	Product code
CROSSBEAM 40 X 60/80/100	
G-500 H-600	SP-T02330500
G-700 H-600	SP-T02330700
G-1000 H-600	SP-T03030600
CROSSBEAM 40 X 100	
G-600 H-700	SP-T03030600
G-800 H-700	SP-T03030800
G-1000 H-700	SP-T03040700
CROSSBEAM 40 X 120	
G-700 H-700	SP-T03040700
G-1000 H-700	SP-T03041000

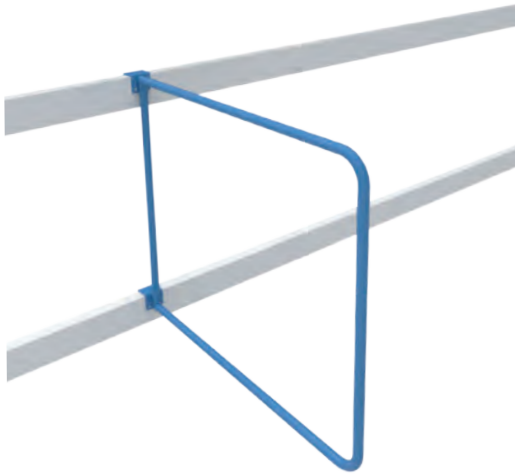

DIVIDER

Divider H-800 i 1000 D-25 mm
on crossbeam 40x... a set

Dimension [mm]	Product code
H-800	
G-500	SP-T02210500
G-600	SP-T02210600
G-800	SP-T02210800
H-1000	
G-500	SP-T02430500
G-600	SP-T02430600
G-800	SP-T02430800

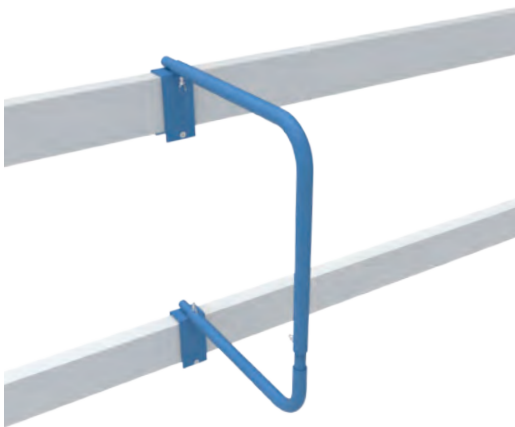

ADJUSTABLE DIVIDER

Adjustable divider on crossbeam
40x60, 80, 100 G-(400-700) H-(500-700) a set

Dimension [mm]	Product code
G - (400-700), H - (500-700) on crossbeam 40x 60, 80, 100	SP-T50400000

DIAGONAL DIVIDER FOR THE PURPOSE OF EXPOSING PANELS ON CROSSBEAM 40X100

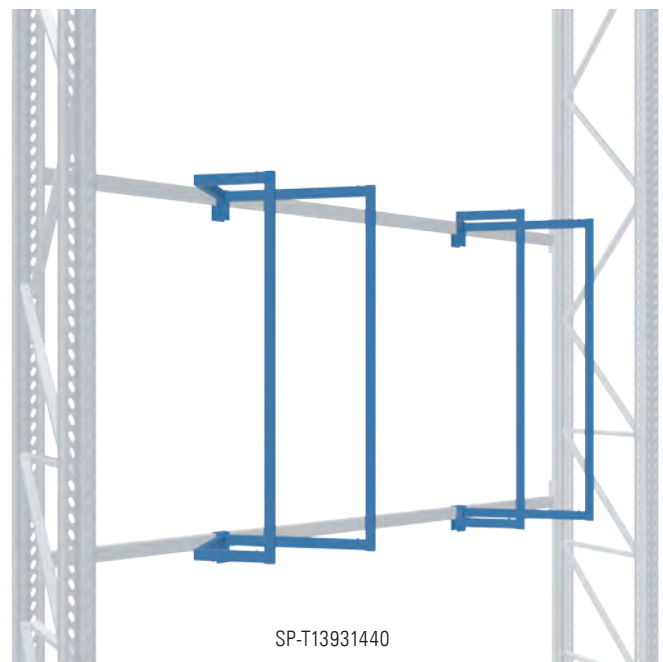
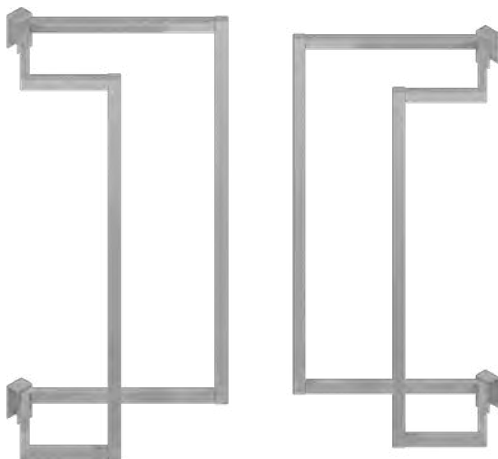

SP-T13931440

Dimension [mm]	Product code
Right H - 1440	SP-T13931440
LeftH - 1440	SP-T13831440

DIVIDERS AND FRONT SAFEGUARDS



DIVIDER

Divider on crossbeam 40x...

Product code
SP-T26431050

SAFEGUARD-LIMITER BEAM



LOWER

Dimensions [mm]	Product code
Prof. 27x40 / L - 1800	MX-Z00381800
Prof. 27x40 / L - 2700	MX-Z00382700



UPPER

Dimensions [mm]	Product code
Prof. 27x40 / L - 1800	MX-Z00391800
Prof. 27x40 / L - 2700	MX-Z00392700

FRONT RACK SAFEGUARD WITH A REMOVABLE BEAM (PIPE)

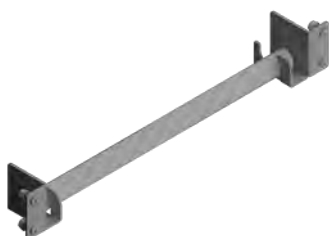

Dimensions [mm]	Product code
L - 1800	HX-A06091800
L - 2700	HX-A06092700

FRONT RACK SAFEGUARD WITH A REMOVABLE BEAM (PROFILE)



Depth D [mm]	Length L [mm]	Product code
120	1800	HX-A01201800
120	1800	HX-A01202700

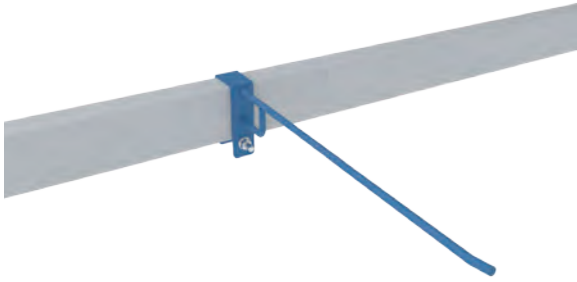

HANGER STRAIGHT SUPPORTED

On crossbeam 40x60

Dimension [mm]	Product code
L - 200, D - 8	WB-T01208200
L - 300, D - 8	WB-T01208300
L - 400, D - 8	WB-T01208400

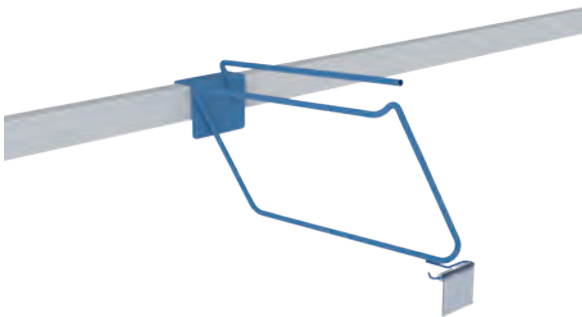

HAMMERS HANGER

On bar 27x40

Product code
WB-A52200350

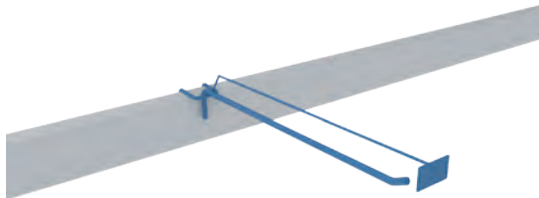

HANGER STRAIGHT WITH LABEL; 50X30

Hanger on crossbeam 40x...

Dimension [mm]	Product code
L - 200, D - 8	WB-T00308200
L - 300, D - 8	WB-T00308300
L - 400, D - 8	WB-T00308400
L - 500, D - 8	WB-T00308500
L - 500, D - 10	WB-T00310500

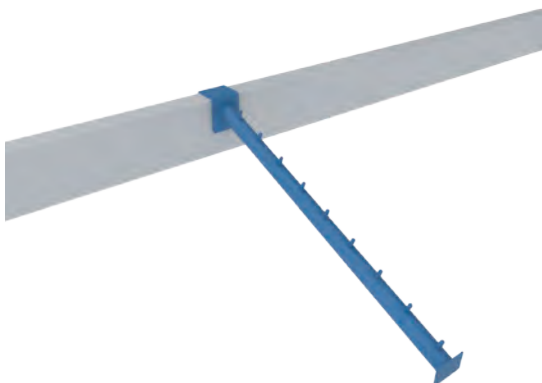

HANGER DIAGONAL

Hanger on crossbeam 40x...

Dimension [mm]	Product code
L - 500, D - 25	WB-T04125500

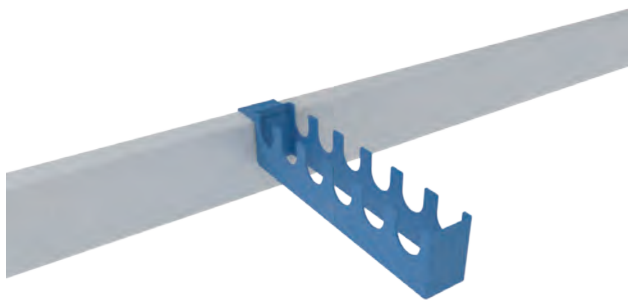

AXE HANGERS

Hanger on cross-beam 40x... /LEFT/

Dimensions [mm]	Product code
L-400	WB-T10402400

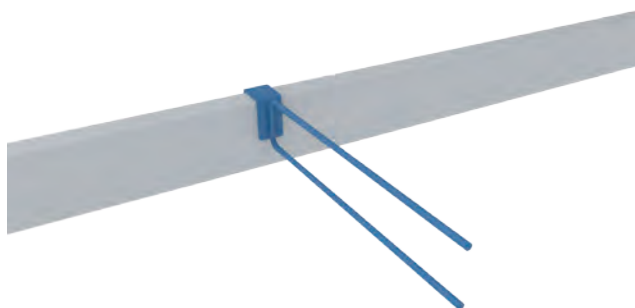

AXE HANGER

Hanger on crossbeam 40x60 /RIGHT/

Dimensions [mm]	Product code
L-400	WB-T03708400

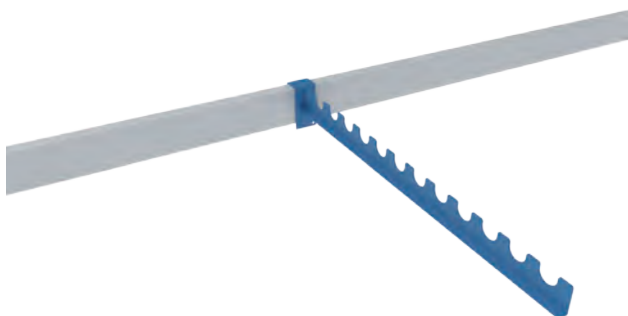

SHOVEL HANGER

Hanger on crossbeam 40x60/80/100

Dimensions [mm]	Product code
L-590	WB-T06300590
L-800	WB-T06300800

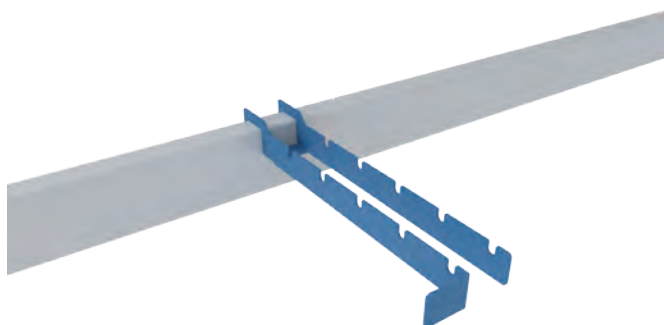

FORK HANGER

Hanger on crossbeam 40x.. double, with openings L-...

Dimensions [mm]	Product code
L-400	WB-T10803400
L-500	WB-T10803500



SINKS HANGER

Hanger for standar crossbeam(40 x 100 mm) for sinks moved away o 200 mm (a handle clad with rubber) L-490

Dimensions [mm]	Product code
H = min 440 - max 650	WB-T06500490
G = min 405 – max 600	

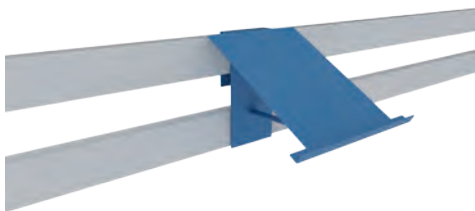

TOILET BOWL HANGER

Toilet bowl hanger on crossbeam 40x100

Product code
MR-A04060400



BATHROOM FAUCETS HANGER

Hanger on back panel

Dimensions [mm]	Product code
L-390	WP-A11200390

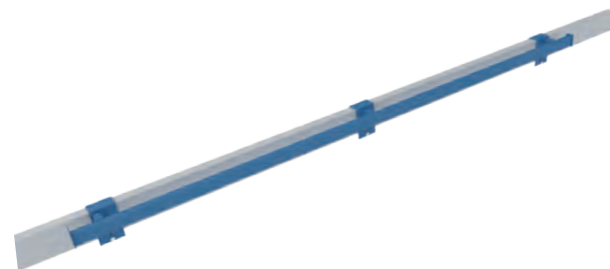

BEAM

Beam 27x40 screwed 40X(60,80,100) a set

Dimensions [mm]	Product code
L-1500	MR-B01201500
L-1800	MR-B01201800
L-2500	MR-B01202500
L-2700	MR-B01202700
L-3030	MR-B01203030

IMPORTANT NOTE

The abovementioned solution allows making use of the entire range of hangers offered by Mago S.A., dedicated to a 27x40 beam (please find several exaples below).

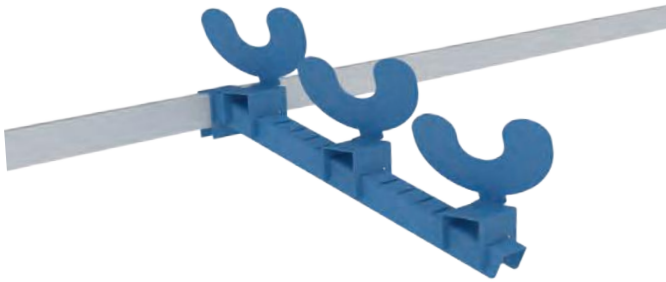

GRINDERS HANGER

Hanger on bar 20x50

Product code

WB-A81700425

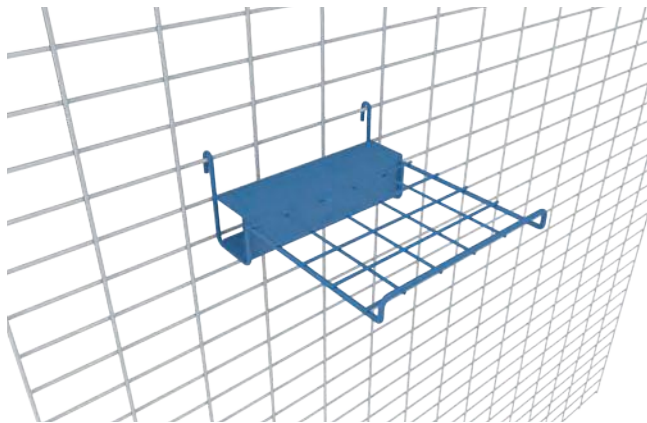

CIRCULAR SAWS HANGER

Grating hanger

Product code

WK-R04000245

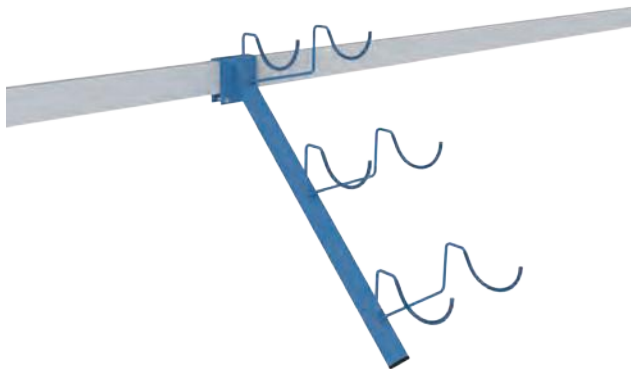

DRILL HANGER

Hanger on bar 20x50

Product code

WB-A82500500

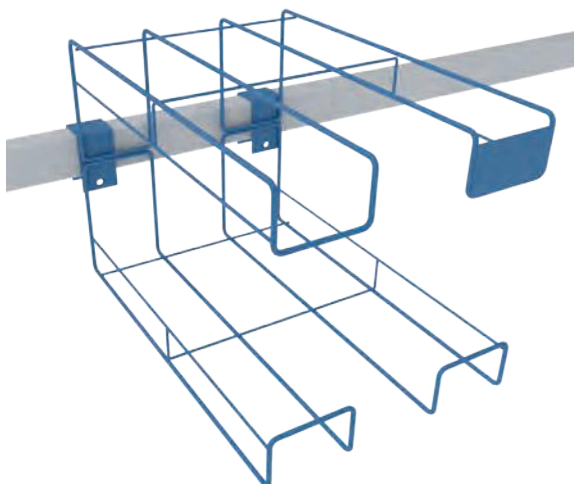

PILLOW DISPLAY

On crossbeam 40x60 mm

Dimensions
[mm]

G-490, L-320, H-340

Product code

MR-A61500490

PERFORATED DOOR WITH A LOCK

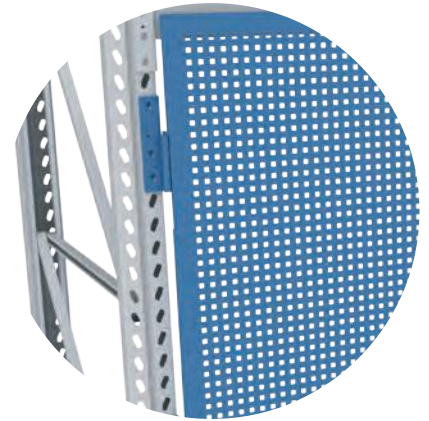

Dimensions [mm]	Product code
H-800 / L-1800	MX-A02560800
H-1250 / L-1800	MX-A02561250
H-800 / L-2700	MX-A02520800
H-1250 / L-2700	MX-A02521250

HINGES

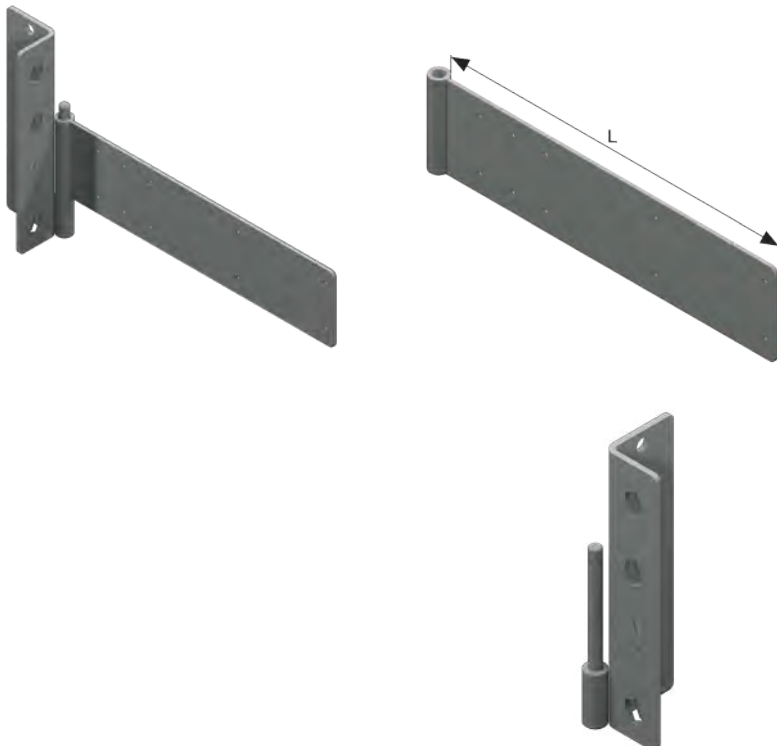

PANEL MOUNTING HINGES (LEFT, RIGHT)

Dimensions [mm]	Product code
H-75 / L-75	MX-A00290075
H-75 / L-100	MX-A00290100
H-75 / L-300	MX-A00290300
H-75 / L-850	MX-A00290850
H-75 / L-1000	MX-A00291000

HINGE PAW

Dimensions [mm]	Product code
Left	MX-A01300150
Right	MX-A01310150

PANEL HOLDER 18 MM



PANEL HOLDER, UPPER

On crossbeam 40x100/120/140 mm

Dimensions [mm]	Product code
L - 1790	MR-A10631790
L - 2690	MR-A10632690

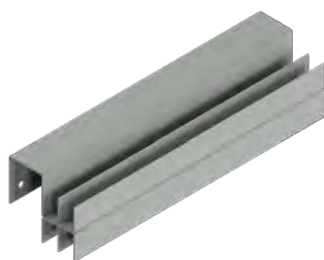

PANEL HOLDER, MIDDLE

On crossbeam 40x100/120/140 mm

Dimensions [mm]	Product code	Q max
L - 1790	MR-A10621790	80 kg
L - 2690	MR-A10622690	120 kg



PANEL HOLDER, LOWER

On crossbeam 40x100/120/140 mm

Dimensions [mm]	Product code	Q max
L - 1790	MR-A106111790	80 kg
L - 2690	MR-A10612690	120 kg

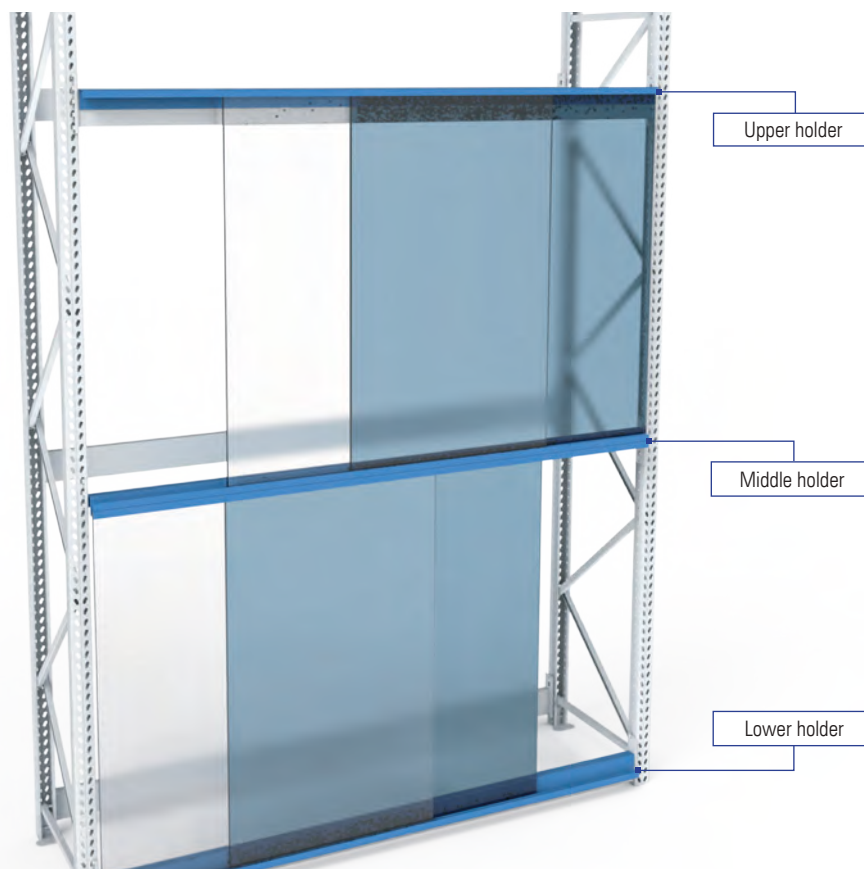

SLIDE (UPPER, MIDDLE, LOWER)



UPPER ON CROSSBEAM 40X100/120/140 MM

Dimensions [mm]	Product code	Qmax
L – 2700, panel L-950	MR-A71422700	150 kg



MIDDLE ON CROSSBEAM 40X100/120/140 MM

Dimensions [mm]	Product code	Qmax
L – 2700, panel L-950	MR-A71432700	150 kg



LOWER ON CROSSBEAM 40X100/120/140

Dimensions [mm]	Product code
L – 2700, panel L-950	MR-A7144270

DOUBLE-SIDED FOR PERFORATED PANELS



Dimensions	Product code
Frame depth D-750	HX-A00200750
Frame depth D-1050	HX-A00201050
Frame depth D-1130	HX-A00201130

PERFORATED PANEL FOR SINGLE BEARER

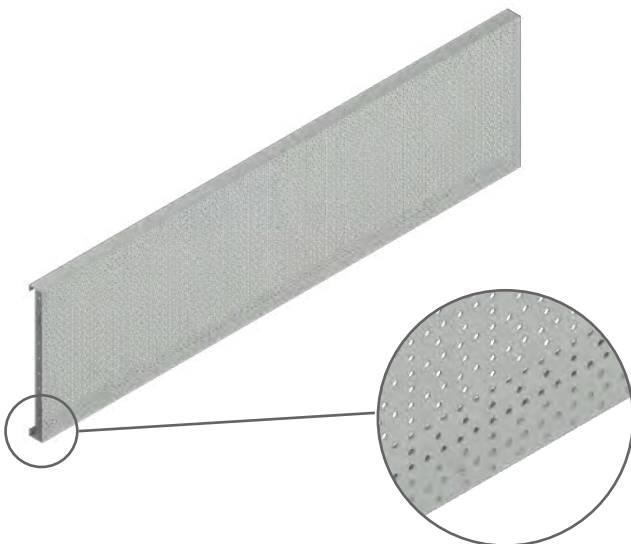

Dimensions [mm]	Product code
L-1800, H-500	MX-A00151800
L-2700, H-500	MX-A00152700

RACK WITH REDUCED DEPTH

WALL WITH BACK PANELS H-2200

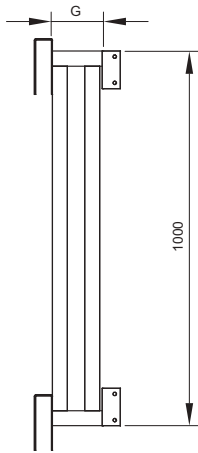
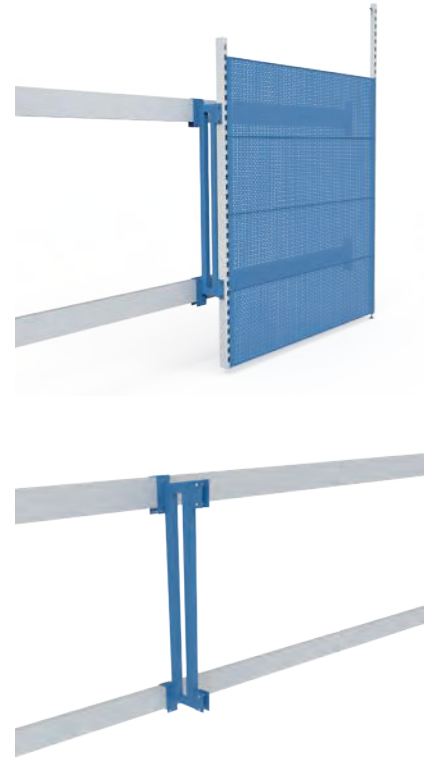

FRAME FOR PROFILE 60X30 G-300 H-1000 ON CROSSBEAM 120X40

Component code
NX-A00980300

PROFILE 60X30

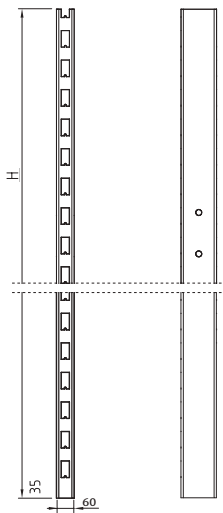

PROFILE 60X30 BILATERAL PERFORATED FOR HANDLE NX-A0098

Component code	H
ME-N66106220	2200

PROMOTIONAL HANGERS

PROMOTIONAL PURCHASE L-1150

Component code

MR-A05010000

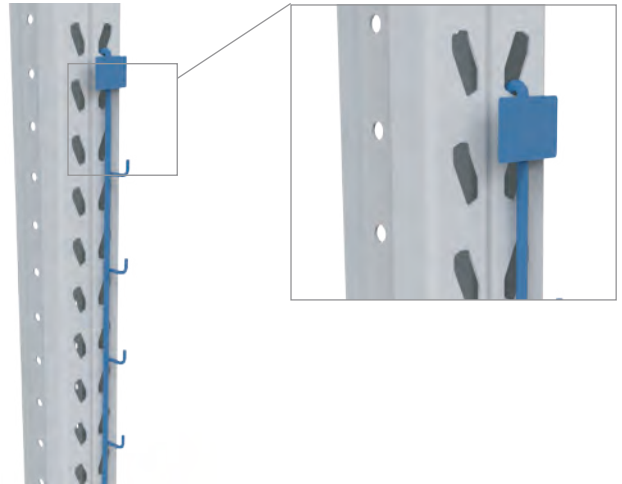

HANGER TO BLISTER PACKS L-1140

Component code

MR-A05041140

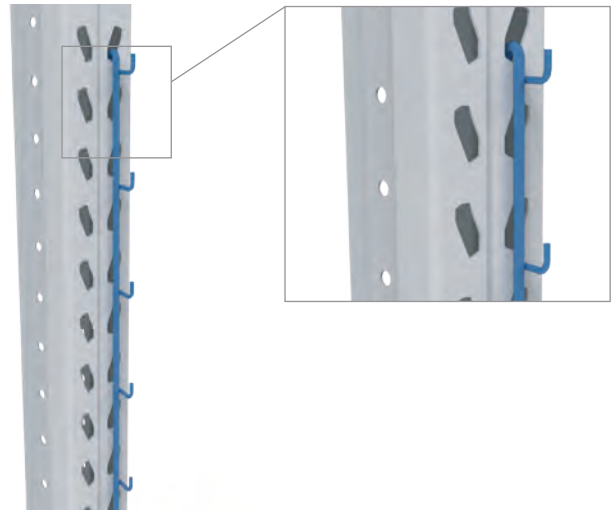

HANGER TO PLISTER PACKS WITH A PRICE HOLDER L-1140

Component code

MR-A05061140

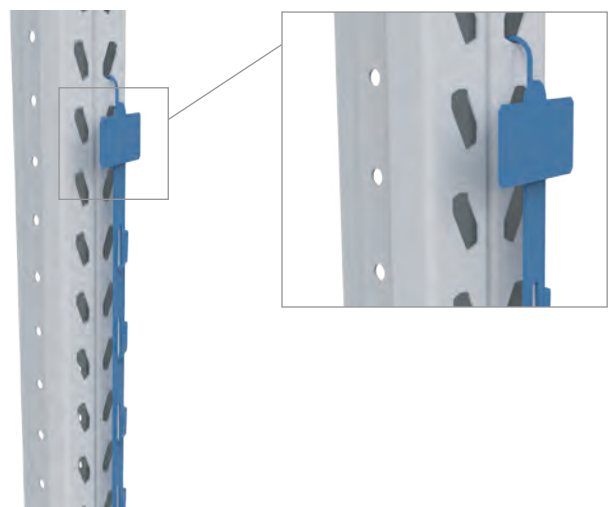

CASH & CARRY SOLUTIONS



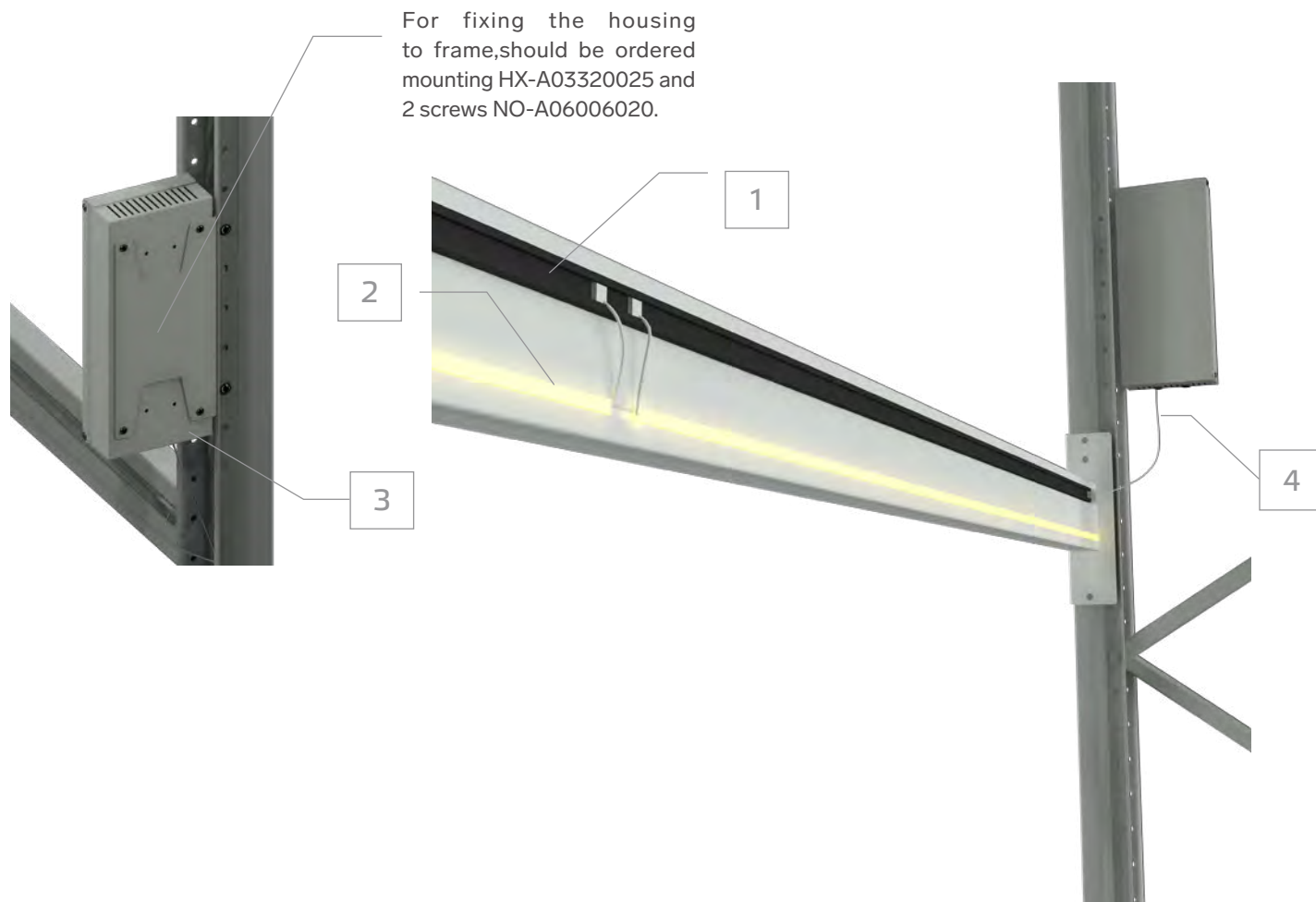

No.	Description	Dimensions [mm]	Code
1.	Power track with magnet for LED lighting	L-2000 L-2400 L-2500	S2000000000M-OS S2400000000M-OS S2500000000M-OS
2.	Lighting LED strip 9,5W 24V Lighting LED strip 11,9W 24V Lighting LED strip 12,7W 24V	4000K L-1000 (980) L-1250 (1230) L-1330	L1000M0W09V2400-OS L1250M0W09V2400-OS L1330M0W09V2400-OS
3.	Power system of lighting for HX racks Power system of lighting (5 socket 3M 230V)	150W / 24V 150W / 24V	UZ0000000001 UZ0000000005
4.	Connecting cable	1,5 m 0,5 m 3 m	UK0000000001 UK0000000002 UK0000000004
5.	Connector of power tracks between HX units	LS0000000000-OS	LS0000000000-OS

DIVIDER FOR BRACKET STEPPED

H-100



Commercial depth Dh	Depth D [mm]	Product code
750	668	HX-A14450750
1050	968	HX-A14451050
1130	1048	HX-A14451130

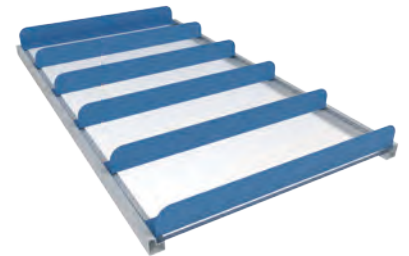

DIVIDERS FOR BRACKET RECTANGULAR 40x...

H-100



Commercial depth Dh	Depth D [mm]	Product code
750	668	HX-A14480750
1050	926	HX-A14481050
1130	1006	HX-A14481130



Z-BAR H-50 ON CROSSBEAM STEPPED

H-50



Commercial depth Dh	Depth D [mm]	Product code
1800	1780	HX-A03951780
1998	1980	HX-A03951780
2700	2680	HX-A03951780

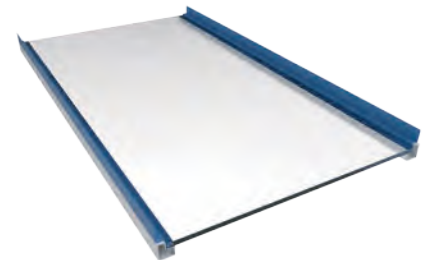



Code	Description
MK-P01551000	BASIS OF BASKETS MK-K...ON WHEELS G-550 L-1000
MK-K30551000	SPREAD BASKET SYSTEM H-300 G-550 L-1000
MK-K30501000	SPREAD BASKET SYSTEM H-300 G-500 L-1000
MK-K30451000	SPREAD BASKET SYSTEM H-300 G-450 L-1000
MK-K30401000	SPREAD BASKET SYSTEM H-300 G-400 L-1000
MK-N02381000	UPPER SECTION MK-K G-380 L-1000

DIVIDERS

ME-D00500550	BASKET DIVIDERS MK-K30 G-550
ME-D00500500	BASKET DIVIDERS MK-K30 G-500
ME-D00500450	BASKET DIVIDERS MK-K30 G-450
ME-D00500400	BASKET DIVIDERS MK-K30 G-400
ME-D00470380	UPPER SECTION DIVIDERS MK-N0238... G-380

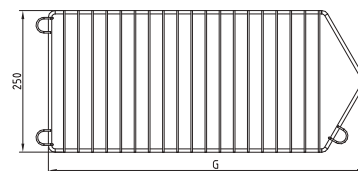

BASKET DIVIDER MK-K30

Depth D [mm]	Length L [mm]	Product code
450	250	ME-D00500450
550	250	ME-D00500550
800	250	ME-D00500800

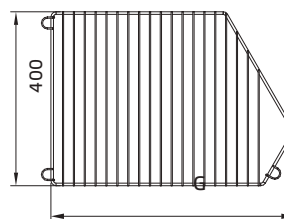

Depth D [mm]	Length L [mm]	Product code
450	1000	MK-K30451000
	1240	MK-K30451240
	1320	MK-K30451320
550	1000	MK-K30551000
	1240	MK-K30551240
	1320	MK-K30551320
800	1000	MK-K30801000
	1240	MK-K30801240
	1320	MK-K30801320

BASKET DIVIDER MK-K45

Depth D [mm]	Length L [mm]	Product code
450	400	ME-D00450450
550	400	ME-D00450550
800	400	ME-D00450800



BASIS OF BASKET MK-K ON WHEELS

Dimensions [mm]	Product code
G-550 L-1300	MK-P01551300



Depth D [mm]	Length L [mm]	Product code
450	1000	MK-K45451000
	1240	MK-K45451240
	1320	MK-K45451320
550	1000	MK-K45551000
	1240	MK-K45551240
	1320	MK-K45551320
800	1000	MK-K45801000
	1240	MK-K45801240
	1320	MK-K45801320

PROMO STANDS - MARKETING COMMUNICATIONS



Product code
AA-000500221

INFORMATION CANOPY



Height H	Product code
300	ME-Z38341000
400	ME-Z38541000

MOBILE HANGER



Product code
AA-045700295

SMARTLINE
WINKELINTERIEUR

Tel: +31 (0)313 74 50 30

Imboslaan 130

6951 KC Dieren

info@smartline.sale

www.smartline.sale